



PROPERTY OF
THE NATIONAL COMMISSION
ON LABOR RELATIONS

PROPERTY OF
THE NATIONAL COMMISSION
ON LABOR RELATIONS

PROPERTY OF
LUCAS COMPANY
ARTHUR MITCHELL
U. S. N. R.

PROPERTY OF
LIEUT. COMDR.
ARTHUR BATCHELLER
U. S. N. R.

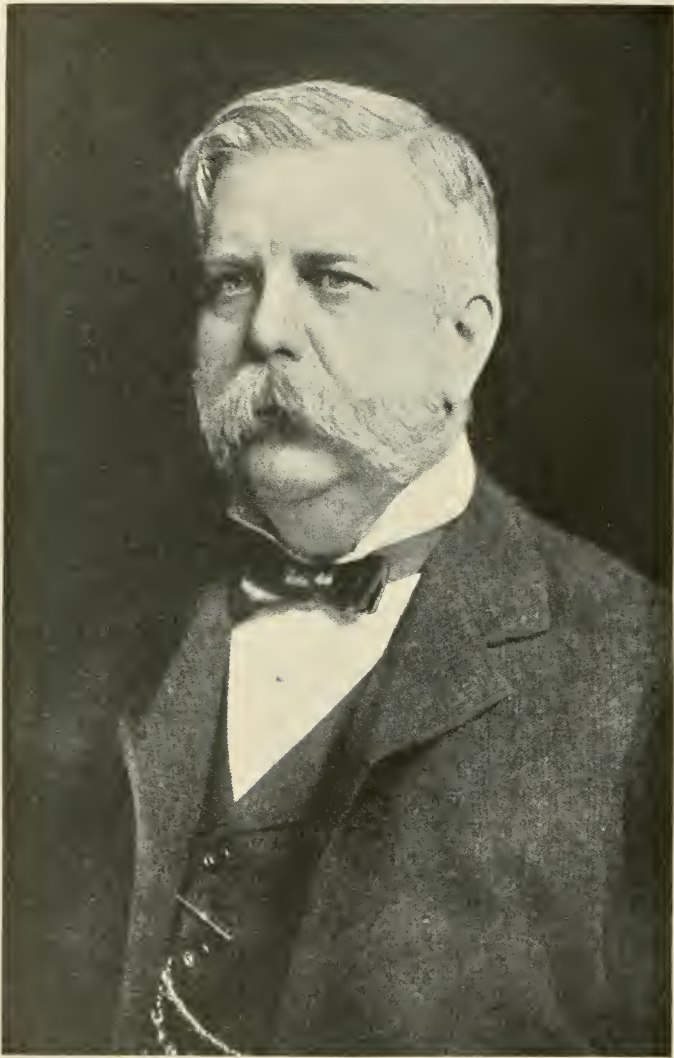

GEORGE WESTINGHOUSE

Inventor of Westinghouse Air Brake and Numerous Other Electrical and Mechanical Devices. Pioneer in Introducing Alternating-Current Machinery in America.

Cyclopedia
of
Applied Electricity

A General Reference Work on

DIRECT-CURRENT GENERATORS AND MOTORS, STORAGE BATTERIES,
ELECTROCHEMISTRY, WELDING, ELECTRIC WIRING, METERS,
ELECTRIC LIGHTING, ELECTRIC RAILWAYS, POWER
STATIONS, SWITCHBOARDS, POWER TRANSMIS-
SION, ALTERNATING-CURRENT
MACHINERY, TELEG-
GRAPHY, ETC.

Prepared by a Corps of

ELECTRICAL EXPERTS, ENGINEERS, AND DESIGNERS OF THE HIGHEST
PROFESSIONAL STANDING

Illustrated with over Two Thousand Engravings

SEVEN VOLUMES

CHICAGO
AMERICAN TECHNICAL SOCIETY
1916

COPYRIGHT, 1905, 1906, 1908, 1909, 1911, 1913, 1914, 1916

BY

AMERICAN TECHNICAL SOCIETY

COPYRIGHT, 1905, 1906, 1908, 1909, 1911, 1913, 1914, 1916

BY

AMERICAN SCHOOL OF CORRESPONDENCE

Copyrighted in Great Britain

All Rights Reserved

Authors and Collaborators

FRANCIS B. CROCKER, E. M., Ph. D.

Professor of Electrical Engineering, Columbia University, New York
Past-President, American Institute of Electrical Engineers



WILLIAM ESTY, S. B., M. A.

Head, Department of Electrical Engineering, Lehigh University
Joint Author of "The Elements of Electrical Engineering"



HENRY H. NORRIS, M. E.

Formerly Professor of Electrical Engineering, Cornell University
Secretary, Society for the Promotion of Engineering Education
Chairman, Educational Committee, American Electric Railway Association



GEORGE C. SHAAD, E. E.

Professor of Electrical Engineering, University of Kansas



ROBERT ANDREWS MILLIKAN, Ph. D., Sc. D.

Professor of Physics, University of Chicago
Co-Author of "First Course in Physics"
Author of "Mechanics, Molecular Physics and Heat," and Co-Author of "Electricity,
Sound and Light"
Member, American Physical Society



KEMPSTER B. MILLER, M. E.

Consulting Engineer
Of the Firm of McMeen & Miller, Electrical Engineers, Chicago



LOUIS DERR, S. B., A. M.

Professor of Physics, Massachusetts Institute of Technology



CHARLES F. BURGESS, E. E.

Formerly Professor of Chemical Engineering and Applied Electrochemistry, University of Wisconsin
Past President, American Electrochemical Society
Member, American Institute of Electrical Engineers, American Chemical Society,
Society of Chemical Industry, Western Society of Engineers
President, Northern Chemical Engineering Laboratories

Authors and Collaborators—Continued

MORTON ARENDT, E. E.

Assistant Professor of Electrical Engineering, Columbia University, New York
American Institute of Electrical Engineers



GEORGE W. PATTERSON, S. B., Ph. D.

Head, Department of Electrical Engineering, University of Michigan



WILLIAM H. FREEDMAN, C. E., E. E., M. S.

Head, Department of Electrical Engineering, University of Vermont
Formerly Head, Department of Applied Electricity, Pratt Institute



DANA PIERCE, B. A.

Electrical Engineer, Underwriters' Laboratories, Inc.



CHARLES G. ASHLEY

Electrical Engineer, and Expert in Wireless Telephony and Telegraphy



GEORGE S. MACOMBER, M. E.

Assistant Professor of Electrical Engineering, Cornell University
Formerly Instructor, Washington University
Formerly Engineer with Stromberg-Carlson Telephone Manufacturing Company



CHARLES E. KNOX, E. E.

Consulting Electrical Engineer
American Institute of Electrical Engineers



GEORGE W. CRAVENS

Mechanical and Electrical Engineer
Manager, Welding Apparatus Department, C. & C. Electric and Manufacturing
Company, Garwood, New Jersey
Member, Association of Railway Electrical Engineers
American Institute of Electrical Engineers



EDWARD B. WAITE

Dean and Head, Consulting Department, American School of Correspondence
Formerly Research Assistant, Harvard College Observatory
American Society of Mechanical Engineers
Western Society of Engineers



C. C. ADAMS, B. S.

Switchboard Engineer with General Electric Company

Authors and Collaborators—Continued

HUGO DIEMER, M. E.

Professor of Industrial Engineering, Pennsylvania State College
American Society of Mechanical Engineers

O. J. BUSHNELL

Superintendent, Meter Department, Commonwealth Edison Company

LAWRENCE K. SAGER, S. B., M. P. L.

Patent Attorney and Electrical Expert, New York City

JOHN H. JALLINGS

Mechanical Engineer
For Twenty Years Superintendent and Chief Constructor for J. W. Reedy Elevator Co.

DAVID P. MORETON, B. S., E. E.

Associate Professor of Electrical Engineering, Armour Institute of Technology
American Institute of Electrical Engineers

GLENN M. HOBBS, Ph. D.

Secretary and Educational Director, American School of Correspondence
Formerly Instructor in Physics, University of Chicago
American Physical Society

GEORGE R. METCALFE, M. E.

Editor, American Institute of Electrical Engineers
Formerly Head, Technical Publication Department, Westinghouse Electric & Manufacturing Company

A. G. TURNBULL

Meter Department, Commonwealth Edison Company

J. P. SCHROETER

Consulting Engineer, Department of Electrical Engineering, American School of Correspondence

CHAS. THOM

Chief, Quadruplex Department, Western Union Main Office, New York City

JESSIE M. SHEPHERD, A. B.

Head, Publication Department, American School of Correspondence

Authorities Consulted

THE editors have freely consulted the standard technical literature of America and Europe in the preparation of these volumes.* They desire to express their indebtedness, particularly to the following eminent authorities, whose well-known works should be in the library of every electrician and engineer.

Grateful acknowledgment is here made also for the invaluable co-operation of the foremost engineering firms and manufacturers in making these volumes thoroughly representative of the very best and latest practice in the design, construction, and operation of electrical machinery and instruments; also for the valuable drawings, data, suggestions, criticisms, and other courtesies.

FRANCIS B. CROCKER, E. M., Ph. D.

Professor of Electrical Engineering, Columbia University; Past-President, American Institute of Electrical Engineers
Author of "Electric Lighting"; Joint Author of "Management of Electrical Machinery," "Electric Motors"



SCHUYLER S. WHEELER, D. Sc.

President, Crocker-Wheeler Company; Past-President, American Institute of Electrical Engineers
Joint Author of "Management of Electrical Machinery"



ALFRED E. WIENER, E. E., M. E.

Member, American Institute of Electrical Engineers
Author of "Practical Calculation of Dynamo-Electric Machines"



WILLIAM S. FRANKLIN, M. S., D. Sc.

Professor of Physics, Lehigh University
Joint Author of "The Elements of Electrical Engineering," "The Elements of Alternating Currents"



WILLIAM ESTY, S. B., M. A.

Head of Department of Electrical Engineering, Lehigh University
Joint Author of "The Elements of Electrical Engineering"



R. B. WILLIAMSON

Joint Author of "The Elements of Alternating Currents"



HORATIO A. FOSTER

Consulting Engineer; Member of American Institute of Electrical Engineers; Member of American Society of Mechanical Engineers
Author of "Electrical Engineer's Pocket-Book"

*An extended list of books on Electrical Engineering may be found in Volume VII of this Cyclopedia.

Authorities Consulted—Continued

DUGALD C. JACKSON, C. E.

Head of Department of Electrical Engineering, Massachusetts Institute of Technology;
Member, American Society of Mechanical Engineers, American Institute of Electrical Engineers, etc.

Author of "A Textbook on Electromagnetism and the Construction of Dynamos"; Joint
Author of "Alternating Currents and Alternating-Current Machinery"

J. FISHER-HINNEN

Late Chief of the Drawing Department at the Oerlikon Works
Author of "Continuous-Current Dynamos"

WILLIAM L. HOOPER, Ph. D.

Head of Department of Electrical Engineering, Tufts College
Joint Author of "Electrical Problems for Engineering Students"

ROBERT ANDREWS MILLIKAN, Ph. D.

Professor of Physics, University of Chicago
Joint Author of "A First Course in Physics," "Electricity, Sound and Light," etc.

JOHN PRICE JACKSON, M. E.

Professor of Electrical Engineering, Pennsylvania State College; Member, American
Institute of Electrical Engineers, etc.
Joint Author of "Alternating Currents and Alternating-Current Machinery"

MICHAEL IDVORSKY PUPIN, A. B., Sc. D., Ph. D.

Professor of Electro-Mechanics, Columbia University, New York
Author of "Propagation of Long Electric Waves," and "Wave-Transmission Over Non-
Uniform Cables and Long-Distance Air Lines"

LAMAR LYNDON, B. E., M. E.

Consulting Electrical Engineer; Associate Member of American Institute of Electrical
Engineers; Member, American Electrochemical Society
Author of "Storage Battery Engineering"

EDWIN J. HOUSTON, Ph. D.

Professor of Physics, Franklin Institute, Pennsylvania; Joint Inventor of Thomson-
Houston System of Arc Lighting; Electrical Expert and Consulting Engineer
Joint Author of "Alternating Currents," "Arc Lighting," "Electric Heating," "Elec-
tric Motors," "Electric Railways," "Incandescent Lighting," etc.

ARTHUR E. KENNELLY, D. Sc.

Professor of Electrical Engineering, Harvard University
Joint Author of "Alternating Currents," "Arc Lighting," "Electric Heating,"
"Electric Motors," "Electric Railways," "Incandescent Lighting," etc.

Authorities Consulted—Continued

SILVANUS P. THOMPSON, D. Sc., B. A., F. R. S., F. R. A. S.

Principal and Professor of Physics in the City and Guilds of London Technical College;
Past-President, Institution of Electrical Engineers
Author of "Electricity and Magnetism," "Dynamo-Electric Machinery," "Polyphase
Electric Currents and Alternate-Current Motors," "The Electromagnet," etc.

KEMPSTER B. MILLER, M. E.

Consulting Engineer of the Firm of McMeen and Miller, Electrical Engineers, Chicago
Author of "American Telephone Practice"; Joint Author of "Telephony"

MAURICE A. OUDIN, M. S.

Member, American Institute of Electrical Engineers
Author of "Standard Polyphase Apparatus and Systems"

FREDERICK BEDELL, Ph. D.

Professor of Applied Electricity, Cornell University
Author of "The Principles of the Transformer"; Joint Author of "Alternating
Currents"

H. F. PARSHALL

Member of American Institute of Electrical Engineers, Institution of Electrical
Engineers, American Society of Mechanical Engineers, etc.
Joint Author of "Armature Windings of Electric Machines"

J. A. FLEMING, M. A., D. Sc. (London), F. R. S.

Professor of Electrical Engineering in University College, London; Late Fellow and
Scholar of St. John's College, Cambridge; Fellow of University College, London;
Member, Institution of Electrical Engineers; Member of the Physical Society of
London; Member of the Royal Institution of Great Britain, etc.
Author of "The Alternate-Current Transformer," etc.

LOUIS BELL, Ph. D.

Consulting Electrical Engineer; Lecturer on Power Transmission, Massachusetts In-
stitute of Technology
Author of "Electric Power Transmission," "Power Distribution for Electric Railways,"
"The Art of Illumination," "Wireless Telephony," etc.

CHARLES PROTEUS STEINMETZ

Consulting Engineer, with the General Electric Company; Professor of Electrical
Engineering, Union College
Author of "The Theory and Calculation of Alternating-Current Phenomena," "Theo-
retical Elements of Electrical Engineering," etc.

CYRILL M. JANSKY, B. S., E. A.

Associate Professor of Electrical Engineering, University of Wisconsin
Author of "Electric Meters"

Authorities Consulted—Continued

J. J. THOMSON, D. Sc., LL. D., Ph. D., F. R. S.

Fellow of Trinity College, Cambridge University; Cavendish Professor of Experimental Physics, Cambridge University
Author of "The Conduction of Electricity Through Gases," "Electricity and Matter," etc.

HENRY SMITH CARHART, A. M., LL. D.

Professor Emeritus of Physics, University of Michigan
Author of "Primary Batteries," "Elements of Physics," "University Physics," "Electrical Measurements," "High School Physics," etc.

F. A. C. PERRINE, A. M., D. Sc.

Consulting Engineer; Formerly President, Stanley Electric Manufacturing Company;
Formerly Manager, Insulated Wire Department, John A. Roebling's Sons Company
Author of "Conductors for Electrical Distribution"

WILLIAM MAVER, Jr.

Ex-Electrician, Baltimore & Ohio Telegraph Company
Author of "Wireless Telegraphy," "American Telegraphy and Encyclopedia of the Telegraph"

E. B. RAYMOND

Testing Department, General Electric Company
Author of "Alternating-Current Engineering"

AUGUSTUS TREADWELL, Jr., E. E.

Associate Member, American Institute of Electrical Engineers
Author of "The Storage Battery: A Practical Treatise on the Construction, Theory, and Use of Secondary Batteries"

SAMUEL SHELDON, A. M., Ph. D.

Professor of Physics and Electrical Engineering, Polytechnic Institute of Brooklyn
Joint Author of "Dynamo-Electric Machinery," "Alternating-Current Machines"

HOBART MASON, B. S., E. E.

Assistant in Electrical Engineering, Polytechnic Institute of Brooklyn; Associate Member, American Institute of Electrical Engineers
Joint Author of "Dynamo-Electric Machinery," "Alternating-Current Machines"

H. M. HOBART, B. Sc.

Member, Institution of Civil Engineers, American Institute of Electrical Engineers
Joint Author of "Armature Construction"

ALBERT CUSHING CREHORE, A. B., Ph. D.

Electrical Engineer; Assistant Professor of Physics, Dartmouth College
Author of "Synchronous and Other Multiple Telegraphs"; Joint Author of "Alternating Currents"

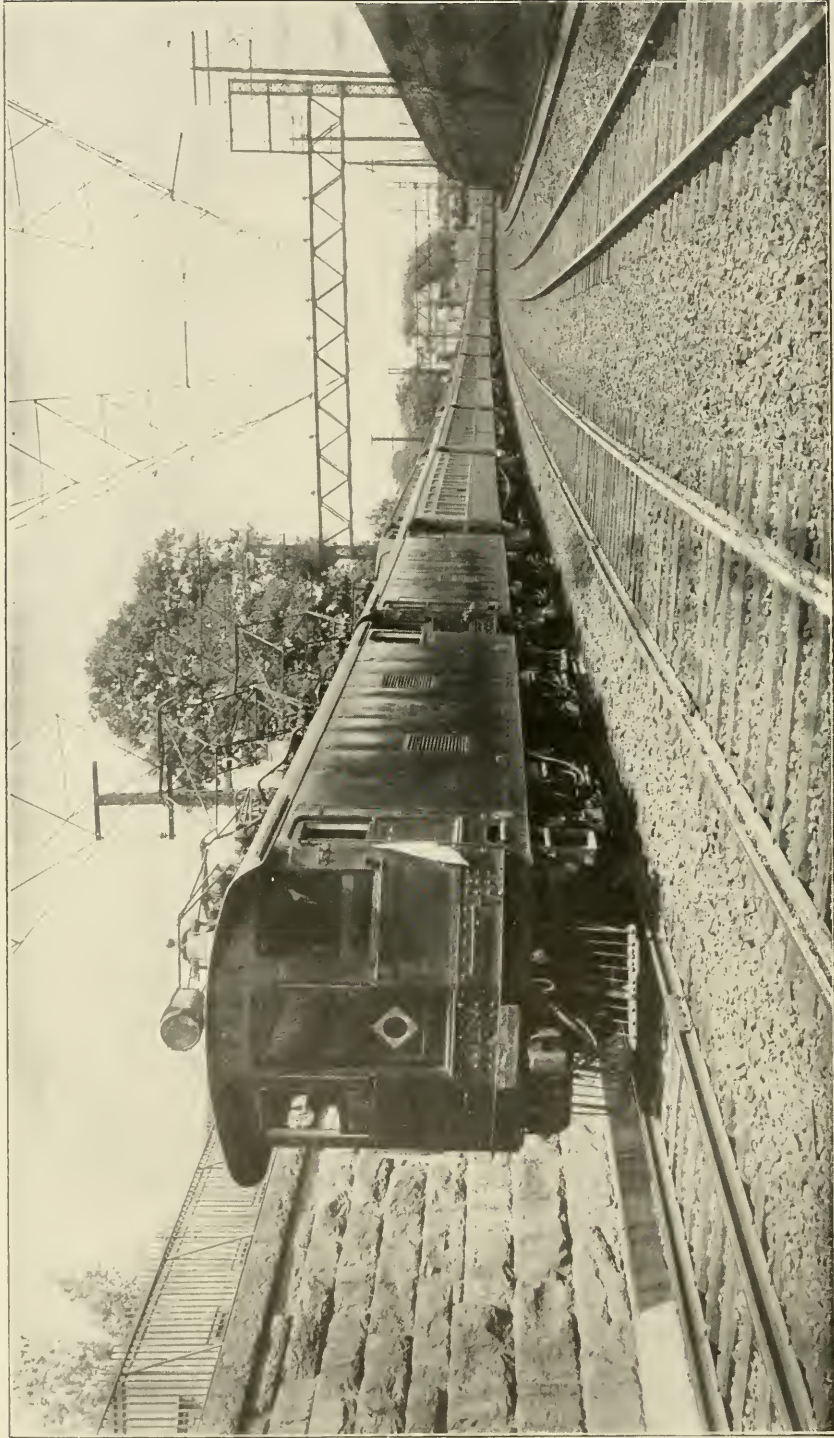

SINGLE-PHASE LOCOMOTIVES HAULING FAST PASSENGER TRAIN ON THE NEW YORK, NEW HAVEN, AND HARTFORD RAILWAY
Note the Line Construction.
Westinghouse Electric & Manufacturing Co., Pittsburg, Penna.

Foreword

ONE of the simplest acts in modern life is switching on the electric current that gives light or power, or that makes possible communication between distant points. A child can perform that act as effectively as a man, so thoroughly has electricity been broken to the harness of the world's work; but behind that simple act stand a hundred years of struggle and achievement, and the untiring labors of thousands of the century's greatest scientists. To compact the results of these labors into the compass of a practical reference work is the achievement that has been attempted—and it is believed accomplished—in this latest edition of the Cyclopedia of Applied Electricity.

Books on electrical topics are almost as many as the subjects of which they treat, and all of them, if gathered into a great common library, would contain so many duplicate pages that their use would entail an appalling waste of time upon the man who is trying to keep up with electrical progress. To overcome this difficulty the publishers of this Cyclopedia went direct to the original sources, and secured as writers of the various sections, men of wide practical experience and thorough technical training, each an acknowledged authority in his work; and these contributions have been correlated by our Board of Editors into a logical and unified whole.

The Cyclopedia is, therefore, a complete and practical working treatise on the generation and application of electric power.

It covers the known principles and laws of Electricity, its generation by dynamos operated by steam, gas, and water power; its transmission and storage; and its commercial application for purposes of power, light, transportation, and communication. It includes the construction as well as the operation of all plants and instruments involved in its use; and it is exhaustive in its treatment of operating "troubles" and their remedies.

¶ The Cyclopedia is as thoroughly scientific as any work could be; but its treatment is as free as possible from abstruse mathematics and unnecessary technical phrasing, while it gives particular attention to the careful explanation of involved but necessary formulas. Diagrams, curves, and practical examples are used wherever they may be helpful in explaining the subject under discussion.

¶ The Cyclopedia is a compilation of many of the most valuable Instruction Books of the American School of Correspondence, and the method adopted in its preparation has been found to be the best devised for the education of the busy, practical man.

¶ A glossary of the electrical terms used in this Cyclopedia will be found in Volume VII. The definitions are given in simple language and, where it was thought desirable, reference has been made to the volume and page where the reader may find added matter on the topic sought.

¶ Attention is directed to a bibliography of the best literature in Electrical Engineering, in Volume VII. No attempt has been made to exhaust the sources but merely to provide the names, authors, and publishers of books which would appeal to the widest circle of readers.

¶ In conclusion, grateful acknowledgment is due to the staff of authors and collaborators, without whose hearty co-operation this work would have been impossible.

Table of Contents

VOLUME V

POWER TRANSMISSION *By George C. Shaad* † Page *11

Conductors—Materials—Resistance—Current-Carrying Capacity—Insulation—Distribution Systems—Three-Wire System—Alternating-Current Systems—Voltage Regulation—Polyphase Systems—Transmission Lines—Capacity—Inductance—Alternating-Current Lines—Calculations—Transformers—Power Losses—Efficiency—Regulation—Connections—Frequency—Overhead Lines—Location—Poles—Cross-Arms—Insulators—Line Stresses—Conductors—Underground Construction—Conduit Materials—Manholes—Cables—Selection of Voltage—Line Production

ELECTRIC RAILWAYS *By Henry H. Norris* Page 97

Engineering Features—Rolling Stock and Equipment—Car Construction—Trucks—Journal Boxes and Bearings—Wheels—Gears—Direct-Current Series Motors—Construction—Field and Armature—Commutator—Brushes and Brush Holders—Bearings—Gearing—Other Types of Motor—Operating Characteristics—Alternating-Current Motors—Manual Controller—Multiple-Unit Controller—Sprague-General Electric Control—Cut-Out Switch—Circuit Breaker—Master Controller—Westinghouse Unit Switch Control—Air Supply—Automotoneer—Current Limit Relay—General Electric 1200-Volt Equipment—Brakes and Braking—Air Brakes—Pump Governor—Brake Cylinder—Operating Valve—Safety Valve—Westinghouse Automatic Friction Brake—Stopping a Car—Car Equipment—Trolley—Heaters—Lighting System—Car Wiring System—Equipment of Cars—Circuit Breakers, Fuses, and Lightning Arresters—Canopy Switch—Mechanics of Car Movements—Curve and Grade Resistance—Acceleration—Braking—Coasting—Maintenance of Rolling Stock—Inspection—Locating Faults—Testing—Burn-Outs—Defects in Armature Winding—Sparking at the Commutator—Failure of Car to Start—Power Plants—Construction and Arrangement—Modern Railway Plant—St. Clair Tunnel Power Plant—Electrical Details of Power Plant—Direct-Current Machines—Railway Switchboards—Cost Details of Power Plants—Load Factor—Substations—Transmission—Poles and Towers—Insulators—Distributing System—Overhead Construction—Trolley and Fastenings—Span-Wire, Bracket, and Catenary Construction—Third-Rail Construction—Protection—Bonding—Bond Testing—Feeder Systems—Stray Currents—Electrolysis—Signal Systems—Dispatcher—Block Signals—Track Construction—Track Support—Underground Conduit System—Steam Railway Electrification—Direct-Current Locomotives—New York Central Locomotives—Pennsylvania Locomotive—Alternating-Current Single-Phase Locomotives—New Haven Gearless Locomotive—Grand Trunk Locomotive—Alternating-Current Polyphase Traction Motors—Great Northern Locomotive—Distribution of Power for Heavy Traction

TRACKLESS TROLLEY TRACTION *By J. P. Schroeter* Page 381

Unique Features and Advantages: Railless, Light Weight, Roadways, Mobility, Current Consumption—Schiemann System—Mercedes-Stoll System—Kochler System—English Railless System—Filovia System—American Installations

SELF-PROPELLED RAILWAY CARS *By Hugo Diemer* Page 403

Motor Velocipedes—Inspection Motor Cars—Section Motor Cars—Gasoline Locomotives for Industrial Railways—Single- and Double-Track Cars—Combination Gasoline-Electric Railway Cars—Railway Coaches with Steam Power

REVIEW QUESTIONS Page 425

INDEX Page 433

* For page numbers, see foot of pages.

† For professional standing of authors, see list of Authors and Collaborators at front of volume.

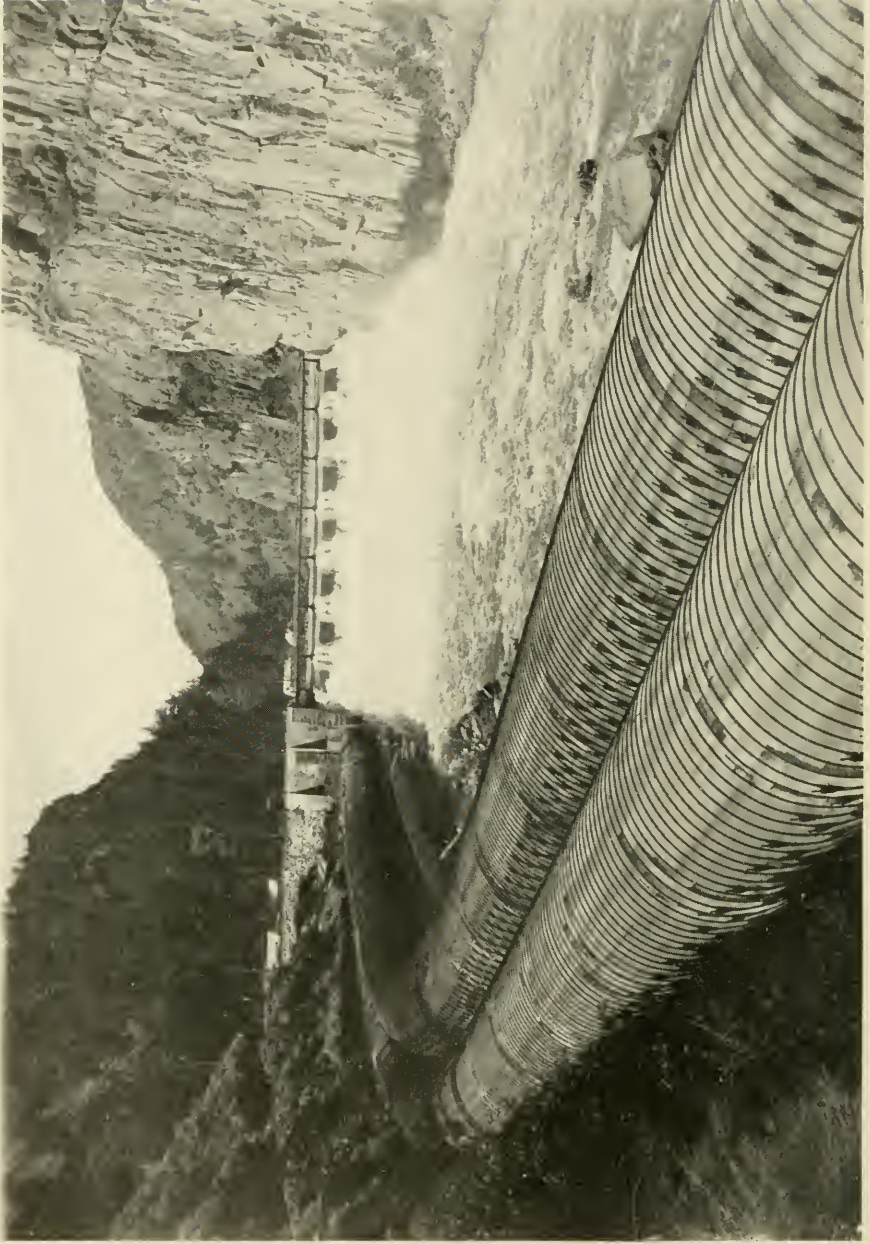

MADISON DAM, ROCK FILL TIMBER CREEK AND PIPE LINES

The dam is 44 feet high and 183 feet long. The wood stave pipes are 10 and 12 feet in diameter, respectively, and are 7500 feet long.

Courtesy of Montana Power Company

POWER TRANSMISSION

INTRODUCTION

The subject of electrical power transmission is a very broad one as it deals with the transmission and distribution of electrical energy, as generated by the dynamo or alternating-current generator, to the receivers. The receivers may be lamps, motors, electrolytic cells, etc. Electrical distribution of power is better than other systems on account of its superior flexibility, efficiency, and effectiveness; and we find it taking the place of other methods in all but a few applications. For some purposes the problem is comparatively simple, while for other purposes, such as supplying a large system of incandescent lamps scattered over a comparatively large area, it is quite complicated. As with other branches of electrical engineering, it is only in recent years that any great advances have been made in the means employed for the transmission of electrical power, and while this advance has been very rapid, there is still a large field for development.

In a study of this subject, the different methods employed and their application, the most efficient systems to be installed for given service, the preparation of conductors and the calculation of their size, together with the proper installation of the same, should be considered.

CONDUCTORS

Material. Power, in any appreciable amount, is transmitted electrically by the aid of metal wires, cables, tubes, or bars. The materials used are iron or steel, copper, and aluminum; of these three, the two latter are the most important, iron or steel being used to a considerable extent only in the construction of telephone and telegraph lines, and even here they are rapidly giving way to copper. Steel may be used in some special cases, such as extremely long spans in overhead construction or for the working conductors for railway installations using a third rail. Phosphor bronze has a limited use on account of its mechanical strength.

TABLE I
Copper Wire Table

DIMENSIONS			RESISTANCE		
A. W. G. or B. & S.	DIAMETER	AREA	OHMS PER FOOT		
	Inches	Circular Mils	At 20° C.	At 50° C.	At 80° C.
0000	.460	211,600	.00004893	.00005467	.00006058
000	.4096	167,800	.00006170	.00006893	.00007640
00	.3648	133,100	.00007780	.00008692	.00009633
0	.3249	105,500	.00009811	.0001096	.0001215
1	.2893	83,690	.0001237	.0001382	.0001532
2	.2576	66,370	.0001560	.0001743	.0001932
3	.2294	52,630	.0001967	.0002198	.0002435
4	.2043	41,740	.0002480	.0002771	.0003071
5	.1819	33,100	.0003128	.0003495	.0003873
6	.1620	26,250	.0003944	.0004406	.0004883
7	.1443	20,820	.0004973	.0005556	.0006158
8	.1285	16,510	.0006271	.0007007	.0007765
9	.1144	13,090	.0007908	.0008835	.0009791
10	.1019	10,380	.0009972	.001114	.001235
11	.09074	8,234	.001257	.001405	.001557
12	.08081	6,530	.001586	.001771	.001963
13	.07196	5,178	.001999	.002234	.002476
14	.06408	4,107	.002521	.002817	.003122
15	.05707	3,257	.003179	.003552	.003936
16	.05082	2,583	.004009	.004479	.004964
17	.04526	2,048	.005055	.005648	.006259
18	.04030	1,624	.006374	.007122	.007892

Copper and aluminum are used in the commercially pure state and are selected on account of their conductivity and comparatively low cost. The use of aluminum is at present limited to long-distance transmission lines or to large bus bars, and is selected on account of its being much lighter than copper. It is not used for insulated conductors because of its comparatively large cross-section and consequent increase in amount of insulation necessary. Other metals may serve to conduct electricity but they are not applied to the general transmission of energy.

Weight. The specific gravity of copper is 8.89. The value for aluminum is 2.7, showing that aluminum weighs .483 times as

much as copper for the same conductivity or resistance. It is this property which makes its use desirable in special cases. Iron, as used for conductors, has a specific gravity of 7.8.

Mechanical Strength. Soft-drawn copper has a tensile strength of 25,000 to 35,000 pounds per square inch. Hard-drawn copper has a tensile strength of 50,000 to 70,000 pounds per square inch, depending on the size; the lower value corresponding to Nos. 0000 and 000.

Aluminum has a tensile strength of about 33,000 pounds per square inch for hard-drawn wire $\frac{1}{4}$ inch in diameter. For transmission purposes aluminum is used in the form of cable.

Resistance. The resistance of electrical conductors is expressed by the formula

$$R = \frac{l}{A} f$$

where R is total resistance of the conductors considered; l is length of the conductors in the units chosen; A is area of the conductors in the units chosen; and f is a constant depending on the material used and on the units selected.

For cylindrical conductors, l is usually expressed in feet and A in circular mils. By a circular mil is meant the area of a circle .001 inch in diameter. A square mil is the area of a square whose sides measure .001 inch and is equivalent to 1.27 circular mils. Cylindrical conductors are designated by gauge number or by their diameter. The Brown & Sharpe (B. & S.) or American wire gauge is used almost universally and the diameters corresponding to the different gauge numbers are given in Table I. Wires above No. 0000 are designated by their diameter or by their area in circular mils.

A convenient way of determining the size of a conductor from its gauge number is to remember that a No. 10 wire has a diameter of nearly one-tenth of an inch and the cross-section is doubled for every three sizes larger—Nos. 7, 4, etc.—and one-half as great for every three sizes smaller—Nos. 13, 16, etc. 1,000 feet of No. 10 copper wire has a resistance of 1 ohm and weighs 31.4 pounds.

When f is expressed in terms of the mil foot, a wire 1 foot in length having a cross-section of 1 mil, its value for copper of a purity

POWER TRANSMISSION

TABLE II
Resistances of Pure Aluminum Wire

A. W. G. or B. & S.	RESISTANCE AT 75° F.	
	Ohms per 1,000 feet	Ohms per mile
0000	.08177	.43172
000	.10310	.54440
00	.13001	.68645
0	.16385	.86515
1	.20672	1.09150
2	.26077	1.37637
3	.32872	1.7357
4	.41448	2.1885
5	.52268	2.7597
6	.65910	3.4802
7	.83110	4.3885
8	1.06802	5.5355
9	1.32135	6.9767
10	1.66667	8.8000
11	2.1012	11.0947
12	2.6497	13.9900
13	3.3412	17.642
14	4.3180	22.800
15	5.1917	27.462
16	6.6985	35.368
17	8.4472	44.602
18	10.6518	56.242

known as Matthiessen's Standard, or copper of 100 per cent conductivity, is 9.586 at 0° C.* For 99.5 per cent pure aluminum its value is given as 15.2. Table II gives the resistance of aluminum wire. This shows that the conductivity of aluminum is about 63 per cent of that of copper. The conductivity of iron wire is about $\frac{1}{2}$ that of copper.

Matthiessen's standard is based on the resistance of copper supposed, by Matthiessen, to be pure. Since his experiments, improvements in the refining of copper have made it possible to produce copper of a conductivity exceeding 100 per cent. Copper of a conductivity lower than 98 per cent is seldom used for power-transmission purposes.

*The commercial values given for the mil foot vary from 10.7 to 11 ohms.

TABLE III
Temperature Coefficients for Copper

INT. TEMP. IN DEGREES C.	TEMP. COEFFICIENT PER DEGREE C.	INT. TEMP. IN DEGREES C.	TEMP. COEFFICIENT PER DEGREE C.
0	.0042	26	.003786
1	.004182	27	.003772
2	.004165	28	.003758
3	.004148	29	.003744
4	.004131	30	.003730
5	.004114	31	.003716
6	.004097	32	.003702
7	.004080	33	.003689
8	.004063	34	.003675
9	.004047	35	.003662
10	.004031	36	.003648
11	.004015	37	.003635
12	.003999	38	.003622
13	.003983	39	.003609
14	.003967	40	.003596
15	.003951	41	.003583
16	.003936	42	.003570
17	.003920	43	.003557
18	.003905	44	.003545
19	.003890	45	.003532
20	.003875	46	.003520
21	.003860	47	.003508
22	.003845	48	.003495
23	.003830	49	.003483
24	.003815	50	.003471
25	.003801		

Temperature Coefficient. The specific resistance—resistance per mil foot—is given for copper as 9.586 at 0° C. Its resistance increases with the temperature according to the approximate formula

$$R_t = R_0 (1 + at)$$

where R_t is resistance at temperature t° C.; R_0 is resistance at 0° C.; and a is the temperature coefficient, equal to .0042 for copper, commercial value.

The value of a for aluminum does not differ greatly from this. It is usually taken as .0039.

TABLE IV
Safe Carrying Capacity of Wires

A. W. G. OR B. & S.	RUBBER INSULATION	OTHER INSULATIONS
	Amperes	Amperes
18	3	5
16	6	8
14	12	16
12	17	23
10	24	32
8	33	46
6	46	65
5	54	77
4	65	92
3	76	110
2	90	131
1	107	156
0	127	185
00	150	220
000	177	262
0000	210	312
Circular Mils		
200,000	200	300
300,000	270	400
400,000	330	500
500,000	390	590
600,000	450	680
700,000	500	760
800,000	550	840
900,000	600	920
1,000,000	650	1,000
1,100,000	690	1,080
1,200,000	730	1,150
1,300,000	770	1,220
1,400,000	810	1,290
1,500,000	850	1,360
1,600,000	890	1,430
1,700,000	930	1,490
1,800,000	970	1,550
1,900,000	1,010	1,610
2,000,000	1,050	1,670

The temperature coefficient for copper at temperature other than 0°C. is given by the Standardization Report of the A. I. E. E. in Table III. Knowing the resistance of a coil of wire at, say 25° C. (R_{25}), in order to find its resistance at a temperature rise of 10° above 25 we have the formula

$$R_{.5+10} = R_{25} (1 + 0.003801 \times 10)$$

In order to find the temperature rise in degrees centigrade from an initial resistance R_i at a temperature i° C. and a final resistance of R_{i+r} , we may use the formula

$$r = (238.1 + i) \left[\frac{R_{i+r}}{R_i} - 1 \right]$$

when r = rise in degrees centigrade.

Effects of Resistance. The effect of resistance in conductors is threefold.

- (1) There is a drop in voltage, determined from Ohm's law,

$$I = \frac{E}{R}, \text{ or } E = IR$$

- (2) There is a loss of energy proportional to the resistance and the square of the current flowing. Loss in watts = $I^2 R = \frac{E^2}{R}$

- (3) There is a heating of the conductors, due to the energy lost, and the amount of heating allowable depends on the material surrounding the conductors. The drop in voltage or the heating limit is usually more important in the design of a transmission system than the loss of energy.

Current-Carrying Capacity. The temperature of a conductor will rise until heat is lost at a rate equal to the rate it is generated, so that a conductor is capable of carrying only a certain current with a given allowable temperature rise. The limit of this rise in temperature is determined by fire risk or injury to insulation. A general rule is that *the current density should not exceed 1,000 amperes per square inch of cross-section for copper conductors.* This value is too low for small wire and too high for heavy conductors, and it is governed by the way in which the conductors are installed. This value serves for bus bars where the thickness of the copper used is limited to $\frac{1}{4}$ inch. Curves shown in Figs. 1 and 2 are applicable to switchboard wiring, and Table IV gives the safe carrying capacity of conductors for inside wiring. Perrine, in Table V, shows the class of conductors to be used under various conditions.

Insulation. Insulation, in the form of a covering, is required for electrical conductors in all cases with the exception of switch-board bus bars and connections and wires used on pole lines, and

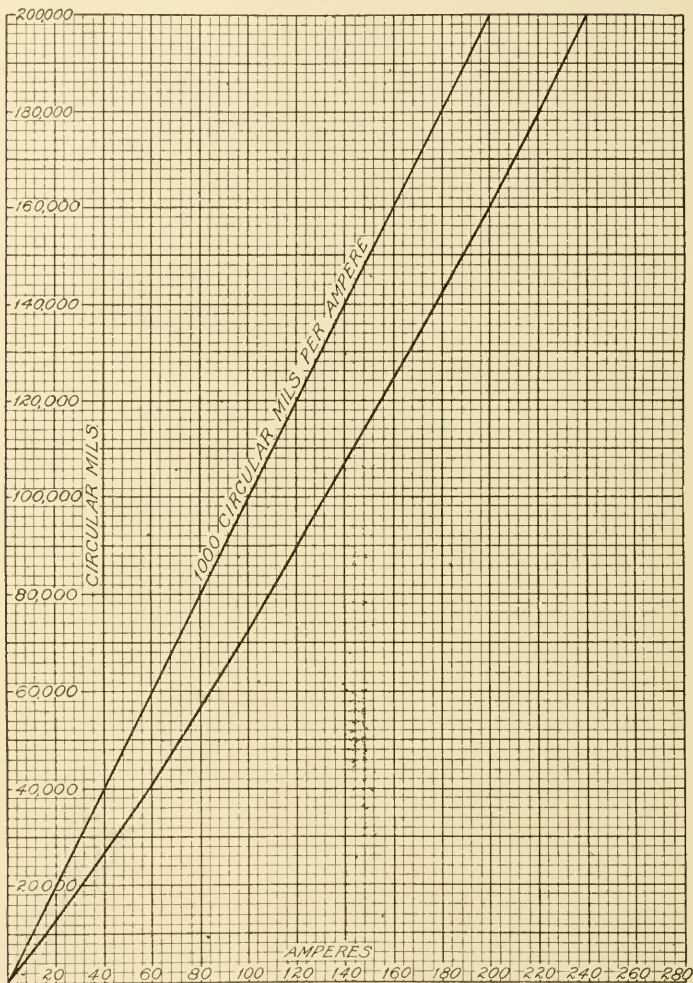

Fig. 1. Curves Showing Safe Carrying Capacity of Copper Wires

even these are often insulated. It may serve merely to keep the wires from making contact, as is the case with cotton- or silk-covered wire. Again, the wire may be covered with a material having a high specific resistance but being weak mechanically, and this combined

with a material serving to give the necessary strength to the insulation. For this purpose yarns are used as the mechanical support, and waxes and asphaltum serve for the insulation proper.

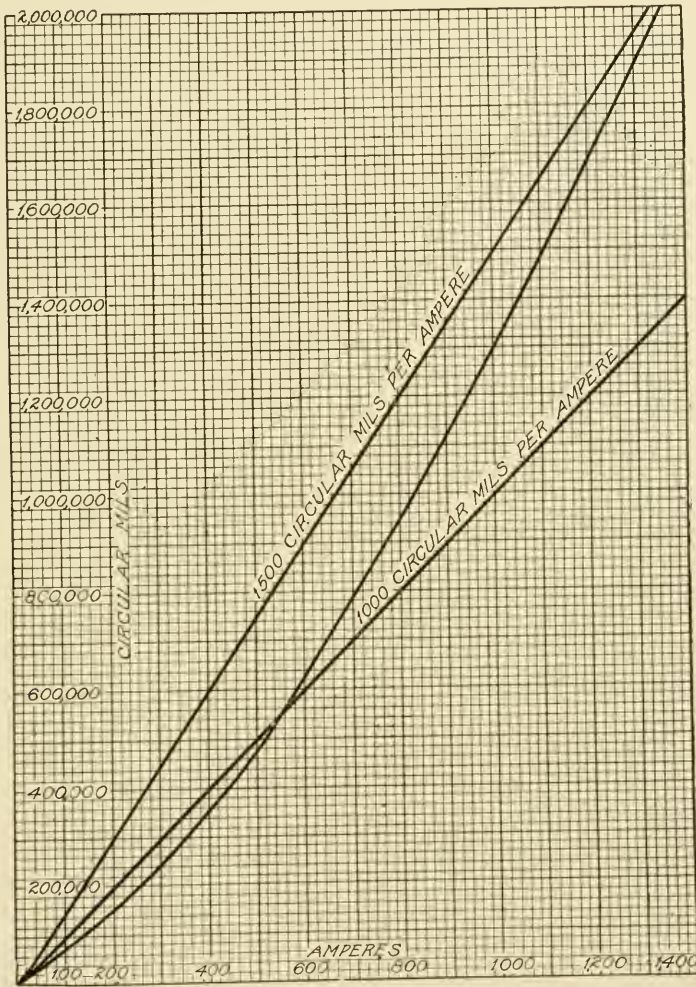

Fig. 2. Curves Showing Safe Carrying Capacity of Copper Wires

Annunciator wire is covered with heavy cotton yarn saturated with paraffin. The so-called *underwriter's wire* is insulated with cotton braid saturated with white paint. Asphaltum or mineral wax is used for insulating *weatherproof wire*. It may be applied in

TABLE V

PART I

Conductors for Various Conditions

Reference No.	Remarks	Reference No.	Remarks
1	Not allowed	8	In insulating tubes
2	Clear spaces	9	In wood moldings
3	Through trees	10	Without further precaution
4	On glass insulators	11	If necessary
5	On porcelain knobs	12	Below 350 volts
6	In porcelain cleats	13	Above 350 volts
7	In wood cleats		

PART II

Class of Conductors for Various Positions

DESCRIPTION OF CONDUCTOR	POSITION							
	Open air	Dry rooms	Damp rooms	Concealed under floor or wall	Rooms containing gases or vapor	Under water	Under-ground	
							Buried	In conduit
Bare wire.....	{ 2-4 3-1 }	1	1	1	1	1	1	2-4
Underwriter's insulation.....	1	{ 2-5 or 6 13-1 }	1	1	1	1	1	1
Double weatherproof.....	{ 12-4 13 & 2-4 }	{ 2-5 or 6 13-1 }	{ 12-4 13-1 }	1	1	1	1	1
Triple weatherproof.....	13-4	{ 13-5 or 6 or 8 }	{ 12-4 13-1 }	{ 12-8 13-1 }	{ 12-4 13-1 }	1	1	1
Plain rubber.....	{ 13-4 3-1 }	13-5	{ 12-5 13-4 }	13-8	{ 12-5 13-4 }	11	1	2-5
Taped or braided rubber.....	13-4	13-5	{ 12-5 13-4 }	13-8	{ 12-5 13-4 }	11	1	2-5
Taped or braided cored rubber.....	13-4	13-5 or 9	{ 12-5 13-4 }	13-8	{ 12-5 13-4 }	11	1	2-5
Gutta-percha, armored.....	1	1	1	1	1	10	1	1
Rubber, cased.....	10	9	1	8	1	11	11	11
Paper, cased.....	10	9	1	8	1	11	1	11
Fiber, leaded.....								
Any insulation, leaded and asphalted.....	10	9	6	8	6	11	11	10

several ways, the best insulation being made by covering the conductor with a single braiding laid over asphaltum and then passing the covered wire through the liquid insulation, at the same time applying two cotton braids, and finishing by an external application

of asphaltum and polishing. The most complete insulation is made up of a material which gives the most perfect insulation and which is strong enough, mechanically, to withstand pressure and abrasion without additional support.

Gutta-percha is used for submarine cables but *India rubber* is the insulating material most used for electrical conductors. Gutta-percha cannot be used when exposed to the air, as it deteriorates rapidly under such conditions. Rubber, when used, is vulcanized, and great care is necessary in the process. This vulcanized rubber is usually covered with braid having a polished asphaltum surface. The insulation of high-tension cables will be considered in the discussion of "Underground Construction".

DISTRIBUTION SYSTEMS

SINGLE CIRCUIT

Distribution systems may be divided into *series* systems and *parallel* systems, or combinations such as *series-parallel* or *parallel-series* systems. Various translating devices may be connected in circuit, changing from one system to the other, and the parallel system may be divided into *single-* and *multiple-circuit* systems commonly known as *two-wire* and *three-* or *five-wire* systems.

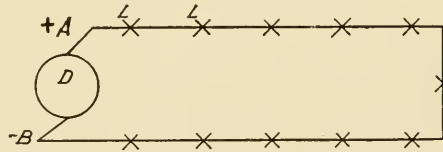

Fig. 3. Diagram of Series Distributing System

Series. Series systems are applied to series arc lighting, to series incandescent lighting, and to constant-current motors driving machinery or generators feeding secondary circuits. They serve for both alternating and direct currents. Fig. 3 shows the arrangement of units in this system. The current, generated by the dynamo *D*, passes from the positive brush *A*, in direct-current systems, through the units *L* in series to the negative brush *B*. For lighting purposes, this current has a constant value and special machines are used for its generation. The voltage at the generator depends on the voltage required by the units and on the number of units connected in service. As an example, the voltage allowed for a direct-current open-arc lamp and its connections may be taken as 50 volts.

If 40 lamps are burning, the potential generated will be $50 \times 40 = 2,000$ volts. The number of units is sometimes great enough to raise this potential to 6,000 volts; but by a special arrangement of the Brush arc machine, known as the *multiple-circuit arc machine*, the potential

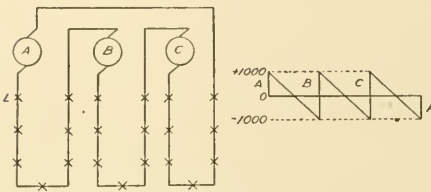

Fig. 4. Brush Multiple Circuit Arc Machine Connections

is so distributed that its maximum value on the line is but 2,000 volts, provided the lamps are equally distributed; while the total electromotive force generated is 6,000 volts when the machine is fully loaded.

The machine is supplied with three commutators and the lamps are connected as shown in Fig. 4, which also shows the distribution of potential.

All calculations for series systems are simple. The drop in voltage is obtained from Ohm's law, $I = \frac{E}{R}$. A wire smaller than No. 8 should never be used for line construction, as it would not be strong enough mechanically, even though the drop in voltage with its use should be well within the limit.

The current taken by arc lamps seldom exceeds 10 amperes. For series incandescent lighting, the current may be lower than this, having a value of from 2 to 4 amperes. Special devices are used to prevent the breaking of a single filament from putting out all of the lights in the system, and automatic short-circuiting devices are used with series arc lamps for accomplishing the same purpose.

As an example of the calculation of series circuits, it is required to find the drop in voltage and loss of energy in a line four miles long and composed of No. 8 wire, when the current flowing in the line is 9.6 amperes. From Table I we have a resistance of .0007007 ohm per foot for No. 8 wire at 50° C. This gives a resistance of 3.7 ohms per mile, or a resistance of 14.8 ohms for the circuit. From Ohm's law, the drop in voltage equals current times resistance, or equals $9.6 \times 14.8 = 142$ volts. The loss in energy equals the square of the current times the resistance, or equals $9.6^2 \times 14.8 = 1,364$ watts. If the circuit contains 80 lamps, each taking 50 volts, the total voltage

of the system is 4,142 volts, and the percentage drop in pressure is $\frac{142}{4142} = 3.43$ per cent

Parallel. In the parallel, or "multiple-arc," system of distribution, the lamps or motors are supplied with a constant potential, and the current supplied by the generators is the sum of the currents taken by each translating device. There are several methods of distribution applicable to this system, each one having some characteristic which makes its use desirable for certain installations. The usual arrangement is to run conductors, known as *feeders*, out from the station, and connected to these feeders are other conductors, known as *mains*, to which, in turn, the receivers or translating devices are connected. Fig. 5 is a diagram of such a "feeder and main" system.

The feeders may be connected at the same ends of the mains, known as *parallel feeding*; or they may be connected at the opposite ends of the main, giving us the *anti-parallel* system of feeding. The mains may be of uniform cross-section throughout, or they may change in size so as to keep the current density approximately constant. The above conditions give rise to four possible combinations, namely,

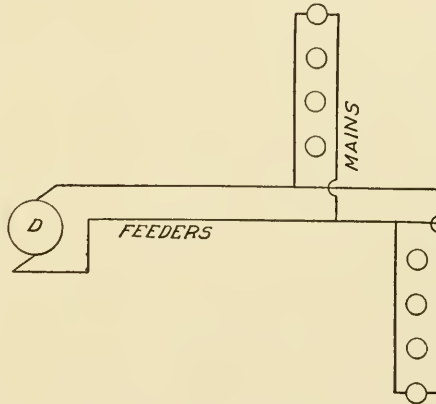

Fig. 5. Diagram of "Feeder and Main" System

- Case (1) Cylindrical conductors, parallel feeding, Fig. 6.
- Case (2) Tapering conductors, parallel feeding, Fig. 7.
- Case (3) Cylindrical conductors, anti-parallel feeding, Fig. 8.
- Case (4) Tapering conductors, anti-parallel feeding, Fig. 9.

The regulation of the voltage of a system is of particular importance when incandescent lamps are supplied; and the calculation of the drop in voltage to lamps connected to mains supplied with a constant potential should be considered. Without going into detail as to the methods of derivation, we have the following for-

mulas which apply to the above combinations when the receivers are uniformly distributed and each taking the same amount of current,

$$\text{Case (1)} \quad D = \frac{RIx}{l}(2l-x)$$

$$\text{Case (2)} \quad D = 2RIx$$

$$\text{Case (3)} \quad D = \frac{RIx}{l}(l-x)$$

$$\text{Case (4)} \quad D = 0$$

where D is the difference between potentials applied to different lamps; R is the resistance of conductors per unit length at feeding

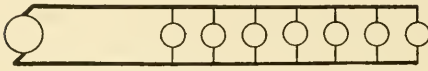

Fig. 6. Parallel Feeding System. Cylindrical Conductors

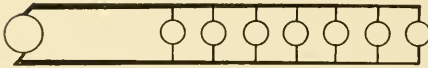

Fig. 7. Parallel-Feeding System. Tapering Conductors

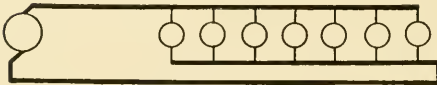

Fig. 8. Anti-Parallel System. Cylindrical Conductors

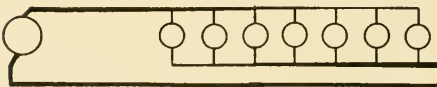

Fig. 9. Anti-Parallel System. Tapering Conductors

point. This will be a constant quantity for cylindrical conductors, but will change for tapering conductors, having its minimum value at the feeding point, and its maximum value at the end of the main. I is the current in the main at the feeding point, or point at which the feeders are connected to the mains. In Figs. 6, 7, 8, and 9 the mains only are shown in detail. x is the distance from the feeding point to the particular lamps at which the voltage is being considered; and l is the length of the main.

For Cases (1) and (2), the maximum difference of potential is found where $x=l$, that is, at the lamps located at the end of the mains.

For Case (3), the maximum difference of potential is found where $x = \frac{l}{2}$, or at the lamp located at the middle point of the mains.

For Case (4), the potential on all of the lamps is the same, but the difference between the voltage on the feeders and the voltage on the lamps is equal to RIl .

For unequal distribution of receivers and special feeding points, the drop in voltage can be calculated by the aid of Ohm's law, but this calculation becomes quite complicated for extensive systems. It usually is sufficient to keep the *maximum* drop within the desired limits when designing electrical conductors for lighting, being careful not to exceed the safe carrying capacity of the wires.

The drop in voltage on the feeders may be calculated directly from Ohm's law when direct current is used, knowing the current flowing and the dimensions of the conductors used.

Additional formulas are given in "Electric Wiring," which will aid in determining the size of wire to be used for a given installation.

As examples of calculation we have the following:

System consists of 20 lamps, each taking .5 amperes. $l=80$ feet. $R=.01$ ohm per foot at feeding point. Find the maximum difference of potential on the lamps in each of the first three cases.

$$I = 20 \times .5 = 10 \text{ amperes}$$

$$\text{Case (1)} \quad D = \frac{.01 \times 10 \times 80}{80} \times (160 - 80) = 8 \text{ volts}$$

$$\text{Case (2)} \quad D = 2 \times .01 \times 10 \times 80 = 16 \text{ volts}$$

$$\text{Case (3)} \quad D = \frac{.01 \times 10 \times \frac{80}{2}}{80} \times \left(80 - \frac{80}{2}\right) = 2 \text{ volts}$$

In Case (4), the difference in potential applied to the lamps and the potential of the feeders would be $.01 \times 10 \times 80 = 8$ volts.

Again, with the maximum allowable drop given, the resistance of the wires at the feeding point may be determined. For tapering conductors, the current density is kept approximately constant by using wire of a smaller diameter as the current decreases. Thus supposing, as in the case considered, that the resistance at the feeding point was .01 ohm per foot. At a distance of 40 feet from the feeding point the current would be only $\frac{1}{2}$ of 10, or 5 amperes, and the size of the wire would be one-half as great, giving it a resistance at this point of .02 ohm per foot.

Feeding Point. In order to determine the point at which a system of mains should preferably be fed, that is, the point where

the feeders are attached to the mains, it is necessary to find the electrical center of gravity of the system. The method employed is similar to that used in determining the best location of a power plant as regards amount of copper required, and consists of separately obtaining the center of gravity of straight sections and then determining the total resultant and point of application of this resultant of the straight sections to locate the best point for feeding. Actual conditions are often such that the system cannot be

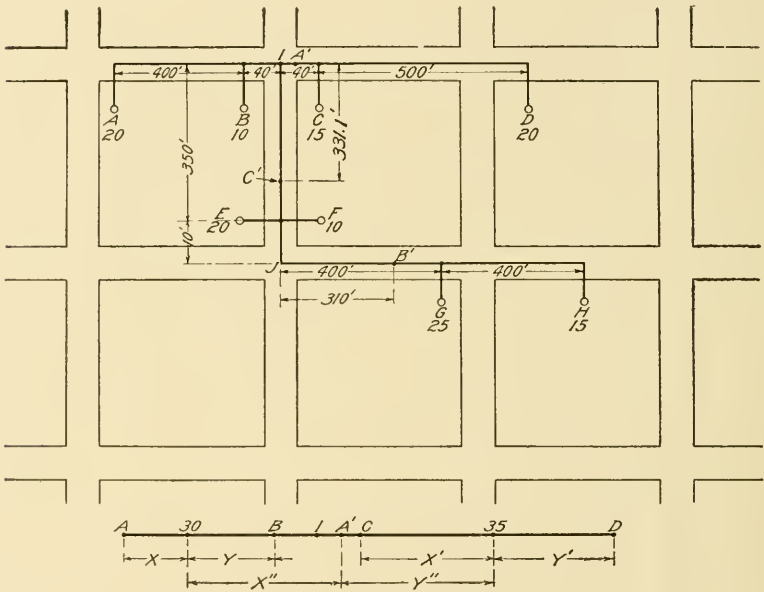

Fig. 10. Diagram to Determine Feeding Point

fed at a point so determined, but it is well to run the feeders as close to this point as is practical, as less copper is then required for a given drop in potential.

Consider, as an example, a system such as is shown in Fig. 10. The number of lamps and location of the same are shown in this figure. The loads A , B , C , D , may be considered as concentrated at A' , a point 33.8 feet from I and equal to $A+B+C+D$. This point is obtained as follows:



VIEW OF THE BOISE HYDRO-ELECTRIC POWER PLANT AT BOISE, IDAHO
The plant develops 2000 horsepower which is transmitted about twelve miles up the River to Arrowrock Dam site where it is used for construction purposes

$$\begin{array}{rcl}
 Ax = By & 10y = 20x & x + y = 400 \\
 A + B = 30 & & x = 133.3 \text{ feet.} \\
 Cx' = Dy' & 15x' = 20y' & x' + y' = 500 \\
 & & x' = 285.7 \text{ feet.} \\
 & C + D = 35 & \\
 (A + B)x'' = (C + D)y'' & & x'' + y'' = 632.4 \\
 30x'' = 35y'' & & x'' = 340.5 \text{ feet.} \\
 & A + B + C + D = 65 & \\
 & A' \text{ is } 6.2 \text{ feet from } C \text{ or } 33.8 \text{ feet from } I. &
 \end{array}$$

E and *F* may be combined to form a group of 30 lamps and the resultant of *E*, *F*, *G*, and *H* is 70 lamps located at *B'*, a point 310 feet from *J*, this point being located in the same manner as *A'*. Similarly, we find the resultant of the loads at *A'* and *B'* to be 135 lamps located at *C'*, a point 331.1 feet from *I*, and the proper feeding point for the system.

$$\begin{array}{l}
 A' = 65 \text{ lights, } 33.8 \text{ feet from } I \\
 B' = 70 \text{ lights, } 310 \text{ feet from } J \\
 \text{Distance } IJ = 360 \text{ feet} \\
 \text{Distance from } A' \text{ to } B' = 360 + 310 + 33.8 = 703.8 \text{ feet} \\
 65x = 70y \\
 x + y = 703.8 \text{ feet} \\
 x = 364.9 \text{ feet} \\
 364.9 - 33.8 = 331.1 \text{ feet}
 \end{array}$$

Feeding at a point 331.1 feet from *I*, the main should be connected to the point *A* in order for the potential drop from the feeding point to be the same to the points *A*, *D*, and *H*, and 33.8 feet of extra main would be required. If no change in the mains is to be made, then the system may be resolved into a linear system by starting at the branch on which the drop of potential will be a maximum, the branch leading to *D* in the above problem, and considering the other branches as if they were concentrated loads applied at the points where the branches are taken off. Thus, loads *A* and *B* are added and considered as a load of 30 amperes applied at *I*, and loads *E* and *F* are combined and considered as a load of 30 amperes applied at a point 350 feet from *I*. We then have a linear system consisting of loads as follows: 20 amperes at the end *D*, 15 amperes 500 feet from *C*, 30 amperes 540 feet from *D* at *I*, 30 amperes 890 feet

from D , 25 amperes 1,300 feet from D at G , and 15 amperes 1,700 feet from D at H . The feeding point is then found from the equation giving the distance to the center of gravity (uniform size or conductor assumed):

$$\begin{aligned} \text{Distance from } D \text{ to best} &= \frac{20 \times 0 + 15 \times 500 + 30 \times 540 + 30 \times 890}{20 + 15 + 30 + 30 + 25 + 15} = \\ \text{feeding point in feet} &= \frac{108400}{135} = 803 \end{aligned}$$

Distance from I to best feeding point = $803 - 540 = 263$ feet.

The above is a simple definite case. Should the load be variable, the proper feeding point will change with the load, and, in extensive systems, the location of this point can be obtained approximately only. The same method of calculation is employed in locating the points from which sub-feeders are run out from the terminals of the main feeders as is the case in large systems, the voltage being maintained constant at the point where the sub-feeders are connected to the feeders.

Good practice shows the drop in potential to be within the following limits:

From feeding points (points where sub-feeders or mains are attached) to lamps.....	5	per cent
Loss in sub-feeders.....	3	per cent
Loss in mains.....	1.5	per cent
Loss in service wires.....	0.5	per cent

The actual variation of voltage should not exceed 3 per cent.

Series-Multiple and Multiple-Series. In the series-multiple and the multiple-series systems, groups of units, connected in multiple, are arranged in series in the circuit, or groups of units are connected in series and those, in turn, connected in multiple, respectively. The application of such systems is limited. They are used to some extent in street-lighting when incandescent lamps are used.

MULTIPLE CIRCUIT

Three-Wire. We have seen that in any system of conductors the power lost is equal to I^2R . For a given amount of power transmitted, IE , the current varies inversely with the voltage and con-

sequently the amount of power lost, which is directly proportional to the square of the current, is inversely proportional to the square of the voltage. Hence, for the same loss of power and the same percentage drop in voltage, doubling the voltage of the system would allow the resistance of the conductors to be made four times as great, and wire of one-fourth the cross-section or one-fourth the amount of copper would be required.

The voltage for which incandescent lamps, having a reasonable efficiency, can be economically manufactured is limited to 220, while the majority

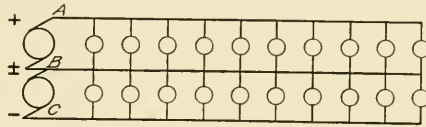

Fig. 11. Diagram of 3-Wire Lighting System

of them are made for 110. In order to increase the voltage on the system, a special connection of such lamps is necessary. The three-wire and five-wire systems are adopted for the purpose of increasing this voltage. Fig. 11 shows a diagram of a three-wire system. Consider the conductor *B* removed and we have a series-multiple system with two lamps in series. This arrangement does not give independent control of individual lamps, and the third wire is introduced to take care of any unbalancing of the number of lamps or units connected on either side of the system, and to allow more freedom in the location of the lights. The current flowing in the conductor *B*, known as the *neutral conductor*, depends on the difference of the currents required by the units on the two sides of the system. Fig. 12 shows a system in which the loads on the two sides are unequal, an unbalanced system, with the value of the current in the neutral wire at different points.

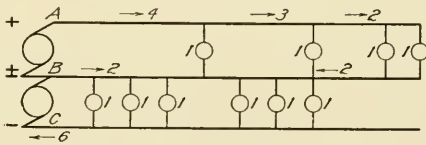

Fig. 12. Diagram of 3-Wire System—Unbalanced Load

Each unit is here assumed to take one ampere.

As stated above, were no neutral wire required, the amount of copper necessary for a system with the lamps connected, two in series, for the same percentage drop in voltage would be one-fourth the amount necessary for the parallel connection. This may be shown as follows: The current in the wire in the first case is one-half as great, so that the voltage drop would be divided by two for

the same size wire. The voltage on the system is twice as great, so that, with the same percentage regulation, the actual voltage drop would be doubled. Consequently wire of one-fourth the cross-section and weight may be used. If the neutral wire is made one-half the size of the outside conductor, as is usually the case in feeders, the amount of copper required is $\frac{5}{8}$ of that necessary for the two-wire system. For mains it is customary to make all three conductors the same size, increasing the amount of copper to $\frac{3}{2}$ of that required for a two-wire system. For a five-wire system with all conductors the same size, the weight of copper necessary is .156 times that for a two-wire system.

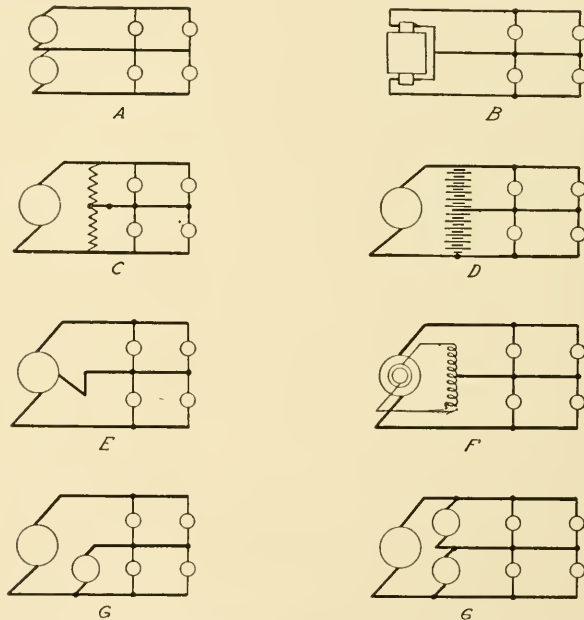

Fig. 13. Diagrams of 3-Wire Generating Methods

Multiple-wire systems have no advantage other than a saving of copper, except when used for multiple-voltage systems, while among their disadvantages may be mentioned:

- Complication of generating apparatus
- Complication of instruments and wiring
- Liability to variation in voltage, due to unbalancing of load

Generating Methods. Fig. 13 shows some of the methods employed in generating current for a three-wire system.

- (A) Two dynamos connected in series.
- (B) A double dynamo.
- (C) Bridge arrangement, using a resistance with the neutral connection arranged so as to change the value of resistance in either side of the system. Has the disadvantage of continuous loss of energy in the resistance.
- (D) Storage battery connected across the line with neutral connected at middle point.
- (E) Special dynamo supplied with three brushes.
- (F) Special machine having collector rings, across which is connected an impedance coil, the neutral wire being connected to the middle point of this coil.
- (G) Compensators or motor-generator set used in connection with generator. The motor-generator set is known as a *balancer set*.

Storage batteries are not installed primarily for furnishing voltage for a three-wire system, but when installed primarily for other purposes, they may be used for the three-wire distribution.

Another type of three-wire dynamo is equipped with balancing coils placed on the armature and a collector ring and neutral brush added, thus doing away with the impedance coil of F but adding to the armature winding.

Three-wire dynamos or compensators are at present used in preference to the other systems illustrated.

Compensators are usually wound for about 10 per cent of the capacity of the machine with which they are used. A 10-kilowatt balancer set will take care of a load on the neutral, which, at the voltage of one side of the system, would give a total of 10 kilowatts. In the motor-generator set, one side becomes a motor or generator depending on whether the load on that side is less or greater than the load on the opposite side.

Voltage Regulation. It is customary to keep the voltage on the mains constant, or as nearly so as possible, at the point where the feeders are attached. Where but one set of feeders is run out from the station, this may readily be accomplished by the use of over-compounded dynamos, adjusted to give an increase of voltage equal to the drop in the feeders at different loads. Again, the field of a shunt-wound generator may be controlled by hand, the pressure at the feeding points being indicated by a voltmeter connected to pilot wires running from the feeding point back to the station.

When the system is more extensive, separate regulation of different feeders is necessary. A variable resistance may be placed in series with separate feeders, but this is undesirable on account of a constant loss of energy. Feeders may be connected in along a system of mains and one or more of these switched in or out of service as the load changes. Bus bars giving different voltages may be arranged so that the feeders can be changed to a higher voltage bar as the load increases. Boosters—series dynamos—may be connected in series with separate feeders and these may be arranged to regulate the voltage automatically. The use of boosters is not to be recommended except for a few very long feeders, and then the total capacity of boosters should equal but a small percentage of the station output if the efficiency of the system as a

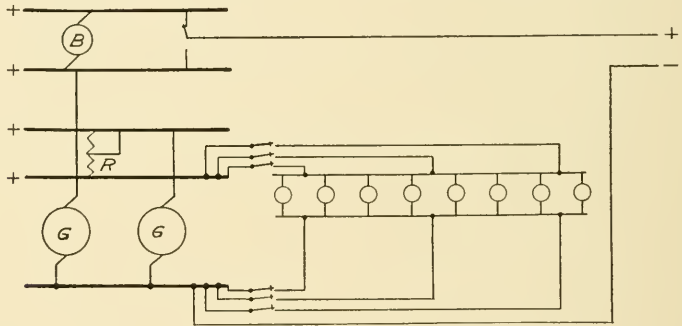

Fig. 11. Diagram of Connections for Voltage Regulation

whole is to remain high. Fig. 14 is a diagram of a system using different methods of voltage regulation.

ALTERNATING CURRENT

Alternating-current systems of distribution may be classified in a manner similar to direct-current systems, that is, as series and parallel systems; but in addition to these we have a classification depending on the number of phases used, such as single-phase, quarter- or two-phase, and three-phase systems.

Series. The series system may consist of a simple series circuit fed by a constant-current generator, or it may be fed by a constant-current transformer, the primary of which is supplied with a constant potential, the secondary furnishing a constant current. For

a description of such a transformer, see "Electric Lighting." Again, the current may be maintained constant by means of a constant-current regulator, such as is described in "Electric Lighting". Constant-current alternators are seldom used, the two latter forms of regulation being applied to most series installations. The principal application of series alternating-current systems is to street-lighting. Parallel-series alternating-current systems are sometimes used for street-lighting with incandescent lamps.

Parallel. Parallel systems using alternating current are also analogous to parallel systems using direct current, though the receivers, especially if lamps, are seldom connected directly to the leads coming from the station, but are fed from the secondaries of constant-potential transformers, which are connected to the lines in parallel, and step down the voltage. The readiness with which the voltage of such systems may be changed by means of suitable transformers is the chief advantage of the single-phase systems. The voltage may be generated at, or transformed up to, a high value at the station, transmitted a considerable distance over small conductors with little loss of energy, and then transformed to the desired value for the connected units. Transformers may readily be constructed to furnish voltage for a three-wire secondary distribution. Fig. 15 is a diagram of a single-phase system supplying power to both two-wire and three-wire systems. Two separate transformers are used for obtaining the three-wire system, in one case, and a transformer, supplied with a tap connected to the middle point of the secondary, is used in the other case.

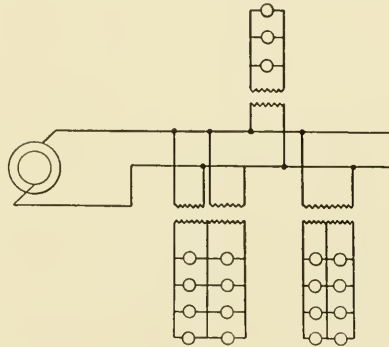

Fig. 15. Single-Phase System with Secondary 3-Wire System

Two separate transformers are used for obtaining the three-wire system, in one case, and a transformer, supplied with a tap connected to the middle point of the secondary, is used in the other case.

Voltage Regulation. The regulation of voltage for alternating-current systems may be accomplished, as in direct-current installations, by means of compounding ("composite-wound alternators"), hand regulation, or resistance or reactance connected in series with the feeders. In addition, the feeders may be controlled by means

of special regulators, such as the Stillwell regulator, or the "C R" regulator, which consist of transformers with the primary coil connected across the line and the secondary in series with the line, and so arranged that the number of turns in one or both windings may be varied; other forms of regulators are the magnetic regulator and the induction regulator.

For the automatic control of generator voltage, the composite-wound alternator has been discarded and the Tirrill regulator sub-

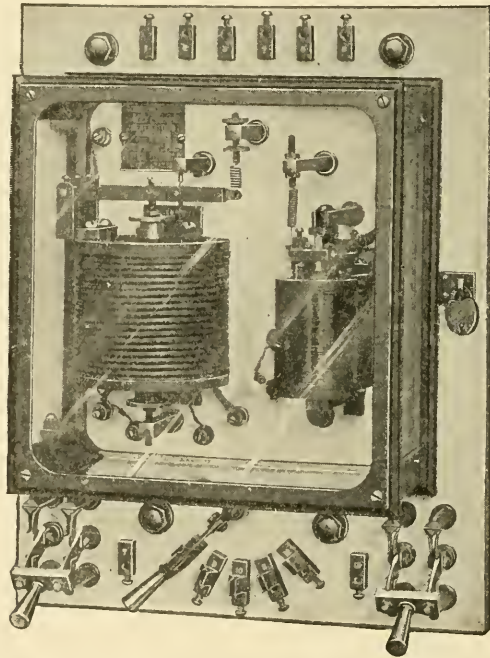

Fig. 16. Tirrill Regulator for Operating Directly on Generator Field

stituted. The Tirrill regulator is used for the voltage control of either direct- or alternating-current machines and maintains a steady potential at the bus bars, irrespective of the nature or the amount of the load. In the case of either the alternating-current system or the direct-current machines, the regulator may be adjusted so as to automatically raise the bus-bar potential as the load is increased, thus holding a steady voltage at some point out on the line; or it may be used to hold the voltage steady at the bus bars.

For small direct-current machines, the regulator operates directly upon the field of the generator, but for larger machines of the direct-current type or for alternators the regulator acts upon the field of a separate exciter. The general appearance of the Tirrill regulator for operating directly on the shunt field of a dynamo is shown in Fig. 16, and the diagram for the elementary connections is shown in Fig. 17. Referring to Fig. 17, the operation may be explained as follows: The field rheostat is adjusted until the generator gives about 65 per cent of normal potential on open circuit, in which case, when the regulator is put into operation, the potential winding of the main control magnet is excited below normal, and the main contacts are closed. With the main contacts closed, both windings of the relay magnet are excited and the relay contacts are closed on account of the fact that the relay magnet is differentially

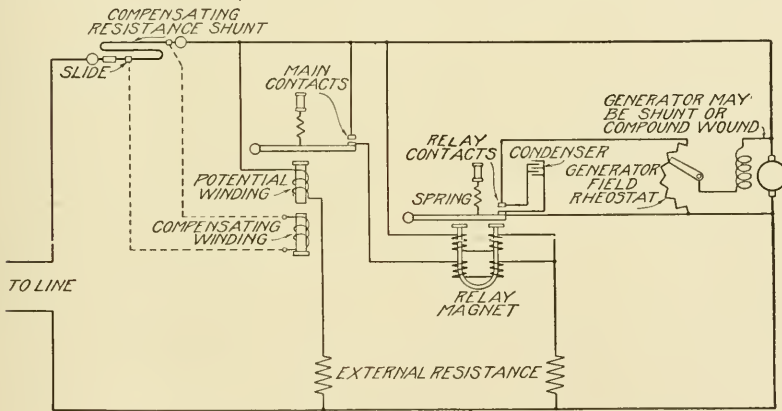

Fig. 17. Diagram for Tirrill Regulator Operating on Generator Field

wound. When the relay contacts are closed, the field rheostat is cut out of circuit and the generator voltage builds up. Any tendency to go above the voltage for which the regulator is adjusted allows the main contacts and the relay contacts to open, thus inserting the field resistance. In operation the main and relay contacts are in a continuous state of vibration and a steady voltage is maintained at the bus bars. In case the compensating winding is used, a steady voltage is maintained at the bus bars, but its value will be determined by the adjustment of the compensating winding and the value of the load.

A regulator designed to operate on the field of a separate exciter is shown in Fig. 18, and its operation may be explained by reference to Fig. 19. The field rheostat of the exciter is adjusted until the alternator gives 65 per cent of its normal voltage on open circuit.

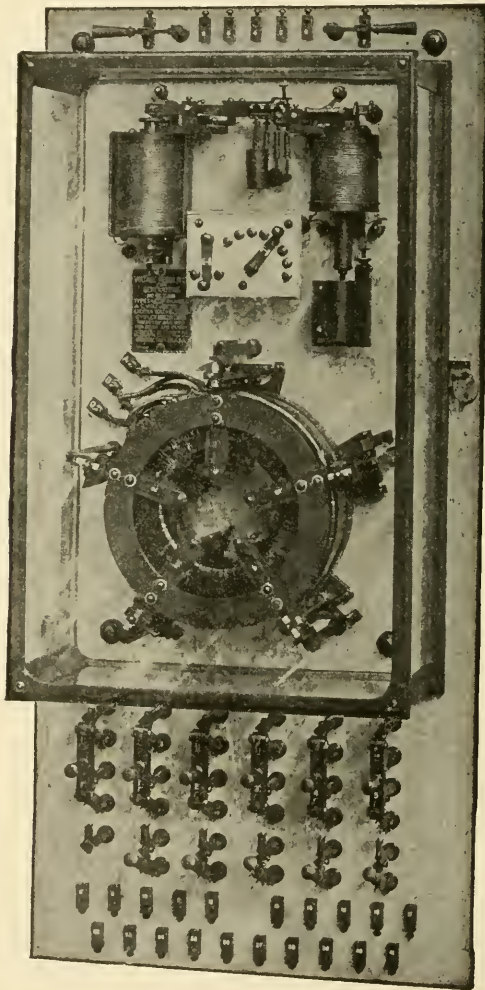

Fig. 18. Form of Tirrill Regulator Operating on Field of Exciter

The direct-current control magnet and the potential winding of the magnet connected to the secondary of the potential transformer are both under-excited and the floating main contacts are closed.

This closes the circuit through the second winding of the relay magnet and the relay contacts are closed, thus short-circuiting the field rheostat in the exciter field and raising the potential of the exciter and the alternator. The contacts are in constant vibration and a steady and constant potential is maintained at the bus bars in case the compensating winding is not in use. When the compensating winding is connected in, the potential at the bus bars remains steady but its value depends upon the adjustment of the regulator and the value of the load. The condenser shown in these diagrams is for the purpose of preventing excessive sparking at the contacts.

Polyphase. Polyphase systems of distribution are used where motors are to be run from the circuits; also for long-distance transmission lines, partly on account of the saving in copper. Polyphase

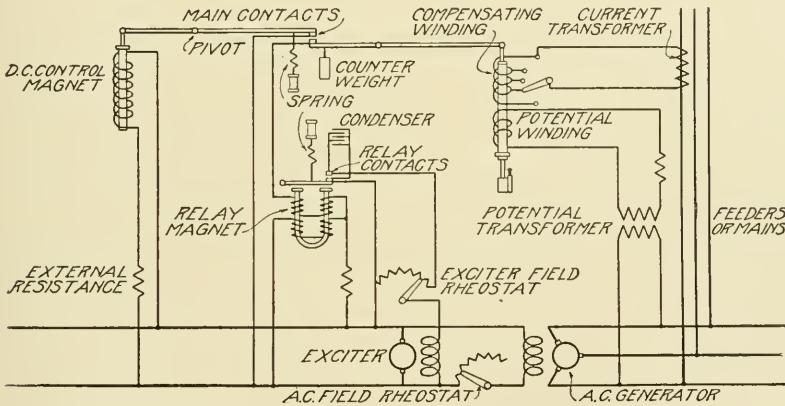

Fig. 19. Diagram of Tirrill Regulator Operating on Field of Exciter

generators may be constructed more cheaply, for a given output, than single-phase machines because of a better utilization of the winding space on the armature; while single-phase motors, except in small sizes, or series motors as applied to railway work, are not entirely satisfactory. The large majority of machines installed at the present time for either power or lighting are of the polyphase type. Two-phase and three-phase systems are the only ones that are in common use for power transmission, three phases being used for long-distance transmission lines. Six phases are used for rotary converters only, the capacity of the machines being greatly increased when connected six-phase.

Amount of Copper for Different Systems. The amount of copper required for the different systems, assuming the weight of copper for a single-phase two-wire system to be 100 per cent, is as follows:

Single-phase two-wire systems.....	100	per cent
Single-phase three-wire systems (Neutral wire same size as outside wires).....	37.5	per cent
Two-phase four-wire system.....	100	per cent
Two-phase three-wire system.....	72.9	per cent
Three-phase three-wire system.....	75	per cent
Three-phase four-wire system.....	33.3	per cent

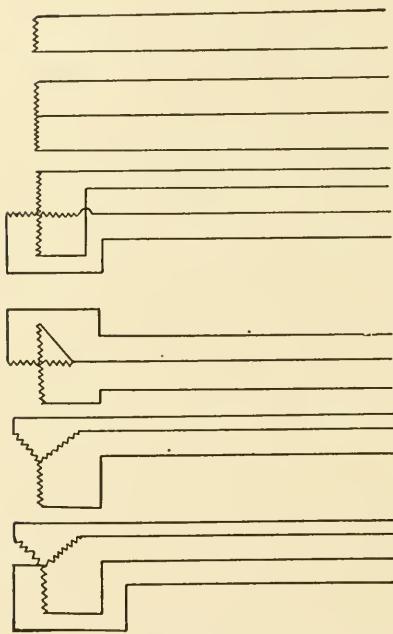

Fig. 20. Diagrams of Principal Wiring Systems

This assumes the voltage on the receivers to be the same in every case, the maximum voltage having different values, depending on the system used. The three-phase three-wire system is preferable to the two-phase three-wire system for most purposes on account of better voltage regulation. In the three-phase four-wire system the maximum voltage is $\sqrt{3}$ times the voltage on the receivers. Were the same maximum voltage allowable as in the three-phase three-wire system, the amount of copper for the three-phase four-wire system would be $\frac{1}{3}$ that required for the three-phase three-wire system. Fig. 20 shows, diagrammatically, the connections of the different systems.

In the three-phase four-wire system, single-phase loads are connected between the outside wires and the neutral, the neutral being the conductor leading to the common connection of the three phases.

As an example of the way in which the relative amounts of copper are calculated, take the three-phase three-wire system. Assume the amount of power transmitted to be P and the percentage loss of energy to be p . Let E be the voltage on the receiver,

I be the current flowing in a single conductor, single-phase system, and I' be the current in a single conductor, three-phase system. We have for the single-phase two-wire system

$$P = IE$$

and for the three-phase three-wire system

$$\begin{aligned} P &= \sqrt{3} I' E \\ IE &= \sqrt{3} I' E \\ I' &= \frac{I}{\sqrt{3}} \end{aligned}$$

The loss in energy in the two-wire system $= pP = 2 I^2 R$, when R is the resistance of one conductor. The loss in energy in the three-phase system $= pP = 3 I'^2 R'$, when R' is the resistance of a single conductor in the three-phase system.

Substituting $\frac{I}{\sqrt{3}}$ for I' , we have

$$2 I^2 R = \frac{3 I^2 R'}{3}, \text{ or } 2 R = R'$$

The amount of copper is inversely proportional to the resistance of the conductor, so that if W is the weight of one conductor for a single-phase system and W' is the weight of one conductor for a three-phase system

$$W = 2 W'$$

Two conductors are required in the first case $= 2 W$.

Three conductors are required in the second case $= 3 W'$.

$$\begin{aligned} 3 W' &= \frac{3}{2} W \\ 2 W &= 2 W \\ \frac{3 W'}{2 W} &= \frac{\frac{3}{2} W}{2 W} = \frac{3}{4} = 75 \text{ per cent} \end{aligned}$$

TRANSMISSION LINES

Capacity. Conductors, used for the transmission of power, together with their metallic shields, the ground, and neighboring conductors, form condensers, which, when the line is long, have an appreciable capacity. The capacity of circuits is quite readily calculated, the following formula applying to individual cases.

Case (1)—Insulated cable with lead sheath.

$$C = \frac{38.83 k 10^{-3}}{\log \frac{D}{d}} \text{ per mile}$$

Case (2)—Single conductor with earth return.

$$C = \frac{38.83 \times 10^{-3}}{\log \frac{4h}{d}} \text{ per mile}$$

Case (3)—Parallel conductors forming a metallic circuit.

$$C = \frac{19.42 \times 10^{-3}}{\log \frac{2A}{d}} \text{ per mile of circuit}$$

where C is capacity in microfarads; k is specific inductive capacity of insulating material; 1 for air; 2.25 to 3.7 for rubber; D is inside diameter of lead sheath; d is diameter of conductor; h is distance of conductors above ground; and A is distance between wires.

Common logarithms apply to these formulas and for a metallic circuit, C is the capacity between wires.

If the capacity be taken between one wire and the neutral point of a system, or the point of zero potential, the capacity is given as

$$C \text{ (in microfarads)} = \frac{.0776}{2 \log \frac{2A}{d}} \text{ per mile of circuit}^*$$

Table VI gives the capacity, to the neutral point, of different size wire used for three-phase transmission lines.

The effect of this capacity is to cause a charging current, 90 degrees in advance of the impressed pressure, to flow in the circuit, and the regulation of the system is affected by this charging current as will be seen later. Capacity may be reduced by increasing the distance between conductors or in lead-sheathed cables, by using insulation of low specific inductive capacity, such as paper.

Inductance. *Self-Inductance.* The self-inductance of lines is very readily calculated. The following formula is applicable to

*A mile of circuit includes two miles of conductor in a single-phase system and three miles of conductor in a three-phase system.

TABLE VI

Capacity in Microfarads per Mile of Circuit for Three-Phase System

SIZE B. & S.	DIAMETER IN INCHES	DISTANCE IN INCHES	CAPACITY C IN MICRO- FARADS	SIZE B. & S.	DIAMETER IN INCHES	DISTANCE IN INCHES	CAPACITY C IN MICRO- FARADS
0000	.46	12	.0226	4	.204	12	.01874
		18	.0204			18	.01726
		24	.01922			24	.01636
		48	.01674			48	.01452
000	.41	12	.0218	5	.182	12	.01830
		18	.01992			18	.01690
		24	.01876			24	.01602
		48	.01638			48	.01426
00	.365	12	.0124	6	.162	12	.01788
		18	.01946			18	.01654
		24	.01832			24	.01560
		48	.01604			48	.0140
0	.325	12	.02078	7	.144	12	.01746
		18	.01898			18	.01618
		24	.01642			24	.01538
		48	.01570			48	.01374
1	.289	12	.02022	8	.128	12	.01708
		18	.01952			18	.01586
		24	.01748			24	.01508
		48	.0154			48	.01350
2	.258	12	.01972	9	.114	12	.01660
		18	.01818			18	.01552
		24	.01710			24	.01478
		48	.01510			48	.01326
3	.229	12	.01938	10	.102	12	.01636
		18	.01766			18	.01522
		24	.01672			24	.01452
		48	.01480			48	.01304

copper or aluminum conductors, three-phase system; per mile of circuit.

$$L = .000558 \left[2.303 \log \left(\frac{2A}{d} \right) + .25 \right]$$

where L is inductance of the loop of a three-phase circuit in henrys.

TABLE VII
Inductance per Mile of Three-Phase Circuit

SIZE B. & S.	DIAMETER IN INCHES	DISTANCE IN INCHES	SELF-IN- DUCTANCE L HENRYS	SIZE B. & S.	DIAMETER IN INCHES	DISTANCE IN INCHES	SELF-IN- DUCTANCE L HENRYS
0000	.46	12	.00234	4	.204	12	.00280
		18	.00256			18	.00300
		24	.00270			24	.00315
		48	.00312			48	.00358
000	.41	12	.00241	5	.182	12	.00286
		18	.00262			18	.00307
		24	.00277			24	.00323
		48	.00318			48	.00356
00	.365	12	.00248	6	.162	12	.00291
		18	.00269			18	.00313
		24	.00285			24	.00329
		48	.00330			48	.00369
0	.325	12	.00254	7	.144	12	.00298
		18	.00276			18	.00310
		24	.00293			24	.00336
		48	.00331			48	.00377
1	.289	12	.00260	8	.128	12	.00303
		18	.00281			18	.00325
		24	.00308			24	.00341
		48	.00338			48	.00384
2	.258	12	.00267	9	.114	12	.00310
		18	.00288			18	.00332
		24	.00304			24	.00348
		48	.00314			48	.00389
3	.229	12	.00274	10	.102	12	.00318
		18	.00294			18	.00340
		24	.00310			24	.00355
		48	.00351			48	.00396

In Tables VI and VII a mile of circuit refers to one mile of pole line.

For a single-phase line the inductance of a loop for a mile of line or circuit, two miles of wire, the formula is

$$L = .000644 \left[2.303 \log \frac{2A}{d} + .25 \right]$$

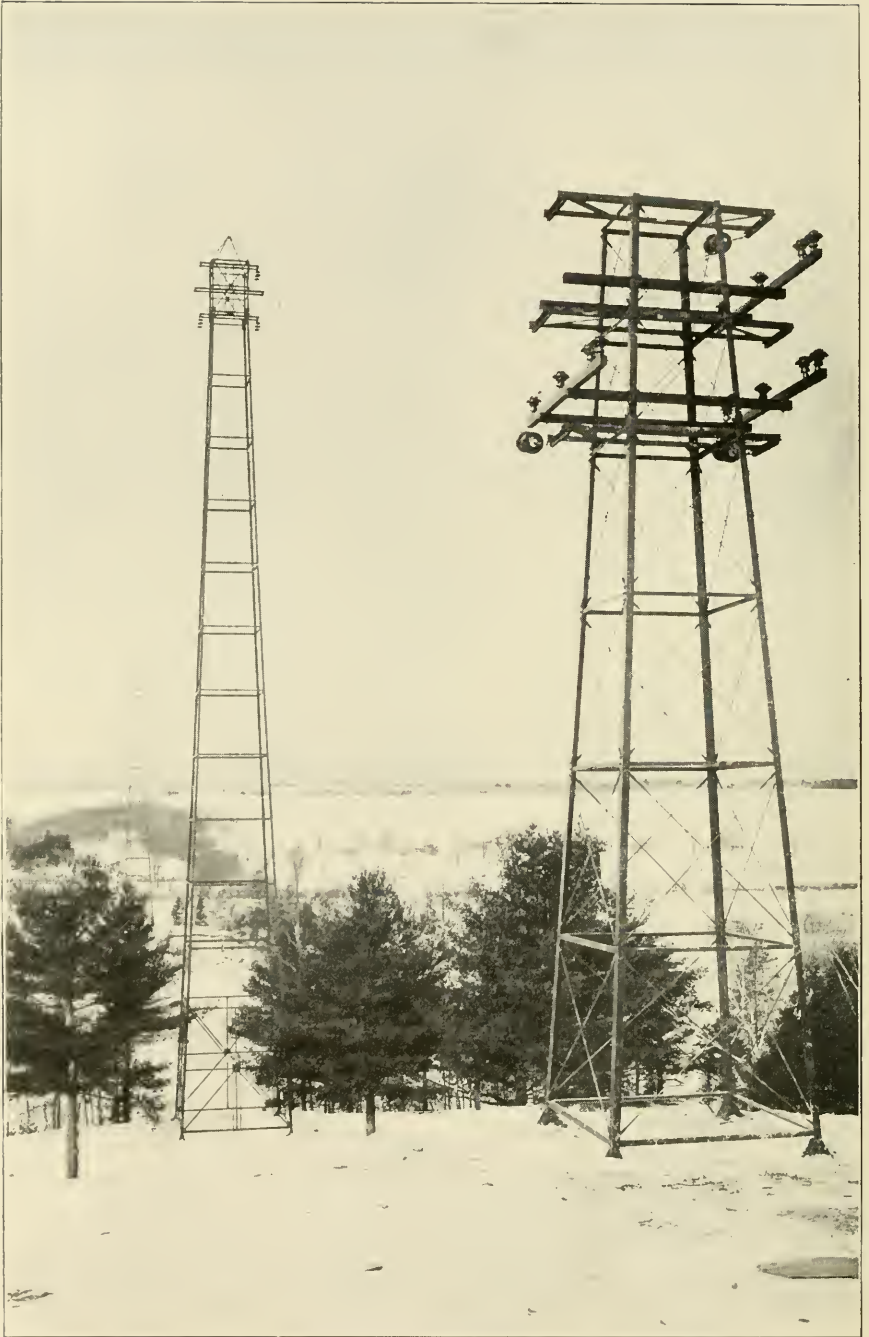

HIGH TENSION TRANSMISSION LINE CROSSING THE KENNEBEC RIVER
NEAR AUGUSTA, MAINE

Courtesy of Archbold-Brady Company

Where we use the "inductance of one wire" we have

$$L = .000322 \left[2.303 \log \frac{2A}{d} + .25 \right]$$

Table VII is based on the above formula for a three-phase line.

Self-inductance is reduced by decreasing the distance between wires and it disappears entirely in concentric conductors. Subdividing the conductors decreases the drop in voltage due to self-inductance but it complicates the wiring. Circuits formed of conductors twisted together have very little inductance. When alternating-current wires are run in iron pipes, both wires of the circuit must be run in the same pipe, inasmuch as the self-inductance depends on the number of magnetic lines of force passing between the conductors or threading the circuit, and this number will be increased when iron is present between the conductors.

The effect of self-inductance in a circuit is to cause the current to lag behind the impressed voltage and it also increases the impedance of the circuit.

The effect of self-inductance may be neutralized by capacity or *vice-versâ*. The relative value of the two for complete neutralization must be

$$C = \frac{1}{4(2\pi f)^2 L}$$

where C and L are in farads and henrys, respectively, and f is the frequency of the system.

Mutual-Inductance. By mutual-inductance is meant the inductive effect one circuit has on another separate circuit, generally a parallel circuit in power transmission. An alternating current flowing in one circuit sets up an electromotive force in a parallel circuit which is opposite in direction to the e. m. f. impressed on the first circuit, and is proportional to the number of the lines of force set up by the first circuit which thread the second circuit.

The effects of mutual-inductance may be reduced by increasing the distance between the circuits, the distance between wires of



Fig. 21. Section of Conductors Arranged to Reduce Mutual Inductance

a circuit remaining the same. This is impractical beyond a certain extent, if the circuits are to be run on the same pole line, so that a special arrangement of the conductors is necessary.

Figs. 21 and 22 show such special arrangements. In Fig. 21 AB forms the wires of one circuit and CD the wires of the other circuit. Lines of force set up by the circuit AB do not thread the circuit CD , provided $A, B, C,$ and D are arranged at the corners of a square so that there is no effect on the circuit CD . In Fig. 22 assume an e. m. f. to be set up in the portion of the circuit CD in the direction of the arrows. The e. m. f. in the section DE will

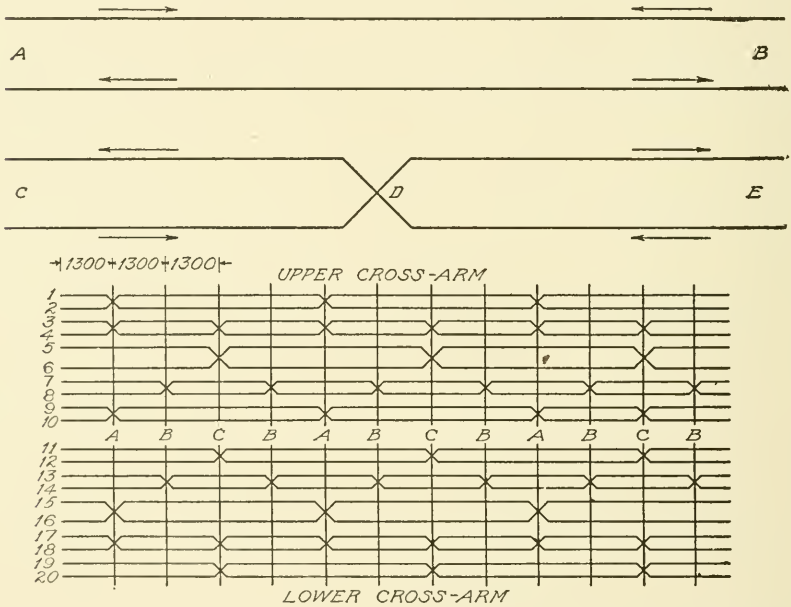

Fig. 22. Transposition Diagram of Ten Two-Wire Circuits to Reduce Mutual-Inductance

then be in the direction of the arrows shown and the effects on the circuit AB will be neutralized, provided the transposition, as the crossing of the conductors is called, is made at the middle of the line. Such transpositions are made at frequent intervals on transmission lines in order to do away with the effects of mutual-inductance which, at times, might be considerable. When several circuits are run on the same pole line, these transpositions must be made in such a manner that each circuit is transposed in its relation to

the other circuits. The transposition of the circuits of a line composed of ten two-wire circuits is shown in Fig. 22.

In the three-phase circuits, it is customary to transpose the three wires in order to do away with the effects of mutual-induction

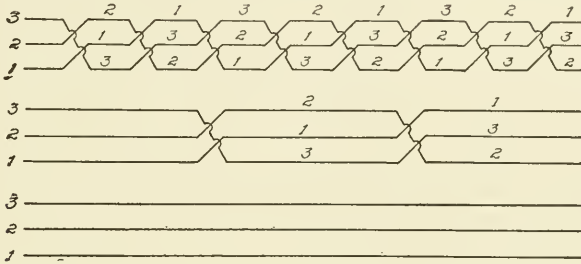

Fig. 23. Transposition Diagram of Three Parallel Three-Phase Lines to Reduce Mutual-Inductance

and in these transpositions the relative location of the wires is changed so as to bring each conductor the same average distance from every other parallel conductor. Fig. 23 shows the way in which the conductors of three parallel three-phase lines may be transposed so as to do away with disturbances due to mutual induction. The length of the straight section varies in practice from about one-half mile to five miles.

ALTERNATING-CURRENT LINES

Calculations. In dealing with alternating currents, Ohm's law can be applied only when all of the effects of inductance and capacity have been eliminated and, since this can seldom be accomplished, a new formula must be used which takes such capacity and inductance effects into account. Not only the inductance or capacity of the line itself must be considered, but the nature of the receiver must be taken into account as well, when the regulation of the system as a whole is being considered. The following quantities must be known in the complete solution of problems relating to alternating-current systems:

- (1) Frequency of the current used;
- (2) Self-induction and capacity of the receivers;
- (3) Self-induction and capacity of the lines;
- (4) Voltage of, and current flowing in, the lines;
- (5) Resistance of the various parts.

General Wiring Formulas. The following set of formulas, together with Table VIII, are used for calculating transmission lines proper when using direct or alternating current and for frequencies varying from 25 to 125, and for single and polyphase currents.

$$\text{Area of conductor, circular mils} = \frac{D \times W \times C'}{p \times E^2}$$

$$\text{Current in main conductors} = \frac{W \times T}{E}$$

where W is total watts delivered; D is distance of transmission (one way) in feet; p is loss in line in per cent of power delivered, that is, of W ; and E is voltage between main conductors at receiving or consumer's end of circuit.

For continuous current $C' = 2,160$, $T = 1$, $B = 1$, and $A = 6.04$.

$$\text{Volts loss in lines} = \frac{p \times E \times B}{100}$$

$$\text{Pounds copper} = \frac{D^2 \times W \times C' \times A}{p \times E^2 \times 1,000,000}$$

The following formula will be found convenient for calculating the copper required for long-distance three-phase transmission circuits:

$$\text{Pounds copper} = \frac{M^2 \times \text{kw.} \times 300,000,000}{p \times E^2}$$

where M is the distance of transmission in miles; kw. is the power delivered in kilowatts; and the power factor is assumed to be approximately 95 per cent.

Application of Formulas. The value of C' for any particular power factor is obtained by dividing 2,160—the value for continuous current—by the square of that power factor for single-phase, by twice the square of that power factor for three-wire three-phase, or four-wire two-phase.

The value of B depends on the size of wire, frequency, and power factor. It is equal to 1 for continuous current, and for alternating current with 100 per cent power factor and sizes of wire given in Table VIII.

NOTE—The figures given are for wires 18 inches apart, and are sufficiently accurate for all practical purposes provided the displacement in phase between current and e.m.f. at the receiving end is not very much greater than that at the generator; in other words, provided that the reactance of the line is not excessive or the line loss unusually high. For example, the constants should not be applied at 125 cycles if the largest conductors are used and the loss 20 per cent or more of the power delivered. At lower frequencies,

***TABLE VIII**
Data for Calculating Transmission Line Factors

SYSTEM	VALUES OF A					VALUES OF C'										VALUES OF T									
	VALUES OF A					VALUES OF B					VALUES OF B					VALUES OF B					VALUES OF B				
	Per Cent Power Factor					Per Cent Power Factor					Per Cent Power Factor					Per Cent Power Factor					Per Cent Power Factor				
No. of Wire & S. Gauge	Area of Wire Circular Mills	Weight of Bare Wire Per 1,000 ft.-lbs.	Resistance of Wire Per 1,000 feet at 25° C. Ohms	25 Cycles					40 Cycles					60 Cycles					125 Cycles						
				Per Cent Power Factor					Per Cent Power Factor					Per Cent Power Factor					Per Cent Power Factor						
				95	90	85	80	95	90	85	80	95	90	85	80	95	90	85	80	95	90	85	80		
0000	212000	641	.0499	1.23	1.29	1.33	1.34	1.52	1.53	1.61	1.67	1.62	1.84	1.99	2.09	2.35	2.86	3.24	3.49						
0000	168000	509	.0628	1.18	1.22	1.24	1.24	1.40	1.41	1.48	1.51	1.49	1.66	1.77	1.95	2.08	2.48	2.77	2.94						
00	133000	403	.0794	1.14	1.16	1.16	1.16	1.25	1.32	1.35	1.37	1.34	1.52	1.60	1.66	1.86	2.18	2.40	2.57						
0	106000	320	.0997	1.10	1.11	1.10	1.09	1.19	1.24	1.26	1.26	1.31	1.40	1.46	1.49	1.71	1.96	2.13	2.25						
1	83500	253	.126	1.07	1.07	1.05	1.03	1.14	1.17	1.18	1.17	1.24	1.30	1.34	1.36	1.56	1.75	1.88	1.97						
2	66600	202	.159	1.05	1.04	1.02	1.00	1.11	1.12	1.12	1.10	1.18	1.23	1.25	1.26	1.45	1.60	1.70	1.77						
3	52400	159	.202	1.03	1.02	1.00	1.00	1.07	1.08	1.07	1.05	1.14	1.17	1.18	1.17	1.35	1.46	1.53	1.57						
4	41600	126	.254	1.02	1.00	1.00	1.00	1.05	1.06	1.03	1.00	1.11	1.12	1.11	1.10	1.27	1.35	1.40	1.43						
5	33100	100	.319	1.00	1.00	1.00	1.00	1.03	1.01	1.00	1.00	1.08	1.08	1.06	1.04	1.21	1.27	1.30	1.31						
6	26200	79.5	.403	1.00	1.00	1.00	1.00	1.02	1.00	1.00	1.00	1.05	1.04	1.02	1.00	1.16	1.20	1.21	1.21						
7	20700	62.8	.510	1.00	1.00	1.00	1.00	1.01	1.00	1.00	1.00	1.03	1.02	1.00	1.00	1.12	1.14	1.14	1.13						
8	16600	50.4	.635	1.00	1.00	1.00	1.00	1.00	1.00	1.00	1.00	1.02	1.00	1.00	1.00	1.09	1.10	1.09	1.07						
9	13000	39.4	.813	1.00	1.00	1.00	1.00	1.00	1.00	1.00	1.00	1.00	1.00	1.00	1.00	1.06	1.06	1.04	1.02						
10	10400	31.5	1.01	1.00	1.00	1.00	1.00	1.00	1.00	1.00	1.00	1.00	1.00	1.00	1.00	1.04	1.03	1.00	1.00						

*Issued by General Electric Company.

however, the constants are reasonably correct even under such extreme conditions. They represent about the true values at 10 per cent line loss, are close enough at all losses less than 10 per cent, and often, at least for frequencies up to 40 cycles, close enough for even much larger losses. Where the conductors of a circuit are nearer each other than 18 inches, the volt loss will be less than given by the formulas, and if close together, as with multiple-conductor cable, the loss will be only that due to resistance.

The value of T depends on the system and power factor. It is equal to 1 for continuous current and for single-phase current of 100 per cent power factor.

The value of A and the weights of the wires in Table VIII are based on .00000302 pound as the weight of a foot of copper wire of one circular mil area.

NOTE.—In using the above formulas and constants, it should be particularly observed that p stands for the per cent loss in the line of the *delivered power*, not for the per cent loss in the line of the power at the generator; and that E is the potential at the delivery end of the line and not at the generator.

When the *power factor* cannot be more accurately determined, it may be assumed to be as follows for any alternating system operating under average conditions: Incandescent lighting and synchronous motors, 95 per cent; lighting and induction motors together, 85 per cent; induction motors alone, 80 per cent.

In *continuous-current three-wire systems*, the neutral wire for feeders should be made of one-third the section obtained by the formulas for either of the outside wires. In both continuous and alternating-current systems, the neutral conductor for secondary mains and house wiring should be taken as large as the other conductors.

The three wires of a *three-phase circuit* and the four wires of a *two-phase circuit* should all be made the same size, and each conductor should be of the cross-section given by the first formula.

Numerical examples of the application of Table VIII, as well as of other formulas, are given later. A better idea of the way in which the different quantities involved affect the regulation of an alternating-current line may be obtained from graphical representation or from formulas which are not so empirical. Before taking up other methods of calculation, however, let us consider the meaning of power factor.

By *power factor* we mean the cosine of the angle by which the current lags behind or leads the electromotive force producing that current. It is the factor by which the apparent watts—volts times amperes—must be multiplied to give true power. The formula for power in a single-phase circuit is

$$\text{Power} = IE \cos \theta$$

where θ is the lag or lead angle; and for three-phase circuits

$$\text{Power} = IE \cos \theta \sqrt{3}$$

where I is the current flowing in a single conductor.

For two-phase circuits, balanced load, this becomes

$$\text{Power} = 2 IE \cos \theta$$

and for six-phase circuits

$$\text{Power} = 2 \sqrt{3} IE \cos \theta$$

For single- and three-phase circuits E is the voltage between lines; for two-phase circuits it is the voltage across either phase; and for six-phase circuits it is the voltage across one phase of what corresponds to a three-phase connection. If voltage is taken from line to line in the six-phase system

$$\text{Power} = 6 EI \cos \theta$$

Considering the formula for single phase, we find that the current flowing in the line may be taken as made up of two components, one in phase with the voltage and one 90 degrees out of phase, lagging,

or leading, depending on conditions. In Fig. 24, let OE equal the impressed pressure and OC the current

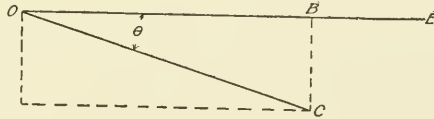

Fig. 24. Vector Diagram for Single-Phase System

flowing. θ is the angle of lag. The current OC may be resolved into two components, one in phase with $OE = OB$, and one 90 degrees behind $OE = BC$.

$$OB = OC \cos \theta$$

is known as the active component of the current.

$$BC = OC \sin \theta$$

is known as the wattless component of the current.

The capacity and inductance are distributed throughout the line, that is, the line may be considered as made up of tiny condensers and reactance coils, connected at short intervals as shown in Fig. 25. Considering the inductance and capacity as distributed in this manner, the regulation of a system may be calculated, but the process is very difficult, and simpler methods, which give very close results, have been adopted for practical work. Probably the

methods presented by Perrine and Baum are as simple as any except those based on purely empirical formulas.

Tables giving the capacity and inductance of lines, together with the formulas for the calculation of these quantities, have

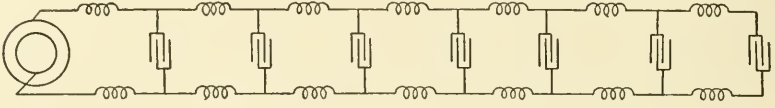

Fig. 25. Diagram of Distribution of Capacity and Inductance Throughout the Line

already been given. It has also been stated that the effect of the capacity of a line is to cause a charging current to flow in the line, this current being 90 degrees in advance of the impressed voltage. The value of this charging current is

$$\text{Charging current per wire} = \frac{E \times C \times 2\pi \times f}{2 \times 10^6}, \text{ single-phase}$$

where C is capacity in microfarads of one wire to neutral point; f is frequency of the circuit; and E is voltage between wires.

Charging current, three-phase, = $\frac{2}{\sqrt{3}}$, or $1.155 \times$ charging current, single-phase.

Since the voltage across the lines is not the same all along the line, the value of the charging current will not be the same, but the error introduced by assuming it to be constant is not great. For our calculation, then, we assume that the charging current in an open-circuited line is constant throughout its length, and also

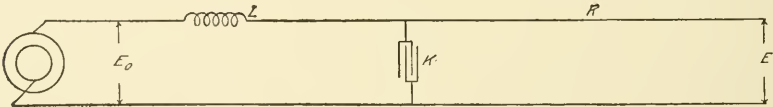

Fig. 26. Diagram of Single-Phase Line

that the capacity of the line may be taken as concentrated at the center of the line.

Consider a single-phase line such as is shown diagrammatically in Fig. 26. Let E_0 be the voltage at the generator end of the line; E , the voltage at the receiver; L , self-inductance of the line; I_0 , charging current per wire; I , current flowing in the line due to the load on the line; θ , angle by which the load current differs from

the impressed voltage; R , resistance of the line; e , drop in voltage in the line; ω , $2 \pi f$.

$+j$ is a symbol indicating that the current is 90 degrees in advance of the pressure.

$-j$ indicates that the current is 90 degrees behind the pressure.

The expression, $\sqrt{R^2+(2\pi fL)^2} = \sqrt{R^2+\omega^2 L^2}$ may be represented by $R+jL\omega$, the factor $+j$ indicating that the square root of the sum of the squares of these two quantities must be taken to obtain the numerical result. The quantity j^2 may be considered as -1 .

Taking the capacity of the line and considering it as a condenser located at the middle of the line, we may assume the charg-

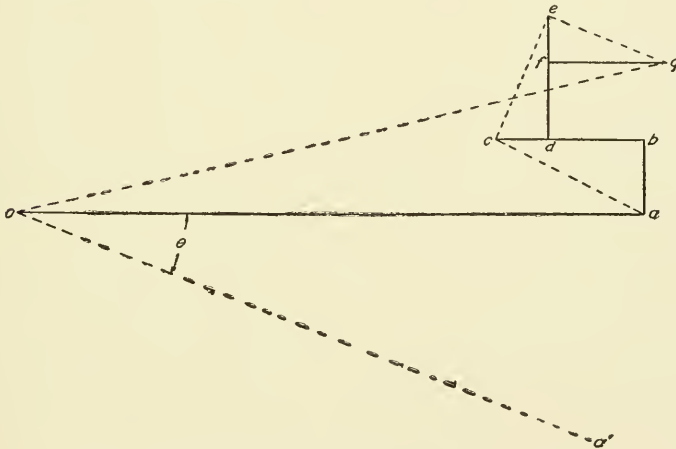

Fig. 27. Vector Diagram of Quantities Involved in Single-Phase

ing current as flowing over only one-half of the line, or one-half the charging current may be considered as flowing over all of the line.

Let the impedance of the line equal $\sqrt{R^2+\omega^2 L^2} = R+jL\omega$; the power factor of the load equal $\cos \theta$; the active component of the current equal $I \cos \theta$; the wattless component of the current equal $-jI \sin \theta$ ($-j$ indicating that the current lags 90 degrees behind the pressure).

The charging current may be represented by $+j\frac{I_c}{2}$. Then the drop due to the active component of the load is

$$I \cos \theta (R+jL\omega)$$

The drop due to the wattless component of the load is

$$-jI \sin \theta (R+jL\omega)$$

The sign of this term will be positive if the load current leads the voltage. The drop due to the charging current is

$$+j\frac{I_c}{2}(R+jL\omega)$$

The total drop is equal to the sum of these three values, or e , so that

$$E_0 = E + e = E + I \cos \theta (R+jL\omega) - jI \sin \theta (R+jL\omega) + j\frac{I_c}{2}(R+jL\omega)$$

Expanding this and substituting -1 for j^2 we have

$$E_0 = E + I \cos \theta R + jI \cos \theta L\omega - jI \sin \theta R + I \sin \theta L\omega + j\frac{I_c}{2}R - \frac{I_c}{2}L\omega$$

Referring to Fig. 27, we have these various values plotted graphically.

$$\begin{array}{ll} oa = E & ab = +j\frac{I_c R}{2} \quad bc = -\frac{I_c L\omega}{2} \\ cd = +I \cos \theta R & de = +jI \cos \theta L\omega \\ ef = -jIR \sin \theta & fg = +IL\omega \sin \theta \\ og = E_0 & \end{array}$$

ab is plotted 90 degrees in advance of oa on account of the symbol $+j$.

bc is plotted in the opposite direction from oa on account of the negative sign.

ef is plotted downward on account of the symbol $-j$.

If we let oa' , Fig. 27, represent the current vector, then θ equals angle of lag, and eg , which equals IR , is plotted parallel to oa' , and ce , which equals $IL\omega$, is plotted perpendicular to oa' .

It is seen from this that the charging current tends to produce a rise in the electromotive force instead of a drop in pressure.

The above takes into account only the constants of the line. In order to determine the regulation of a complete system, the resistance, capacity, and inductance of the translating devices must

be considered as well. A diagram of a complete system with both step-up and step-down transformers connected in service is shown in Fig. 28. The charging current may be considered as flowing

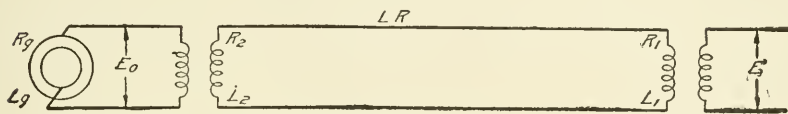

Fig. 28. Diagram of Complete Single-Phase System, with Transformers in Service

through half of the system only, viz, the generator, the step-up transformers, and one-half of the line.

Let R_1 equal the equivalent resistance of the step-down transformers; R_2 equal the equivalent resistance of the step-up transformers; L_1 equal inductance of the step-down transformers; L_2 equal inductance of the step-up transformers; R_g equal equivalent resistance of the generators; L_g equal equivalent inductance of the generators; R equal resistance of the line; L equal inductance of the line; L_T equal $L_1 + L_2 + L_g + L$; and R_T equal $R_1 + R_2 + R_g + R$.

All quantities should be converted into their equivalent values for the full line pressure. Thus, the generator and receiver voltages should be multiplied by the ratio of transformation of the step-up and step-down transformers, respectively, to change them to the full line pressure. The resistance and inductance of the transformers must include the resistance and inductance of both windings, and the value must correspond to the line voltage. Thus, the resistance of the step-up transformers will be

$$r_1 n^2 + r_2$$

where r_1 equals the resistance of the primary coil; r_2 equals the resistance of the secondary coil; and n equals the ratio of transformation. The equivalent resistance of the step-down transformers will be

$$r_1 + n^2 r_2$$

The generator resistance and inductance must be multiplied by n^2 to bring them to equivalent values for the full line pressure.

The formula then becomes

$$E_0 = E + I \cos \theta (R_T + j L_T \omega) - j I \sin \theta (R_T + j L_T \omega) + j I_c \left[\left(\frac{R}{2} + R_2 + R_g \right) + j \omega \left(\frac{L}{2} + L_2 + L_g \right) \right]$$

Referring to Fig. 27, we have these various values plotted graphically:

$$\begin{array}{ll}
 oa = E & cd = I \cos \theta R_T \\
 ab = j I_c \left(\frac{R}{2} + R_2 + R_g \right) & de = j I \cos \theta L_T \omega \\
 bc = -I_c \omega \left(\frac{L}{2} + L_2 + L_g \right) & ef = -j I R_T \sin \theta \\
 & fg = I L_T \omega \sin \theta \\
 & og = E_0
 \end{array}$$

The numerical value of E and E_0 may be determined from a diagram such as is shown in Fig. 27, when constructed to scale; or it may be calculated analytically, remembering that the quantities affected by j are to be combined, geometrically, with the quantities not affected by the symbol, that is, *the numerical value is the square root of the sum of the squares of the quantity not affected by j and the quantity affected by j .*

The above formulas apply to single-phase circuits directly. If they are to be used for the calculation of three-phase circuits, the following points must be observed:

1. Charging current I_c , three-phase = $\frac{2}{\sqrt{3}}$ × charging current single-phase.
2. The voltage should preferably be considered as the voltage between one line and the neutral point. The voltage to the neutral point will be the line voltage divided by $\sqrt{3}$.
3. The resistance of one line only is considered, not the resistance of a loop.
4. The inductance of one line only is used. The inductance of one line equals the inductance of a loop divided by $\sqrt{3}$.
5. Three-phase systems may be calculated by considering them as single-phase systems with two wires of the same size and spacing but with only *one-half* the amount of power transmitted.

Examples. 1. What is the capacity, in microfarads, between wires of a single-phase transmission line 10 miles in length composed of No. 6 copper wires spaced 15 inches apart? What is the capacity to the neutral point?

$$C \text{ in microfarads} = \frac{19.42 \times 10^{-3}}{\log \frac{2.1}{d}} \text{ per mile of circuit}$$

$$\begin{aligned}
 A &= 15 \text{ inches} & d &= .162 \text{ inches} \\
 \frac{2A}{d} &= 185 & \log 185 &= 2.2672 \\
 C \text{ in microfarads} &= \frac{19.42 \times 10^{-3}}{2.2672} \times 10 = .085
 \end{aligned}$$

with respect to the neutral point

$$\begin{aligned}
 C \text{ in microfarads} &= \frac{.0776}{2 \log \frac{2A}{d}} \\
 &= \frac{.0776}{2 \times 2.2672} \times 10 = .171
 \end{aligned}$$

This shows that the capacity to the neutral point is twice the capacity to the other wire.

2. What is the self-inductance of one loop of the above circuit, assuming it to be a three-phase instead of a single-phase system?

$$\begin{aligned}
 L &= .000558 \left(2.303 \log \frac{2A}{d} + .25 \right) \text{ per mile of circuit} \\
 &= .000558 (2.303 \times 2.2672 + .25) \times 10 \\
 &= .000558 \times 5.47 \times 10 = .0305 \text{ henrys}
 \end{aligned}$$

3. A circuit has a capacity of .2 microfarads. What must be the value of its inductance to compensate for this capacity at 60 cycles?

$$C = \frac{1}{(2\pi f)^2 L}, \text{ or } L = \frac{1}{(2\pi f)^2 C}$$

in which $C = .0000002$ farads; $(2\pi f)^2 = (2 \times 3.1416 \times 60)^2 = 142,122$;
 $\therefore L = 1 \div (142,122 \times .0000002) = 35.2$ henrys.

4. It is desired to transmit 1,000 kw. a distance of 25 miles at a voltage of 20,000, a frequency of 60 cycles, and a power factor of 85 per cent. Transmission is to be a three-phase three-wire system. Allowing 10 per cent loss of delivered power in the line, it is required to find (a) *area of conductor*, (b) *current in each conductor*, (c) *volts lost in line*; and (d) *pounds of copper*.

$$\text{Area of conductor} = \frac{D \times W \times C'}{p \times E^2}$$

in which $D = 25 \times 5,280 = 132,000$; $W = 1,000 \times 1,000 = 1,000,000$; C'

=1,500 for three-phase three-wire system and 85 per cent power factor; $p=10$; $E=20,000$; and $E^2=400,000,000$.

$$\begin{aligned}\text{Area of conductor} &= \frac{132,000 \times 1,000,000 \times 1,500}{10 \times 400,000,000} \\ &= \frac{132 \times 1,500}{4} = 49,500 \text{ circular mils}\end{aligned}$$

No. 3 wire has a cross-section of 52,630 circular mils.

$$\text{Current in each conductor} = \frac{W \times T}{E}$$

in which $T=.68$ for three-phase system, 85 per cent power factor.

$$\text{Current in each conductor} = \frac{1,000,000 \times .68}{20,000} = 34$$

$$\text{Volts lost in line} = \frac{p \times E \times B}{100}$$

in which $B=1.18$ for No. 3 wires, 60 cycles and 85 per cent power factor.

$$\text{Volts lost in line} = \frac{10 \times 20,000 \times 1.18}{100} = 2,360$$

$$\text{Pounds copper} = \frac{D^2 \times W \times C' \times A}{p \times E^2 \times 1,000,000}$$

or it may be calculated directly from the weight of wire given in the tables after the size of wire has been determined by other formulas. Thus 75 miles of No. 3 wire is required. This weighs 159 pounds per 1,000 feet.

$$159 \times 5.280 \times 75 = 62,964 \text{ pounds}$$

5. A single-phase line 20 miles in length is constructed of No. 000 wire strung 24 inches apart. It is desired to transmit 500 kw. over this line at a frequency of 25 cycles and a power factor of 80 per cent, the voltage at the receiver end being 25,000. Considering the line drop only, what must be the voltage at the generator end of the line?

$$\begin{aligned}E_0 &= E + I \cos \theta R + j I \cos \theta L\omega - j I \sin \theta R \\ &\quad + I \sin \theta L\omega + j \frac{I_c}{2} R - \frac{I_c}{2} L\omega\end{aligned}$$

in which $E = 25,000$; $I^* = \frac{500,000}{25,000 \times .80} = 25$:

$\cos \theta = .80$; $\sin \theta = .60$ (from trigonometric tables); R = resistance of 40 miles of No. 000 wire = 14.56 ohms at 50°C ; $L = .00277 \times \frac{2}{\sqrt{3}} \times 20 = .064$ (calculated from Table VII); $\omega = 2\pi f = 2\pi \times 25 = 157$;

$$I = \frac{E \times C \times 2\pi \times f}{2 \times 10^6} = \frac{25,000 \times .3752 \times 157}{2 \times 1,000,000} = .736 \text{ amperes; and}$$

$C = .3752$ (Table VI, or calculated)

Substituting these values in the above formula we have

$$E_0 = 25,000 + 291.2 + j200.8 - j218.4 + 150.6 + j5.36 - 3.7$$

$$E_0 = 25,000 + 291.2 + 150.6 - 3.7 + j(200.8 - 218.4 + 5.36)$$

$$E_0 = 25,000 + 291.2 + 150.6 - 3.7 + j(218.4 - 200.8 - 5.36)$$

Since the symbol j indicates that the quantities must be combined geometrically, then

$$E_0 = \sqrt{(25,000 + 291.2 + 150.6 - 3.7)^2 + (218.4 - 200.8 - 5.36)^2}$$

$$E_0 = \sqrt{(25,438.1)^2 + (12.24)^2} = 25,438.1 \text{ volts}$$

6. A three-phase line 20 miles in length is constructed of No. 000 wire strung 24 inches apart. We wish to transmit 1,000 kw. over this line at a frequency of 25 cycles and a power factor of 85 per cent, the voltage at the receiving end being 2,000. Three \mathbf{Y} -connected 500-kw. transformers having a ratio of 10 : 1, step the voltage up and down at either end of the line. The resistance of the high-tension winding of each transformer is 4 ohms. The resistance of the low-tension windings is .04 ohms. The inductance of each transformer is .4 henrys. Neglecting the generator constants, what must be the voltage applied to the low-tension windings of the step-up transformers?

$$E_0 = E + I \cos \theta (R_T + j L_T \omega) - j I \sin \theta (R_T + j L_T \omega) \\ + j I_e \left[\left(\frac{R}{2} + R_2 \right) + j \omega \left(\frac{L}{2} + L_2 \right) \right]$$

Since this is for a three-phase circuit we will work with the voltage to the neutral point and will change all values to correspond to the line voltage. Hence,

$$\text{*Power} = IE \cos \theta.$$

$$\frac{E_0}{\sqrt{3}} \times 10 = \frac{E}{\sqrt{3}} \times 10 + \dots\dots\dots$$

$$I = 34 \text{ amperes} \quad \left\{ \begin{array}{l} \text{Since } \sqrt{3} IE \cos \theta = 1,000,000 \\ E = 10 \times 2,000 = 20,000 \\ \cos \theta = .85 \\ I = 34 \end{array} \right.$$

R_T = Resistance of one line + equivalent resistance of one transformer at each end of the line.

$$R_T = 7.28 \text{ ohms} + 4 + 100 \times .04 + 4 + 100 \times .04 \\ = 23.28 \text{ ohms}$$

$$I_{T_1} = .0554 \div \sqrt{3} + .4 + .4 = .832 \text{ henrys} \\ \omega = 157$$

$$\sin \theta = .52$$

$$I_c = .589 \times \frac{2}{\sqrt{3}} = .677 \text{ amperes} = \text{charging current single-} \\ \text{phase} \times \frac{2}{\sqrt{3}}$$

$$\frac{R}{2} = 3.64$$

$$R_2 = 8$$

$$\frac{L}{2} = .016 \qquad L_2 = .4$$

Substituting these values in our formula, we have

$$\frac{E_0 \times 10}{1.73} = \frac{20,000}{1.73} + 672.8 + j 3774 - j 411.6 + 2309 + j 7.88 - 44.2 \\ = 11,550 \times 672.8 + 2,309 - 44.2 + j (3,774 - 411.6 + 7.88) \\ = \sqrt{14,487.6^2 + 3,370.3^2} = 14,874$$

$$E_0 = 2,573 \text{ volts}$$

7. A three-phase transmission line 40 miles in length delivers 10,000 kw. at 40,000 volts, power factor 85 per cent, frequency 60 cycles. The line consists of three aluminum conductors of a cross-section equivalent to No. 0000 wire, spaced 42 inches apart. Required the potential at the generator end of the line, neglecting charging current.

Solving this as a single-phase circuit, we can assume 5,000 kw. transmitted over two conductors spaced 42 inches.

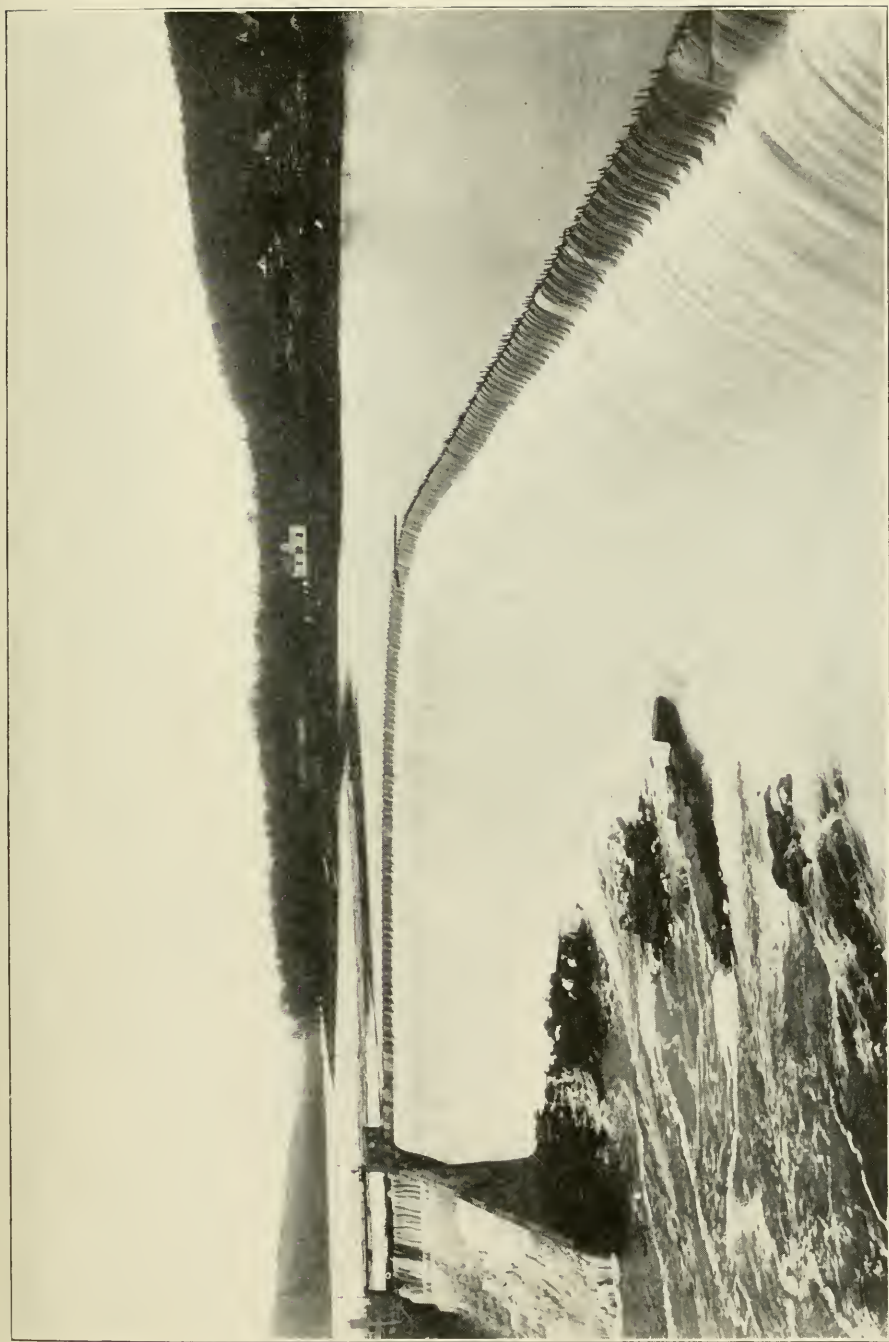

SPILLWAY OF THE DAM AT TAYLOR'S FALL PLANT, ST. CROIX RIVER, FORTY MILES NORTH OF MINNEAPOLIS, MINNESOTA

The view is taken from the corner of the power house and shows clearly the flashboards erected on the crest of the dam to increase the storage

The resistance of one mile of conductor is .432 ohm, or a total resistance for the line of $80 \times .432 = 34.56$ ohms.

The inductance of a loop is calculated as follows:

$$\begin{aligned} L &= .000644 \left[2.303 \log \frac{2A}{d} + .25 \right] \times 40 \\ &= .000644 \left[2.303 \log \frac{84}{.522} + .25 \right] \times 40 \end{aligned}$$

(No. 0000 stranded cable has a diameter of .522 inch.)

$$= .000644 \times 213.2$$

$$= .1373 \text{ henrys}$$

$$\omega = 2\pi f = 2 \times 3.1416 \times 60 = 377$$

$$I = 147 \text{ amperes}$$

$$E_o = E + I \cos \theta (R + jL\omega) - jI \sin \theta (R + jL\omega)$$

$$I \cos \theta = 147 \times .85 = 125$$

$$I \sin \theta = 147 \times .53 = 77.9$$

$$R + jL\omega = 34.56 + (j377 \times .1374) = 34.56 + j51.8$$

$$= \sqrt{(34.56)^2 + 51.8^2} = 62.1$$

$$E_o = 40,000 + (125 \times 62.1) - (j77.9 \times 62.1)$$

$$= 47762.5 - j4837.6$$

$$= \sqrt{(47762.5)^2 + (4837.6)^2}$$

$$= 48,006 \text{ volts}$$

TRANSFORMERS

A transformer consists of two coils made up of insulated wire, the coils being insulated from each other and from a core, made up of laminated iron, on which they are placed. One of these coils, known as the *primary coil*, is connected across the circuit, in constant-potential transformers, and the other coil, known as the *secondary coil*, is connected to the lamps or motors, or whatever makes up the receivers. As a matter of fact, these coils are each usually made up of several sections. The voltage induced in the secondary windings is equal to the voltage impressed on the primary winding multiplied by the ratio of the number of turns in the secondary to the number in the primary coil, less a certain drop due to impedance of the coils and to magnetic leakage. This drop is negligible on no load. If transformers are used to raise the voltage, they are termed *step-up* transformers. If used to lower the voltage, they are called *step-down* transformers.

Power Losses. Losses of power occurring in transformers are of two kinds, namely, *iron, or core, losses* which are made up of hysteresis and eddy-current losses in the iron making up the core, and *copper losses* which are due to the I^2R losses in the windings with the addition, in some cases, of eddy currents set up in the conductors themselves.

Efficiency. The efficiency of a transformer depends on the value of the power losses and may be expressed as the ratio of the watts output to the watts input.

$$\frac{W_s}{W_p} = \frac{W_p - (W_c + W_h + W_e)}{W_p}$$

Where W_s = watts secondary; W_p = watts primary; W_c = copper losses; W_h = hysteresis losses; and W_e = eddy-current losses.

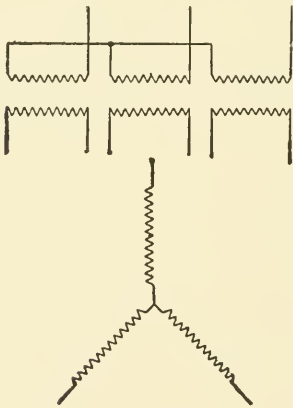

Fig. 29. Y Connections for Transformers

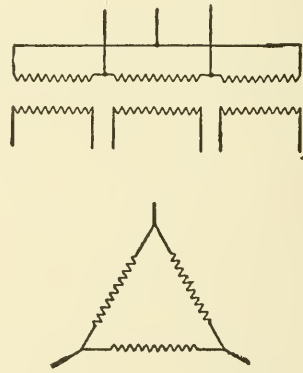

Fig. 30. Δ Connections for Transformers

The iron losses remain constant for any given voltage regardless of the load, while the copper losses are proportional to the square of the current. The efficiencies of transformers are high, varying from 94 to 95 per cent at $\frac{1}{4}$ load to 98 per cent at full load for sizes above 25 kw.

All-Day Efficiency. By all-day efficiency is meant the efficiency of a transformer, taking into consideration its operation for twenty-four hours, and it is calculated for the ratio of watt-hours output to watt-hours input for this length of time when in actual service.

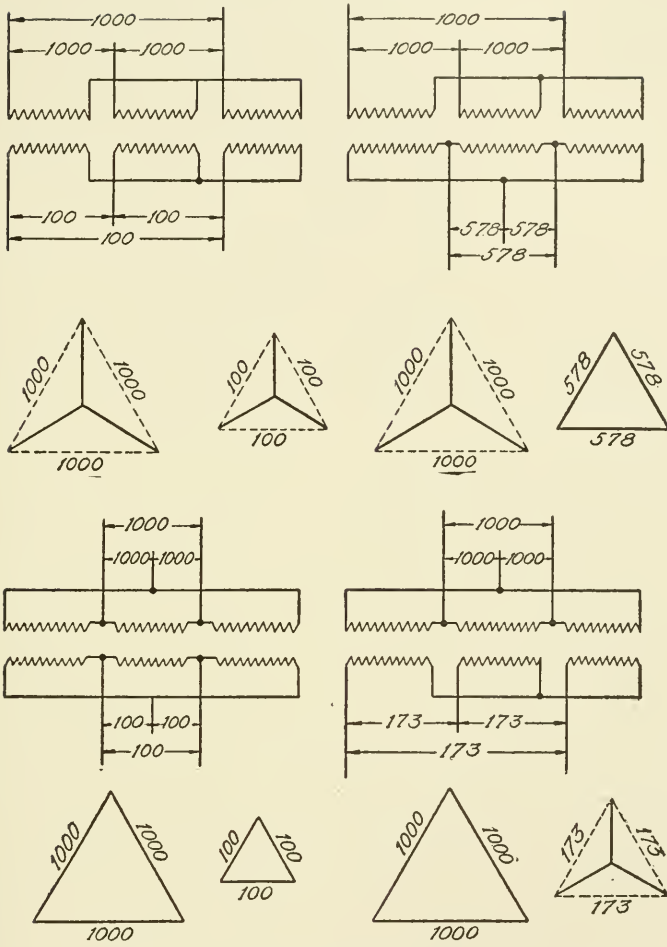

Fig. 31. Vector Diagrams of Step-down Transformers by Y and Δ Systems—Primary Voltage 1,000

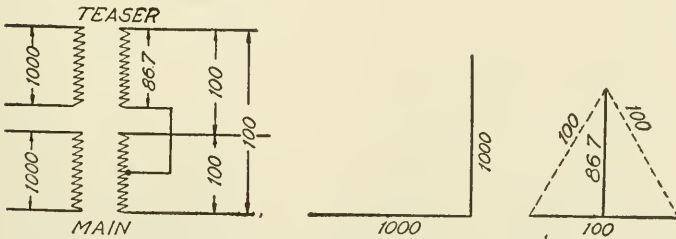

Fig. 32. Diagram of Scott Connections and Vector Diagrams for Same

For calculation, the transformer is often assumed to be fully loaded for five hours and run with no load for the remaining nineteen. The all-day efficiency is then determined as follows:

Output, kw. hours = watts output at full load \times 5

Input, kw. hours = (watts output at full load \times 5) + (I^2R loss at full load \times 5) + (core loss at normal voltage \times 24)

$$\text{All-day efficiency} = \frac{\text{output, watt-hours}}{\text{input, watt-hours}}$$

The assumption that a lighting transformer is fully loaded five hours out of the day is not always a correct one. On many circuits from two to three hours of full load would be more nearly the proper value to use in calculating the all-day efficiency.

If the efficiency of a transformer is low, it means a direct loss of considerable energy as well as greater heating of the transformer and consequent deterioration. If a transformer is to be used for lighting purposes, or is lightly loaded for a large portion of the time, a type which has a relatively low core loss should be selected so as to increase the all-day efficiency. If fully loaded all day, the

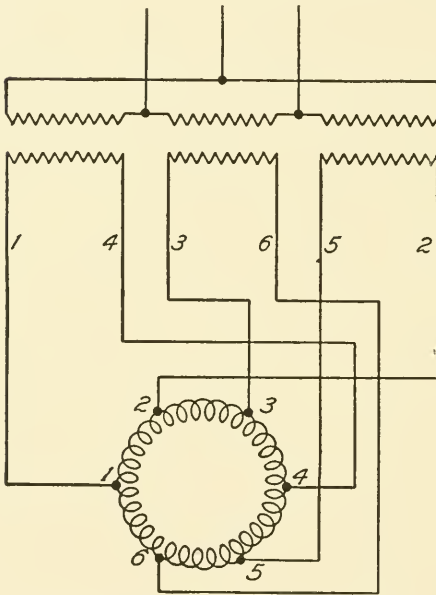

Fig. 33. Transformer Connections from Three Phase to Six-Phase for Rotary Converter

losses should be divided about equally between the copper and the iron losses.

Regulation. By regulation of a transformer is meant the percentage drop in the secondary voltage from no load to full load when normal pressure is impressed on the primary. This drop is due to the IR drop in the windings and to magnetic leakage. In well-designed transformers the loss due to magnetic leakage is about

10 per cent, or less, of that due to the resistance drop. For non-inductive load (power factor=unity) the regulation is from 1 to 3 per cent in good transformers. With induction load this is increased to 4 or 5 per cent, or even more.

Regulation should be considered carefully in selecting a transformer for given service. Thus, if a transformer is to be used for lighting, its regulation should be of the best, since drop in voltage due to the transformer is in addition to that due to the conductors. In the same way the regulation of any system as a whole depends to a certain extent on the regulation of the transformer installed.

Connections. Transformers for three-phase work may be connected in two ways. Where three transformers are used, they may be connected in **Y** or star, that is, with one terminal of each primary brought to a common point and the other terminal connected to a line wire, Fig. 29, or they may be connected in Δ or mesh when the three primaries are connected in series and the line wires are connected to the three corners of the triangle so formed, Fig. 30. The secondaries may be connected in **Y** the same as the primaries, or the secondaries may be connected in **Y** when the primaries are in Δ , or *vice versa*. The voltage relation may best be determined from vector diagrams, as shown in Fig. 31, which give the voltage relation of step-down transformers with a ratio of 10:1, when the voltage across the primary lines is 1,000.

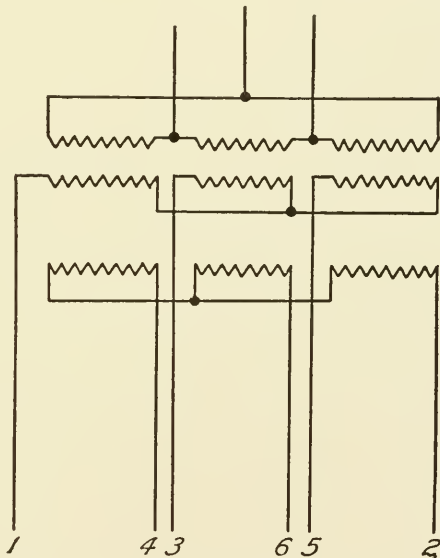

Fig. 34. Six-Phase **Y** Circuit for Transformer with Two Secondaries

Changes from two to three phases, or from three to two phases, with or without a change of voltage, may be made with transformers having the required ratio of transformation by use of the *Scott connections*. Fig. 32 shows such a connection together with a corre-

sponding vector diagram showing the relations when the change is from two phases to three phases with a 10:1 transformation of voltage. The main transformer is fitted with a tap at the middle point of the secondary winding to which one terminal of the teaser transformer is connected. The teaser has a transformation ratio differing from that of the main transformer, as shown in the figure.

Six phases are obtained from three phases for use with rotary converters by means of transformers having two secondary windings or by bringing both ends of each winding to opposite points on the rotary converter winding, utilizing the converter winding for giving the six phases. This transformer connection, Fig. 33, is known as a *diametrical connection*. When transformers with two secondaries are used, the secondaries may be connected in six-phase \mathbf{Y} or six-

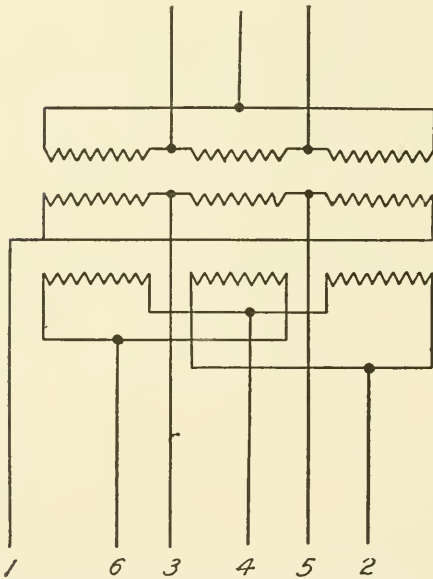

Fig. 35.—Six-Phase Δ Circuit for Transformer with Two Secondaries

phase Δ , as shown in Figs. 34 and 35. When the \mathbf{Y} -connection is used, the common connection of each set of secondaries is made at the opposite ends of the coils. This leaves the free ends directly opposite, or 180 degrees different in phase. The way in which these ends are brought out to give six phases is best illustrated by means of the two triangles arranged as shown in Fig. 36, which have their points numbered corresponding to the connections in Fig. 34. In Fig. 35 one Δ is reversed with respect to the other, and six phases are brought about in this manner.

Single transformers, constructed for three-phase and six-phase work, are now manufactured in this country, and are being used to an increasing extent. They are a little cheaper to build for the same total output, and save floor space, but are not so flexible as three single-phase transformers.

Where other conditions allow, a Δ -connection to Δ -connection is preferable, for with this connection, if one transformer is injured, it may be taken out of circuit and the remaining two will maintain the service, and may be loaded up to .57 of the former capacity of the system. In the Y -connection, however, the voltage impressed on

the transformer winding is only $\frac{1}{\sqrt{3}} = .58$

times the voltage of the line, thus making it possible to construct a transformer with a fewer number of turns. The windings must be insulated from the case, however, for a potential equal to the line potential, unless the neutral point be grounded when the potential strain to which the transformer is liable to be subjected, under ordinary condi-

tions, is reduced to $\frac{1}{\sqrt{3}}$ of its value when the neutral is not

grounded. For small transformers wound for high potential the cost is in favor of the Y -connection.

Choice of Frequency. The frequencies in extended use in this country at present are 25, 40, and 60 cycles, 25 or 60 cycles being met with more frequently than 40 cycles. Formerly a frequency of 125 or 133 cycles per second was quite often employed for lighting purposes, but these are no longer considered standard.

The advantages of the higher frequency are:

(1) Less first cost and smaller size of generators and transformers for a given output.

(2) Better adapted to the operation of arc or incandescent lamps. Lamps, when run below 40 cycles, especially low candle-power incandescent lamps at 110 volts or higher, are liable to be trying to the eyes on account of the flicker.

The disadvantages of the higher frequency are:

(1) Inductance and capacity effects are greater, hence a poorer regulation of the voltage. The charging current is directly proportional to the frequency and this amounts to considerable in a long line.

(2) There is greater difficulty in parallel operation of the high-frequency machines due to the fact that the armature reactions of the older types of high-frequency machines are high.

(3) Machines for high frequencies are not so readily constructed for operation at slow speeds. This, however, will cease to be an objection with the increasing use of the steam turbine.

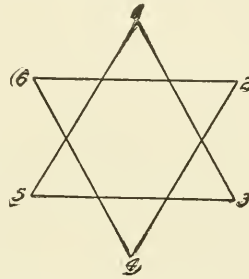

Fig. 36. " Δ " Diagram of Six-Phase Transformer Secondary Circuits

(4) Not well adapted to the operation of rotary converters and single-phase series motors on account of added complications in construction and increased commutator troubles.

A frequency of 60 cycles is usually adopted if the power is to be used for lighting only, and 25 cycles are better for railway work alone. By the use of frequency changers the frequency of any system may readily be changed to suit the requirements of the service.

OVERHEAD LINES

Having considered the calculation of the electrical constants of a transmission line and distributing system, we turn next to the mechanical features of the installation of the conductors and find two general methods of running the wires or cables, viz,

(1) The conductors are run overhead and supported by insulators attached to pins in cross-arms which, in turn, are fastened to the supporting poles.

(2) The cables are placed underground and are supported and protected by some form of conduit.

Overhead construction is used when the lines are run through open country or in small towns. It forms a cheap method of providing satisfactory service and is reliable when carefully installed. It has the advantage that the wires may be placed some distance apart and, being air-insulated, the capacity of the line is much less than that of underground conductors.

The old practice in overhead line construction has always been to consider the design and the erection of the line as work that any one could do, it being taken as the simplest part of the electrical system. As a result, the line was a source of much trouble which was laid to almost any other cause than poor construction. The overhead line, when used, must be considered as a part of the power plant and it should receive as careful attention as any part of the central station or substation. It often has to meet much more severe conditions than the power plant itself and it is responsible to a very large extent for the reliability of service.

The new way of treating the question of overhead lines is to consider them as structures which must be designed to meet certain strains just as a bridge or similar structure is designed. This is especially true when steel or iron poles are used as is the case in nearly all transmission lines abroad.

The design of an overhead line may be divided into five parts, some being purely mechanical features while others are both mechanical and electrical.

- (1) Location of line.
- (2) Poles or towers and cross-arms.
- (3) Insulators and pins.
- (4) Stresses sustained by the pole line.
- (5) Conductors.

Location of Line. The location of the line takes into account the territory over which the line must be run with respect to contour, direction, and freedom from obstructions, as well as possible right of way. Width of streets, kind and height of buildings, and liability to interference with or from other systems must be considered, when such are present. The right of way for electric lines may be secured, in some cases, along a railway or public road when its location is comparatively simple, provided it is not necessary to interfere with adjoining property. When adjoining property must be interfered with, or when the line is to run over sections containing no roads, it is usually possible to form contracts with the property owner such as shall free the line from future interference by the property owner. In general, the cost of such contracts will be comparatively low. Again, the right of way may be purchased outright, as is preferable when right of way is being secured for high-speed electric railways. When the demands for right of way are in excess of a reasonable amount, the process of condemnation of property may be resorted to or the direction of the line may be changed so as to avoid such locations. A preliminary survey of the line should be made at the time the route is being located, such a survey consisting of the approximate location of the poles, notes of the changes in direction and level of the ground as well as of its character. This survey aids in the selection of material to be delivered to the different parts of the line. Changes in level are compensated for as much as possible by selecting long poles for the low places and short poles for the higher elevations, thus reducing the unbalanced strains in the line.

The heavier poles should be used where there is a change in direction, where the line is especially exposed to the wind, or where branch lines are taken off. It is sometimes necessary that power

lines be run on the same poles as telephone wires, in which case the power conductors should, preferably, be located above the telephone wires.

Poles. In this country, the support for aerial lines consists almost universally of wooden poles to which the cross-arms, bearing the insulator pins, are attached. These poles may be either natural grown or sawed. Abroad, the use of metal poles prevails. In order to determine the proper cross-section of a pole it may be regarded as a beam fixed at one end and loaded at the other, this load consisting of the weight of the wire, with attendant snow or sleet, which tends to produce compression in the pole, and the tension of the wires together with the effect of wind pressure, which tends to produce flexure. Only the latter stresses need be considered in selecting a pole for ordinary transmission lines. The poles are in the shape of a truncated cone or pyramid, Fig. 37, the equation of which is

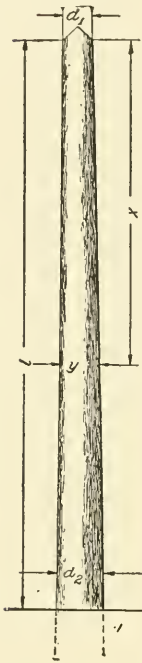

Fig. 37. Standard Line Pole

$$y = d_1 + x \left(\frac{d_2 - d_1}{l} \right)$$

where y is diameter of any section; x is distance from the top of the pole; l is length of pole; and d_1 and d_2 are diameters of the pole at the top and bottom respectively.

Taper. The proper taper for a pole should be such that d_2 equals $\frac{3}{2}$ of d_1 . If d_2 is greater than $\frac{3}{2} d_1$, the pole is heavier than need be, as it would tend to break below the ground. If d_2 is less than $\frac{3}{2} d_1$, the pole will tend to break above the ground and the material is not distributed to the best advantage.

Size. In calculating the size of pole necessary to stand a certain stress, we have, from the principles of Mechanics,

$$M = \frac{SI}{\frac{d_2}{2}}$$

where M is moment of resistance, I is moment of inertia; S is stress in the section at d_2 , at which point the pole is least able to withstand

the strain which comes on it. M equals Pl , where P is the tension in the wires and l is the length of pole in inches.

For a round pole

$$I = \frac{\pi d_2^4}{64}$$

and we have

$$Pl = \frac{S\pi d_2^4}{64} = \frac{S\pi d_2^3}{32} \cdot \frac{d_2}{2}$$

Solving for S

$$S = \frac{32Pl}{\pi d_2^3}$$

For a sawed pole with square cross-sections the value of I is

$$I = \frac{d_2^4}{12}$$

and

$$Pl = \frac{Sd_2^3}{6} \quad \text{or} \quad S = \frac{6Pl}{d_2^3}$$

The value for S should not exceed a certain proportion of the ultimate strength of the material. If T represents the ultimate strength in pounds per square inch, then $P = \frac{T}{n}$, where n is known as the factor of safety and is ordinarily not taken less than 10 for wooden structures. A high factor of safety is necessary on account of the material not being uniform, and the uncertainty of the value of T . Commonly accepted values of T are:

Yellow pine.....	5,000-12,000	pounds
Chestnut.....	7,000-13,000	pounds
Cedar.....	11,500	pounds
Redwood.....	11,000	pounds

The value of $\frac{T}{n}$ should not be over about 800 for natural poles and 600 for sawed poles.

d_2 is measured at the ground line of the pole, not at the base.

Consider a pole of circular cross-section having a length of 35 feet and a diameter at the ground line of 12 inches. Using $\frac{T}{n} = 600$,

what is the maximum allowable stress that should be applied at the end of the pole?

$$S = \frac{32 Pl}{\pi d_2^3}$$

where $P = 600$; $l = 35 \times 12 = 420$ inches; and $d_2 = 12$

$$S = \frac{32 \times 600 \times 420}{3.1416 \times 1728} = 1,485 \text{ pounds}$$

It is customary to select a general type of pole for the whole line, determined from calculations based on the above formulas, after the tension in the wire has been found, and not to apply such calculations to every section of the line. The line is then reinforced, where necessary, by means of guy wires or struts.

Some of the general requirements for poles are:

Spacing should not exceed 40 to 45 yards.

Poles should be set at least 5 feet in the ground with an additional 6 inches for every 5 feet increase in length over 35 feet. Special care in setting is necessary when the ground is soft. End and corner poles should be braced and at least every tenth pole along the line should be guyed with $\frac{1}{4}$ - or $\frac{3}{8}$ -inch stranded galvanized iron wire.

Inspection. Regular inspection of poles, at least yearly, should be maintained and defective poles replaced. The condition of poles is best determined by examination at the base.

Poles should preferably be of good, sound chestnut, cedar, or redwood. Other kinds of wood are sometimes used, the material depending largely on the section of the country in which the line is to be erected and the timber available. Natural poles should be shaved, roofed, gained, and given one coat of paint before erecting.

Preserving. Special methods of preserving poles have been introduced, chief among which may be considered the process of creosoting. Creosoting consists of treating the poles with live steam at a temperature of 225° to 250° F., so as thoroughly to heat the timber, after which a vacuum is formed, and then the containing cylinder is pumped full of the preserving material, a pressure of about 100 pounds per square inch being used to force the desired amount of material into the wood. The butts of poles are often treated with pitch or tar, but this should be applied only after the pole is thoroughly dry.

Guying. Guying of pole lines is one of the most important features of construction. Guys consist of three or more strands of wire, twisted together, fastened at or near the top of the pole, and carried to the ground in a direction opposite to that of the resulting strain on the pole line. The lower end is attached to some form of guy stub or guy anchor, which may be a tree, a neighboring pole, a short length of pole set in the ground, or a patent guy anchor. Guy stubs are set in the ground at an inclination such that the guy makes an angle of 90 degrees with the stub or with the axis of the stub in the direction of the guy, the stub in the latter case being held in place by timber or plate fastened at right angles to the bottom of the stub. Such a timber is known as a "dead man".

The angle the guy wire makes with the pole should be at least 20 degrees. When there is not room to carry the guy far enough

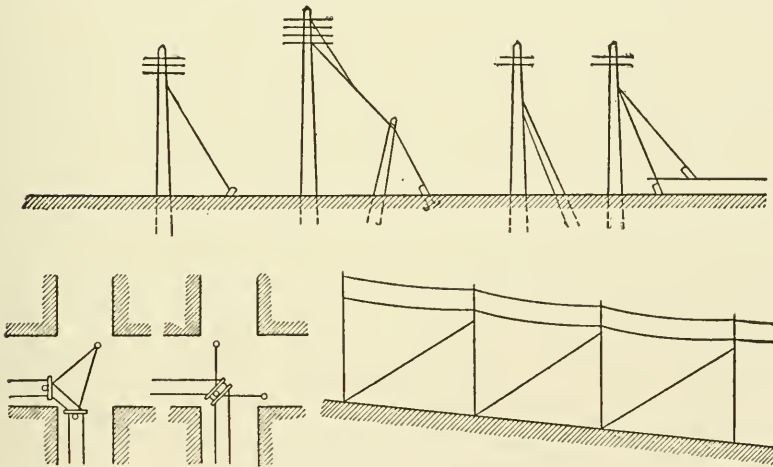

Fig. 33. Methods of Guying Poles

away from the base of the pole to bring this angle to 20 degrees or more, a strut may be used. This consists of a pole slightly shorter and lighter than the one to be reinforced. It is framed into the line pole near the top and set in the ground near the base of the pole on the opposite side from that on which a guy would be fastened.

Stranded galvanized steel guy wire is used for guys. There are two general methods of attaching the guys to the top of the pole. In the one, a single guy is run, attached at or near the middle

cross-arm, while in the other, known as **Y** guying, two wires are run to the top of the pole, one at the upper, the other at the lower arm, and are united into a single line a short distance from the pole.

Head guying, that is, guying in the direction of the line, is used when the line is changing level and for end poles. The guys are attached near the top of one pole and run to the bottom of the pole just above. Fig. 38 shows several methods of reinforcing pole lines. Special methods are adapted as necessary.

Steel Towers. Steel towers are now being used to a considerable extent, especially on important lines, because of their longer life and

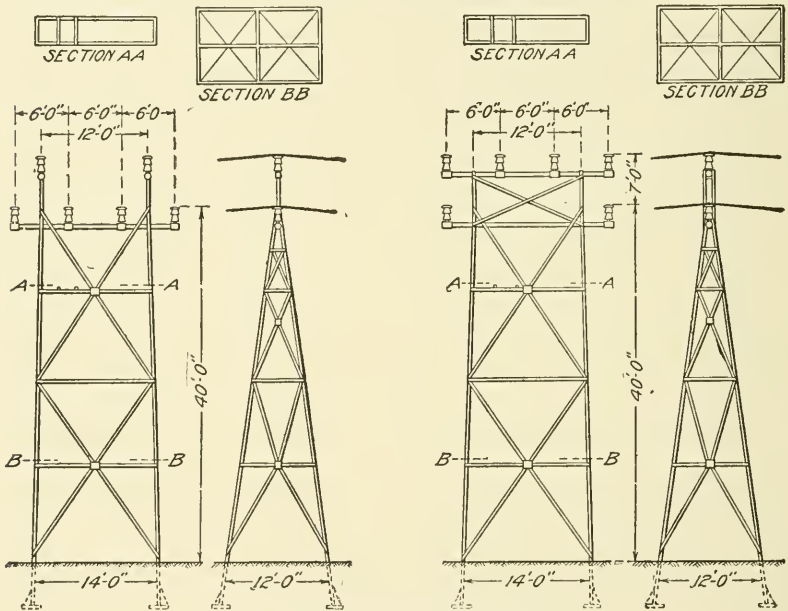

Fig. 39. Plan and Elevation of Steel Tower

greater reliability. The first cost varies from two to four times that of wood-pole line construction. These towers take a large variety of forms, one of which is shown in Fig. 39. They are spaced 8–12 to a mile on straight work and range in height from 40 to 60 feet, the higher towers being used for the longer spans. There is a saving in the number of insulators required over the number necessary for wood-pole lines. For protection and appearance the material of the towers is galvanized.

Cross-Arms. The best cross-arms are made of southern yellow pine, although oak is used to a large extent. They should be of selected well-seasoned stock. The usual method of treatment is to paint them with white lead and oil. The size of cross-arms and spacing of pins have not been thoroughly standardized. For circuits up to 5,000 volts, $3\frac{1}{2}$ -by $4\frac{1}{2}$ -inch cross-arms with spacing between pins of 12 or $14\frac{1}{2}$ inches, and the pole pins spaced 22 inches, are recommended. For higher voltages, special cross-arms and spacings are necessary. The cross-arms should be spaced at least 24 inches between centers, the top arm being placed 12 inches below the top of the pole. They are usually attached to the pole by means of two bolts and are braced by galvanized iron braces not less than $1\frac{1}{4}$ by $\frac{3}{16}$ inch and about 28 inches long.

Cross-arms are placed on alternate sides of the poles so as to prevent several of them from being pulled off should one become broken or detached. On corners or curves, double arms are used. In European practice, the cross-arm is done away with to a large extent, the wire being mounted on insulators attached to iron brackets mounted one above the other.

The distance between conductors for aerial lines is governed by the voltage of the system and the distance between supports. For ordinary work the average figures are about as follows:

From 2,300 to 6,600 volts,	2 feet 4 inches
From 10,000 to 20,000 volts,	3 feet 4 inches
From 20,000 to 30,000 volts,	4 feet 0 inches
From 30,000 to 50,000 volts,	5 feet 0 inches
From 50,000 to 60,000 volts,	6 feet 0 inches

Insulators. Electrical leakage between wires must be prevented in some way and various forms of insulators are depended upon for this purpose. The material used in the construction of these insulators should possess the following properties: (a) high specific resistance; (b) surface not readily destroyed and one on which moisture does not readily collect; (c) mechanical strength to resist both strain and vibrating shocks. Its design must be such that the wire can readily be fastened to it and the tension of the wire be transmitted to the pin without producing an excessive strain in the insulator. Leakage surface must be ample for the voltage of the line and so constructed that a large portion of it will be protected from mois-

ture during rainstorms. The principal materials used are glass and porcelain.

Porcelain has the advantage over *glass* in that it is less brittle and generally stronger and is less hygroscopic, that is, moisture does not so readily collect on and adhere to its surface. Glass is less conspicuous and is cheaper for the smaller insulators. Both materials are freely used for the construction of high-tension lines, while the use of glass prevails for the low-tension circuits.

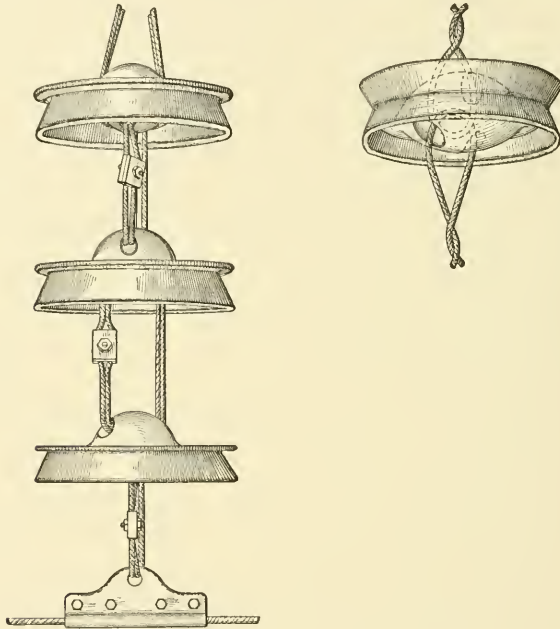
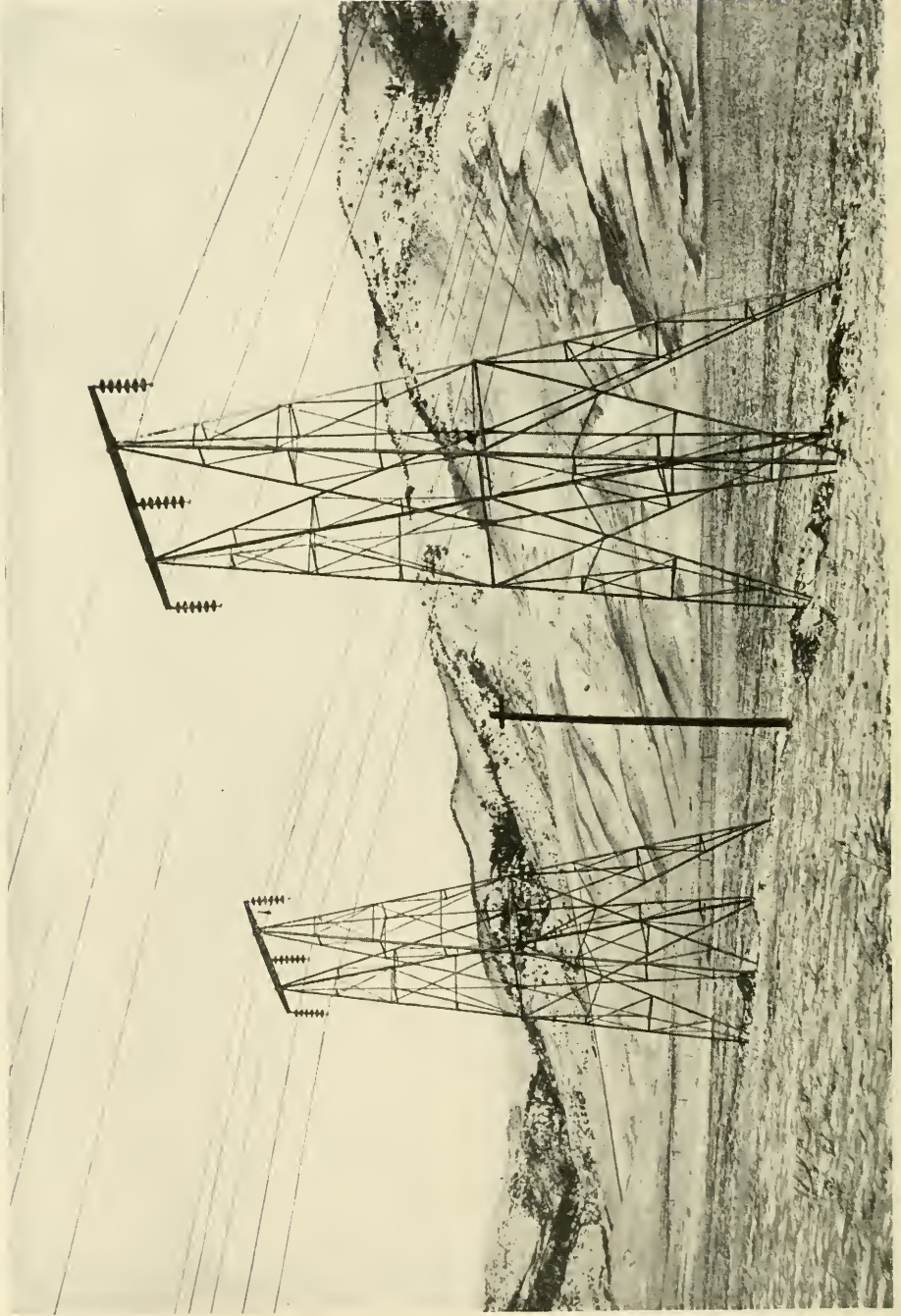

Fig. 40. Suspended or Disk Type of Insulator

Many line insulators are of the *petticoat type* and are made up in various shapes and sizes. The larger size porcelain insulators are made up in two or more pieces which are fastened together by means of a paste formed of litharge and glycerin. The advantages of this form of construction are greater uniformity of structure, and that each part may be tested separately.

For the higher potentials—voltages from 60,000 to 110,000—a *suspended or disk type* of insulator is now in use, its construction being shown in Fig. 40. The advantages of this insulator are: (1)



VIEW OF HIGH TENSION LINES OF MONTANA POWER COMPANY NEAR ADEL, MONTANA

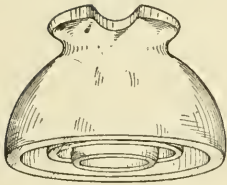

HEIGHT $3\frac{3}{4}$ "
TESTED AT 50,000V.



HEIGHT 3"
TESTED AT 30,000V.

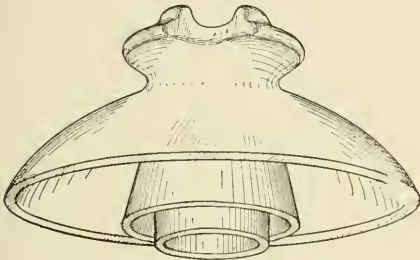

HEIGHT $4\frac{1}{2}$ "
TESTED AT 70,000V.

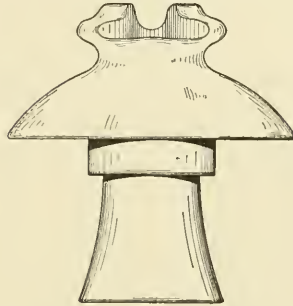

HEIGHT $7\frac{1}{4}$ "
TESTED AT 80,000V.

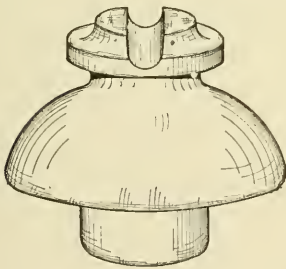

HEIGHT $4\frac{3}{8}$ "
TESTED AT 50,000V.

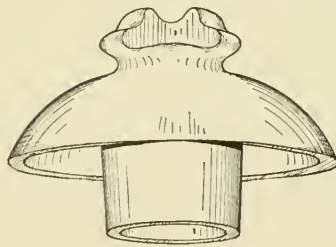

HEIGHT $4\frac{1}{2}$ "
TESTED AT 50,000V.



HEIGHT $3\frac{1}{2}$ "
TESTED AT 40,000V.

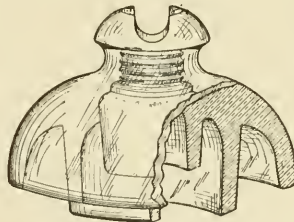

HEIGHT $4\frac{1}{2}$ "
TESTED AT 40,000V.

Fig. 41. Types of Petticoat Insulators

by using the proper number of disks in series, the higher line potentials become practical; (2) the material is subjected to compressive strains only; and (3) there is likelihood of less torsional strain on the cross-arms. A slight additional height of pole is necessary and the line wires must be anchored at intervals to prevent excessive swaying.

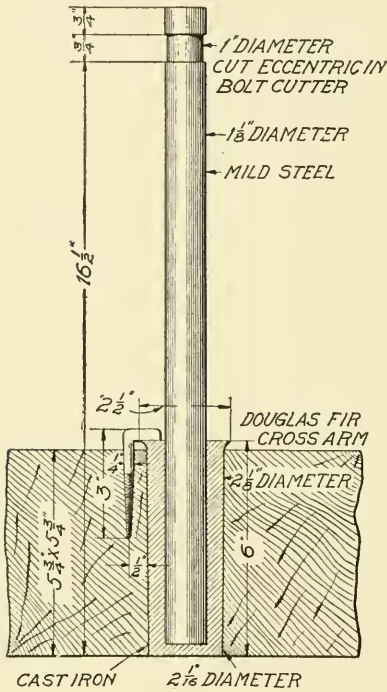

Fig. 42. Iron Pin Showing Dimensions

of a thread in a lead lug which is cast on top of the pin. The insulators in the construction shown in Fig. 42 are cemented to the iron brackets.

Line Stresses. The stresses sustained by the line may be classified as follows:

1. Weight of wire, which includes insulation, and snow and sleet which may be supported by the wire.
2. Wind pressure upon the parts of the line.
3. Tension in the wire itself.

Weight of Wire. The strain produced by the weight of the wire on the pole itself need not be considered except in exceptional cases,

Fig. 41 shows several forms of petticoat insulators now in use with the voltage at which they are tested. The test applied to an insulator for high-tension lines should be at least double the voltage of the line, and some engineers recommend three times the normal voltage.

Pins. Pins made of locust wood boiled in linseed oil are preferred for voltages up to 5,000. Above this, special pins are used. Wood pins are often objected to on account of the burning or charring which takes place in certain localities. Iron pins are now being used to a large extent. The dimensions of such a pin used on a 60,000-volt line are given in Fig. 42. Other forms of pins are shown in Fig. 43. The insulator is fastened to the pin by means

because if the pole is sufficiently strong to withstand the bending strains, it is more than strong enough to withstand the compression.

Wind Pressure. Langley shows the pressure of the wind normal to flat surfaces to be equal to

$$p = .0036 v^2 = \frac{v^2}{280}$$

where p is pressure in pounds per square feet and v is velocity in miles per hour.

For cylindrical surfaces the amount of pressure is two-thirds of that exerted on a flat surface of a width equal to the diameter of the cylinder. Without great error we may assume that the maximum wind pressure, and that for which calculation is necessary, is that at right angles to the line, and a value of thirty pounds per square

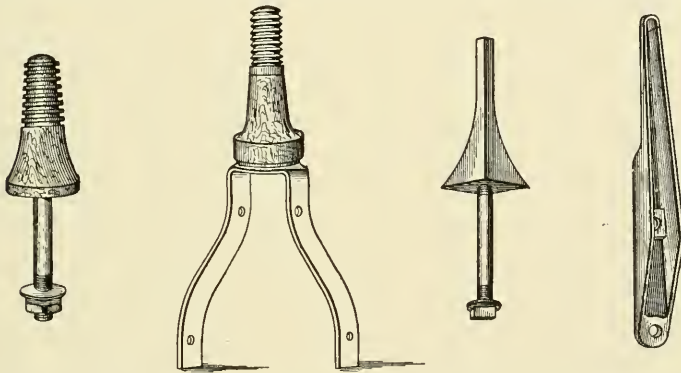

Fig. 43. Forms of Pins. Cross-Arm 2300-6600 Volts; Pole-Top 2300-6600 Volts; Cross-Arm 10,000-30,000 Volts; Pole-Top 10,000-30,000 Volts

foot is sufficient allowance for exposed places, while twenty pounds per square foot is sufficient for lines partially sheltered.

Example. What is the pressure, due to the wind, on the wires of a pole line containing three No. 0000 wires, the poles being spaced 45 yards and the velocity of the wind such that the pressure may be taken at 30 pounds per square foot?

The diameter of a No. 0000 wire is .460 inch. The area against which the wind exerts its force may be considered as

$$\frac{2}{3} \times \frac{3 \times 45 \times 3 \times 12 \times .460}{144} = 10.35 \text{ square feet}$$

$$\therefore 10.35 \times 30 = 310.5 \text{ pounds}$$

Tension. The most important strain-producing factor in a line is that due to the tension in the wire itself. A wire suspended so as to hang freely between two supports assumes the form of curve known as a *catenary*, but for ordinary work the curve may be taken as a *parabola*, the equation of which is simple and from which the following equations are derived:

$$D = \frac{H^2 W}{8 P_c}$$

$$P_c = \frac{H^2 W}{8 D}$$

$$L = H + \frac{8 D^2}{3 H}$$

When D is deflection or sag at lowest point in feet; L is actual length of wire between supports in feet; H is distance between supports in feet; W is weight of wire in pounds per foot; and P_c is horizontal tension in the wire at the middle point.

$$P_c = \frac{T}{n}$$

where T is tensile strength of the wire and n is factor of safety; $n=2$ to 6 under the conditions existing when the wire is erected. The temperature changes in the wire affect the value of this factor, it being a maximum when the temperature is the greatest, and a minimum when the temperature is the lowest, and calculation should be for the maximum strain that may come on the wires.

if L_t is length of a wire at a given temperature, t° F., and L_{20} is length of a wire at a given temperature, 20° F., then

$$L_t = L_{20} [1 + k (t - 20)]$$

Values of k per degree Fahrenheit for materials used for line wires are given as follows:

Steel.....	0.0000064
Aluminum.....	0.0000128
Copper.....	0.0000096

On account of the fact that the conductor is elastic, the full

TABLE IX
Temperature Effects in Spans

SPANS IN FEET	TEMPERATURE IN DEGREES FAHRENHEIT								
	-10°	30°	40°	50°	60°	70°	80°	90°	100°
	Deflection in Inches								
50	.5	6	8	9	9	10	11	11	12
60	.7	8	10	11	11	12	13	13	14
70	1.	10	11	12	13	14	15	15	17
80	1.2	11	13	14	15	16	17	18	19
90	1.6	13	14	16	17	18	19	20	21
100	1.9	14	16	17	19	20	21	23	24
110	2.3	16	18	19	21	22	24	25	26
120	2.8	17	19	21	22	24	26	27	28
140	3.7	20	23	25	27	28	30	32	33
160	4.9	23	26	28	30	32	34	36	38
180	6.2	26	29	32	34	37	39	41	43
200	7.7	31	33	36	38	41	43	45	48

value of k as given above does not apply, as with higher temperatures the strain on the wire is reduced and the elasticity of the material reduces the actual length of wire between supports. On this account the values to be used in line calculations should be about one-third those given above for copper and aluminum and one-half the above value for steel.

Example. A galvanized steel wire having a tensile strength of 45,000 pounds per square inch and weighing 330 pounds per mile is strung on poles spaced 35 to the mile. It is so strung that at 0° F. the actual length of wire between supports is 150.80754 feet. What will be the length of wire between supports when the temperature is raised to 80° F.?

Use for k a value equal to $\frac{1}{2}$ of 0.0000064, or 0.0000032. Then

$$\begin{aligned} L &= 150.80754 (1 + 0.0000032 \times 80) \\ &= 150.80754 \times 1.000256 = 150.846 \text{ feet} \end{aligned}$$

Ans. 150.846 feet.

Table IX gives the deflection of spans of wire in inches for different temperatures and different distances between poles, a maximum stress of 30,000 pounds per square inch being allowed at -10° F., which gives a factor of safety of 2 for hard-drawn copper wire.

The above formulas apply directly to lines in which the poles are the same distance apart and on the same level, and any number of spans may be adjusted at one time by applying the calculated stress at the end of the wire, and the line will be in equilibrium, that is, there will be no strain on the poles in the direction of the wires. Special care must be taken to preserve this equilibrium when the length of span changes or when the level of the pole tops varies, and this is accomplished by keeping P_c and n constant for every span.

Example. What is the tension in pounds per square inch at the center of a span of No. 0000 wire, when the poles are 120 feet apart and the sag is 16 inches?

$$P_c = \frac{H^2 W}{8D}$$

$$H = 120$$

$$D = \frac{16}{12} = 1\frac{1}{3} \text{ feet}$$

$$W = .64 \text{ pounds}$$

$$\therefore P_c = \frac{(120)^2 \times .64}{8 \times 1\frac{1}{3}} = 864 \text{ pounds}$$

The cross-section of No. 0000 wire is

$$\pi \times (.23)^2 = .1662 \text{ square inches}$$

$$864 \div .1662 = 5,200 \text{ pounds per square inch}$$

By making use of the modulus of elasticity* of the material employed for the line, the actual length of the conductor under different strains may be determined and from this elongation the length of the wire, if not subjected to stress, may be found. With the length of the conductor, when not subjected to stress, known, the length of the unstressed conductor at any different temperature may be determined by using the true coefficient of expansion in the formula already given. As the temperature changes, the sag and the strain on the conductor both change, and the wire will, of course, take up such a position that the strain due to the weight of the wire and the wind will just be balanced by the strain due to its elasticity.

If E equals the elongation of the conductor due to stress, M equals the modulus of elasticity, and a equals the area, then

*Modulus of elasticity is defined as the stress required to stretch a bar to twice its original length, assuming the material to remain perfectly elastic.

$$E = \frac{P_c L}{Ma}$$

For the different materials used in line construction M may be taken as follows:

Aluminum.....	9,000,000
Copper, hard drawn.....	16,000,000
Steel.....	27,000,000

The calculation of a line in which use is made of the modulus of elasticity of the material and the true coefficient of expansion is given in the following example.

Example. Find the deflection and the length of the cable as strung when at -20° F. and stressed to the elastic limit, when the distance between supports equals 1,000 feet; the conductor is a 500,000 circular mil aluminum cable; the area is .393 square inch; weight is .46 pound per foot; the elastic limit of wire is 5,500 pounds; and the modulus of elasticity is 9,000,000.

Assume a wind pressure such that the resultant of the wind and the weight of the conductor amount to .85 pound per foot, and that at -20° F., the cable is stressed to the elastic limit. What will be the deflection and the tension on the cable when the line temperature is raised 130° F.?

$$D = \frac{1,000^2 \times .85}{8 \times 5,500} = 19.3 \text{ feet}$$

$$L = 1,000 + \frac{8 \times 19.3^2}{3,000} = 1,000.992 \text{ feet}$$

$$E = \frac{5,500 \times 1,000.992}{9,000,000 \times .393} = 1.56 \text{ feet}$$

Length of conductor unstressed equals

$$1,000.992 - 1.56, \text{ equals } 999.432 \text{ feet}$$

Length of conductor unstressed at 130° F. equals

$$999.432 (1 + 150 \times .0000128), \text{ equals}$$

$$1,001.352 \text{ feet. This would correspond to}$$

$$\epsilon \text{ deflection of } 22.5 \text{ feet.}$$

When the cable is stressed as it is when supported at points 1,000 feet apart, the cable will sag more than 22.5 feet and the simplest manner of finding this deflection and the resultant tension is to assume different tensions in the wire and calculate the deflections from the equation

$$D = \frac{H^2 W}{8P_e}$$

and plot the values in a curve AB , Fig. 44. Next calculate, from

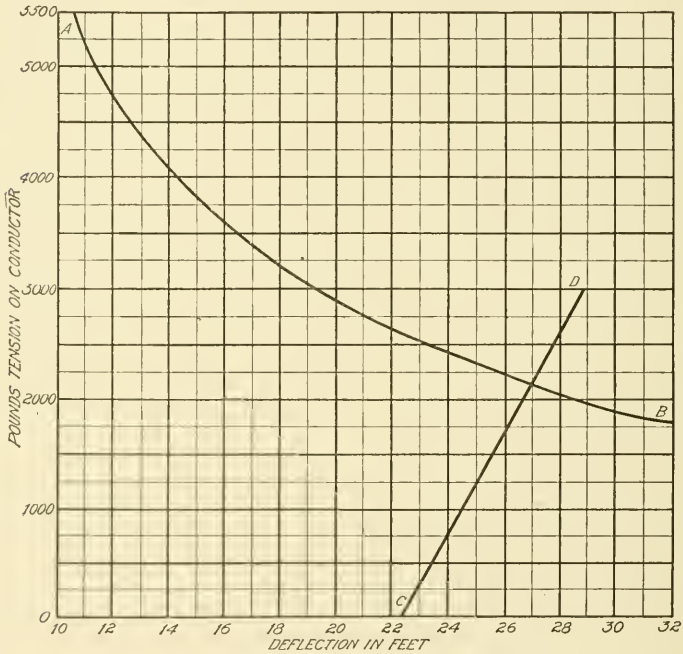

Fig. 44. Graphical Solution of Example, Page 71

the formula, the increase in the length of the conductor for each deflection, using the modulus of elasticity, and obtain the deflection

$$D = \sqrt{\frac{3}{8}HL - \frac{3}{8}H^2}$$

and plot the curve CD , Fig. 44. The point where these two curves cross gives the resultant deflection and tension.

Ans. Deflection, 27 feet; Tension, 2,150 pounds.

The regulation of the system and the amount of power lost in transmission together determine the cross-section of the conductors to be used. The amount of power lost, for most economical operation, can be determined from the cost of generating power and the fixed charges on the line investment.

Conductors. The most economical conductor to use is the one which makes the sum of the annual charges for line and the annual charges for energy lost in the line a minimum. In general, it can best be determined by assuming about three sizes of conductor and calculating the total annual charges for each size, selecting the most economical one for the construction. Total annual charges can be determined only when all local conditions are known. Usually the loss of power will not exceed 10 per cent of the amount delivered. Either copper or aluminum wire or cables may be used although copper is the more common. Aluminum is lighter in weight than copper, but more care is necessary in erecting it and it is more difficult to make joints.

UNDERGROUND CONSTRUCTION

In large cities or other localities where, if overhead construction be used, the number of conductors becomes so great as to be objectionable, not alone on account of appearance but also on account of complication and danger, the lines are run underground. The expense of installing underground systems is very great compared with that of overhead construction, but the cost of maintenance is much less and the liability to interruption of service, due to line troubles, is greatly reduced. The essential elements of an underground system are the conductor, the insulator, and the protection. The conductor is invariably of copper, the insulator may be rubber, paper, some insulating compound, or individual insulators, depending on the system, while the protection takes one of several forms.

Systems. The system, as a whole, may be divided into (a) solid, or built-in, systems; (b) trench systems; and (c) drawing-in systems.

Solid, or Built-In. As an example of the solid, or built-in, system, we have the *Edison tube* system, which is especially adapted to house-

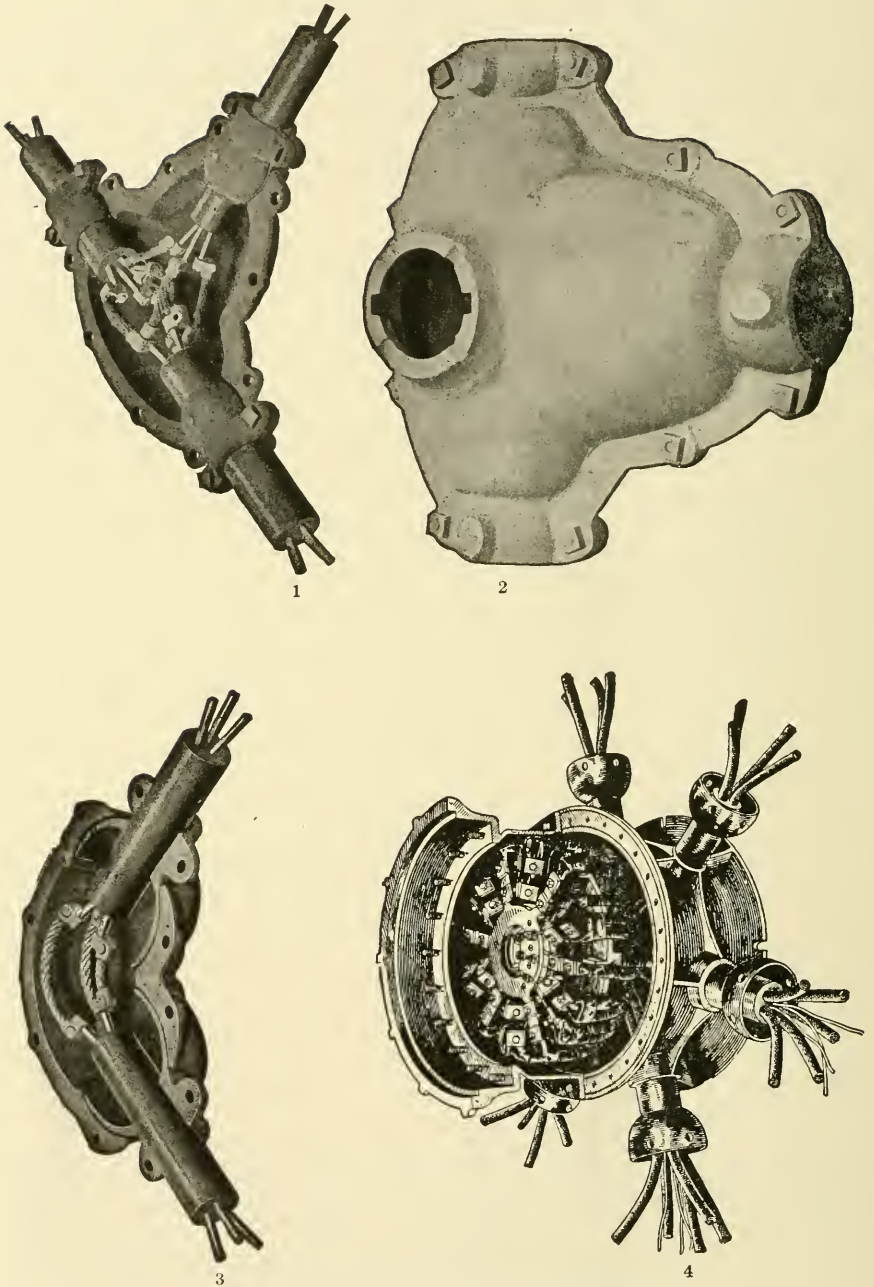

Fig. 45. Coupling Boxes Used in Edison Tube System

to-house distribution and is used to some extent for direct-current three-wire distribution in congested districts. It is made up of copper rods as conductors—three of equal size for mains and the neutral but one-half the size of the main conductors in feeders—which are insulated from each other by an asphaltum compound. This compound also serves as an insulation from the protecting case, which consists of wrought-iron pipe. Pilot wires are also often installed in the feeder tubes. This tube is built up in sections about 20 feet long. In insulating the conductors, they are first loosely wrapped with jute rope so as to keep them from making contact with each other and with the pipes, and the heated asphaltum forced into the tube from the bottom, when the tube is in a vertical position. The ends of the conductors and the tubes must be joined and properly insulated in a completed system. Special connectors are furnished for the conductors, and cast-iron coupling boxes are fitted to the ends of the tube, as shown in Fig. 45. After the conductors are properly connected, the cap is put on this coupling box and the inside space then filled with insulating compound through a hole in the cap. This hole is later fitted with a plug to render the box air-tight. The system is a cheap one, though the joints are expensive. It is not adapted to high potentials.

The *Siemens-Halske* system of iron-taped cables consists of insulated cables encased in lead to keep out moisture, this lead sheathing being in turn wrapped with jute which forms a bedding for the iron tape. The iron tape is further protected by a wrapping thoroughly saturated with asphaltum compound. These cables may be made up in lengths of from 500 to 600 feet.

In unexposed places, such as across private lands, the steel taping may be omitted and the lead sheathing simply protected by a braid or wrapping saturated with asphaltum.

Trench System. The trench system consists of bare or insulated conductors supported on special forms of insulators as in overhead construction, the whole being installed in small closed trenches. This system is not used to any extent in America.

In the *Crompton* trench system, bare copper strips are used, each 1 to $1\frac{1}{2}$ inches wide and $\frac{1}{4}$ to $\frac{1}{2}$ inch thick. These strips rest in notches on the top of porcelain or glass insulators, supported by oak timbers which are embedded in the sides of a cement-lined trench.

This trench is covered with a layer of flagstone. The insulators are spaced about 50 feet, and about every 300 feet a straining device is installed for taking up the sag in the conductors. Handholes are located over each insulator.

Drawing-In Systems. There are a number of drawing-in systems, of which several have come to be considered standard underground construction in the United States. It is no longer deemed advisable to construct ducts which will serve as insulators, but they are depended on for mechanical protection only, and should fulfil the following requirements:

They must have a smooth interior, free from projections, so that the cables may readily be drawn in and out.

They must be reasonably water-tight.

They must be strong enough to resist injury due to street traffic and accidental interference from workmen.

Conduit Materials. Among the materials used for duct construction are iron or steel, wood, cement, and terra cotta.

Wood. Wood is used in the form of a trough or box, or in the form of wooden pipes. The latter is known as *pump log* conduit. The wood used for this purpose must be very carefully seasoned and then treated with some antiseptic compound, such as creosote, in order that the duct may give satisfactory service. If improperly treated, acetic acid is formed during the decay of the wood, and this attacks the lead covering of the cable, destroying it and allowing moisture to deteriorate the insulation. Wood offers very little resistance to the drawing in of the cables, and it is a cheap form of conduit, though it cannot be depended on for long life.

Wrought Iron. One of the best and at the same time most expensive systems is the one using wrought-iron pipes, laid in a bed of concrete. The ordinary construction of the duct consists of digging a trench of the desired size and covering the bottom, after it is carefully graded, with a layer of good concrete from 2 to 4 inches thick. Such a concrete may consist of Rosendale cement, sand, and broken stone in the ratio of 2:3:5, the broken stone to pass through a sieve of $1\frac{1}{2}$ -inch mesh. The sides of the trench are lined with $1\frac{1}{2}$ -inch planks. The first layer of pipes, consisting of wrought-iron pipes 3 to 4 inches in diameter, 20 feet long, and $\frac{1}{4}$ inch thick, joined by means of water-tight couplings, is laid on this concrete, and the space around

and above them filled with concrete. A second layer of pipes is laid over this, and so on. A covering of concrete 2 to 3 inches thick is placed over the last layer, and a layer of 2-inch plank is placed over all, to protect against injury by workmen. Fig. 46 shows a cross-section of such duct construction. The pipe should be reamed so as to remove any internal burs which might injure the insulation during the process of drawing in.

A modification of this system consists of the use of *cement-lined wrought-iron pipes*, of 8-foot lengths made of riveted sheet-iron pipes. Rosendale cement is used for the lining, which is about $\frac{5}{8}$ inch thick. The external diameter of the pipe is about $4\frac{1}{2}$ inches. The outside of the pipe is coated with tar to prevent rusting. The

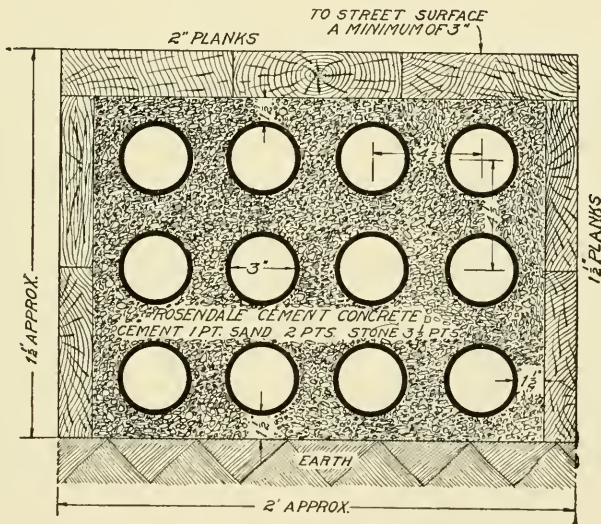

Fig. 46. Cross-Section of Wrought-Iron Pipe Conduit

sections have a very smooth interior and are light enough to be easily handled. They are embedded in concrete, similar to the system previously described. Connections between the sections are made by means of joints, constructed on the ball-and-socket principle, moulded in the cement at the ends of the sections. This forms a cheaper construction than the use of full-weight pipe.

Earthenware. This form of conduit is being extensively used for underground cables. The sections may be of either the single-

duct or multiple-duct type. The former consists of an earthenware pipe from 18 to 24 inches in length with internal diameter from $2\frac{1}{2}$ to 3 inches. These are laid on a bed of concrete, the separate tiles being laid up in concrete in such a manner as to break joints between the various ducts. In the multiple-duct system the joints are wrapped with burlap and the whole embedded in concrete. This form of conduit has a smooth interior and the cables are readily drawn in and out. The single-duct type lends itself admirably to slight changes of direction that may be necessary. Fig. 47 shows both forms of duct, while Fig. 48 shows a cement-lined iron-pipe duct system, laid in concrete, in course of construction.

Other forms of conduits are ducts formed in concrete, earthenware troughs, cast-iron troughs, cement pipe, and fiber tubes,

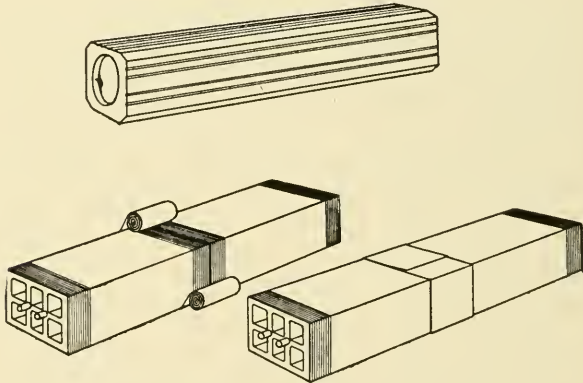

Fig. 47. Single- and Multiple-Duct Tile Conduits

Manholes. For all drawing-in systems, it is necessary to provide some means of making connections between the several lengths of cable after they are drawn in, as well as for attaching feeders. Since the cables cannot be handled in lengths greater than about 500 feet, and less than this in many cases, vaults or junction boxes must be placed at frequent intervals. Such vaults are known as splicing vaults or manholes. The size of the manhole depends upon the number of ducts in the system, as well as on the depth of the conduit. If the ducts be laid but a short distance from the surface of the street and traffic is light, the cables may readily be spliced with

a manhole but 4 feet square and 4 feet deep. The smaller vaults are often called handholes. Deeper vaults are from 5 to 6 feet square, and the floor should be at least 18 inches below the lowest ducts on account of convenience to the workmen and to serve as collecting basins for water which gets into the system. The ducts should always be laid with a gentle slope toward such manholes.

Common construction consists of a brick wall laid upon a concrete floor, the brick being laid in cement and being coated internally with cement. The cables follow the sides of the manhole and they are supported on hooks set in the brickwork. This causes

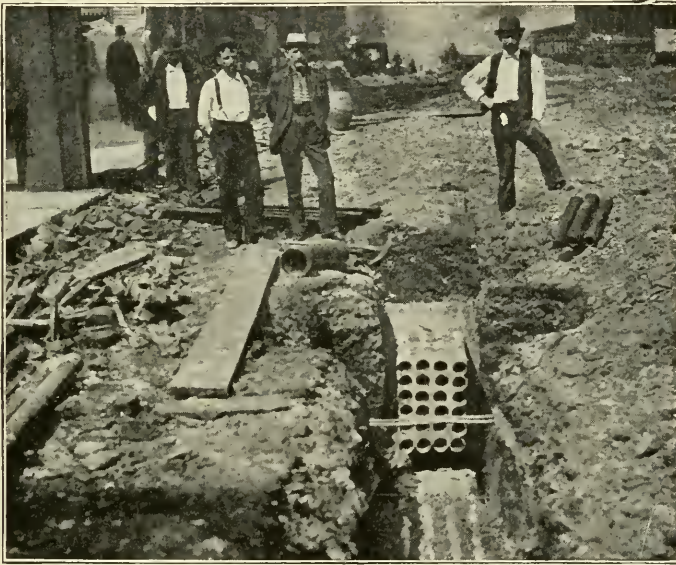

Fig. 48. Cement-Lined, Iron-Pipe Duct System in Course of Construction

quite a waste of cable in large manholes. Care should be taken that workmen do not use the cables, so supported, as ladders in entering and leaving the manhole, as the lead sheathing may readily be injured when the cables are so used.

Conductors are drawn into place by the aid of some form of windlass. Special jointed rods, 3 to 4 feet long, may be used for making the first connection between manholes or a steel wire or tape may be pushed through. A rope is drawn into the duct and the

cable is attached to this rope. Fig. 49 shows one way in which the cable may be attached to the rope. Care must be taken to see that no sharp bends are made in the cable during this process. Cable should not be drawn in during extremely cold weather unless some means is employed for keeping it warm, owing to the liability of the insulation to be injured by cracking.

Conduit systems must be ventilated in order to prevent explosion due to the collecting of explosive mixtures of gas. Many special ventilating schemes have been tried, but the majority of systems depend for their ventilation on holes in the manhole covers. This prevents excessive amounts of gas from collecting but does not always free the system from gas so completely as to make it

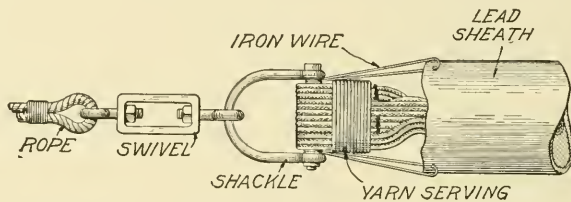

Fig. 49. Tackle for Fastening Cable to Rope to Draw Cable Through Ducts

safe for workmen to enter the splicing vault until the impure air has been pumped out.

Auxiliary ducts are laid over the main ducts and distribution is accomplished from handholes.

It is customary to ground the lead sheaths of the cables at frequent intervals, thus in no way depending on the ducts, even when made of insulating material, for insulation.

Cables. Well-insulated copper cables are used for underground systems. On account of the fact that various materials, such as acids and oils which are injurious to the insulation, come in contact with the cable, it is necessary that it be protected in some manner. A lead sheath is employed for this purpose. This sheath is made continuous for the whole length of the conductor, and with its use it is possible to employ insulating materials such as paper which, on account of being readily saturated by moisture, could not be used at all without such a hermetically sealed sheath. Lead containing a small percentage of tin is usually employed for

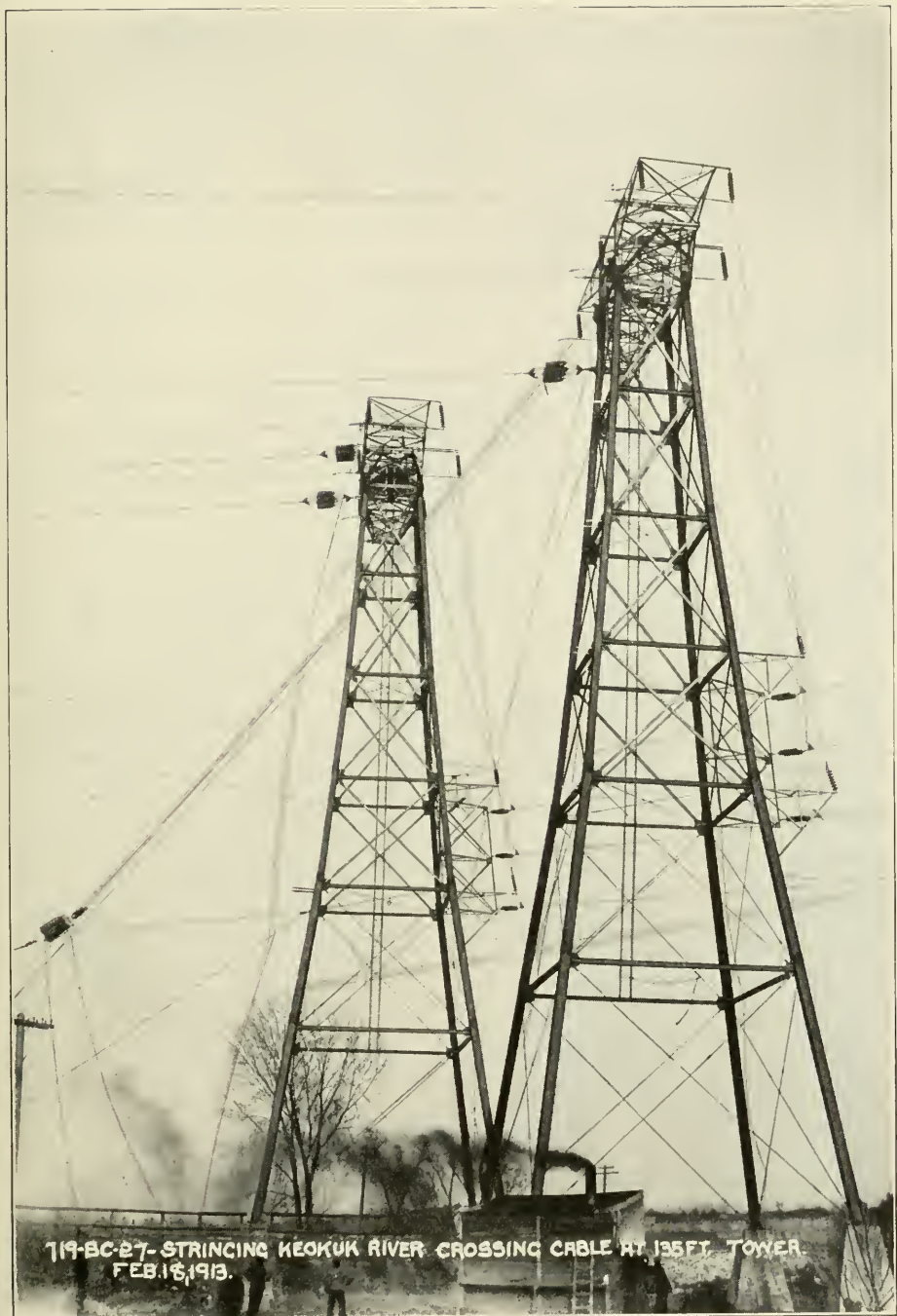

719-BC-27-STRINGING KEOKUK RIVER CROSSING CABLE AT 135 FT. TOWER
FEB 16, 1913.

SPECIAL 135-FOOT TOWERS USED FOR MISSISSIPPI RIVER CROSSING AT
HAMILTON, ILLINOIS, IN CONNECTION WITH THE MISSISSIPPI
POWER DAM AT KEOKUK, IOWA

Courtesy of Mississippi River Power Company

this purpose. The sheath may consist of a lead pipe into which the cable is drawn, after which the whole is drawn through suitable dies, bringing the lead in close contact with the insulation, or the casing may be formed by means of a hydraulic press.

Yarns thoroughly dried and then saturated with such materials as paraffin, asphaltum, rosin, etc., paper, both dry and saturated, rubber, and varnished cambric are the materials generally employed for insulation. When paper is employed, it is wound on in strips, the cable being passed through a die after each layer is applied, after which it is dried at a temperature of 200° F. in order to expel moisture. After being immersed in a bath of the saturating compound it is taken to the hydraulic presses where the lead sheath is put on.

Varnished cambric insulation consists of strips of varnished cloth treated with insulating varnish and applied much the same as paper insulation.

Where the cable is not exposed to moisture, as in a great deal of power plant wiring, no lead sheath is needed with varnished cambric insulation but the lead sheath is required for underground conduit work.

When rubber insulation is used, the conductors are tinned to prevent the action of any uncombined sulphur which may be present in the vulcanized rubber. The Hooper process consists of using a layer of pure rubber next to the conductors and using the vulcanized rubber outside of this. One or two layers of pure rubber tape are put on spirally, the spiral being reversed for each layer. Rubber compound in two or more layers is applied over this in the form of two strips which pass between rollers which fold these strips around the core and press the edges together. Prepared rubber tape is applied over this, after which the insulator is vulcanized and the cable tested. If satisfactory the external protection is applied.

Cable for polyphase work is made up of three conductors in one sheath. Fig. 50 shows a cross-section of cable manufactured for

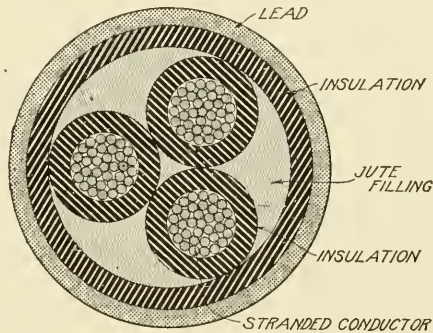

Fig. 50. Section of Polyphase Cable

TABLE X
Typical Cable Construction

Cables	No. of Conductors	Character of Conductor	Sizes of Individual Wires		
Electric light less than 500 volts.....	Single	Stranded	No. 10 B. & S. or smaller		
Arc lighting.....	Single	Solid	No. 6 or 4 B. & S.		
High-tension power transmission.....	Single, concentric, duplex, or three conductors	Stranded	No. 10 B. & S. or smaller		
Thickness of Insulation					
	Rubber	Saturated Fiber	Saturated Paper	Dry Paper	Thickness of Lead
	Inch.	Inch.	Inch.	Inch.	Inch.
Electric light less than 500 volts.....	$\frac{3}{32}$	$\frac{5}{32}$	$\frac{5}{32}$	$\frac{5}{32}$	$\frac{1}{16}$ to $\frac{1}{10}$
Arc lighting.....	$\frac{5}{32}$ to $\frac{8}{32}$	$\frac{8}{32}$	$\frac{8}{32}$	$\frac{8}{32}$	$\frac{1}{16}$
High-tension power transmission.....	$\frac{5}{32}$ to $\frac{8}{32}$	$\frac{8}{32}$	$\frac{8}{32}$	$\frac{8}{32}$	$\frac{1}{10}$

three-phase transmission at 6,600 volts. The conductors of this cable have a cross-section equivalent to a No. 0000 wire, to which an insulation of rubber $\frac{3}{32}$ inch thick is applied. These three conductors are twisted together with a lay of about 20 inches. Jute is used as a filler, and a second layer of rubber insulation $\frac{4}{32}$ inch thick is then applied. The lead sheath employed is $\frac{1}{8}$ inch thick, and is alloyed with 3 per cent of tin.

Joints in cables must be carefully made. Well-trained men only should be employed. The insulation applied to the joint should be equivalent to the insulation of the cable at other points, and the joint as a whole must be protected by a lead sheath made continuous with the main covering by means of plumbers' joints.

Some engineers prefer rubber, some prefer paper or varnished cambric insulation, but all types are giving good service, and are used up to voltages of 22,000. It is customary to subject each cable to twice its normal potential soon after it is installed. This voltage should not be applied or removed too suddenly, as unnecessary strains might be produced in this manner.

Rubber-insulated cables should never be allowed to reach a temperature exceeding 65° to 70° C. (149° to 158° F.). Paper will stand a temperature of 90° C. (194° F.), but it is neither desirable nor economical to allow such a temperature to be reached. Varnished cambric insulation can be run at a temperature of 100° C. without injury. It is less expensive than rubber, but costs more than paper. Table X is of interest in connection with underground cables. The dimensions here given are only general.

MISCELLANEOUS FACTORS

Selection of Voltage. The voltage to be selected for a given system depends on the distance the power is to be transmitted as well as its amount, and on the use to be made of the power. If a lighting load is concentrated in a small district, a 220-volt three-wire system will give very good service. If the region is a little more extended, possibly a 440-volt three-wire system using 220-volt lamps would serve the purpose without an excessive loss of power or a prohibitive outlay for copper. For location when the service is scattered, a distribution at from 2,200 to 4,000 volts alternating current is used, transformers being located as required for stepping down the voltage for the units which may be fed from a two- or three-wire secondary system.

2,300 volts (alternating) is a standard voltage for lighting purposes and for polyphase systems; 2,300 volts is often taken as the voltage between the outside wires and the neutral wire of a four-wire three-phase distribution.

For railway work, 550 to 600 volts direct current is used up to distances of about 5 or 6 miles, beyond which it becomes more economical to install an alternating-current main station and supply the line at intervals from substations to which the power is transmitted at voltages of from 6,600 to 30,000 or even higher, depending on the distance it is to be transmitted. At present, the highest voltage used in long-distance transmission is 110,000, and even higher values are contemplated. Such voltages are used only on very long lines, and each one becomes a special problem. It is always well to select a voltage for apparatus which may be considered as standard by manufacturing companies, as standard apparatus may always be purchased more cheaply and furnished in

shorter time than special machinery. The following voltages are now considered standard for transmission purposes: 6,600, 11,000, 22,000, 33,000, 44,000, 66,000, 88,000, and 110,000.

Line Protection. Lightning arresters are installed at intervals along overhead lines for the protection of connected apparatus. For ordinary lighting circuits, such arresters are installed for the protection of transformers, and are located preferably on the first pole away from the one on which the transformer is installed. Care should be taken to see that there are no sharp bends or turns in the ground wire and that there is a good ground connection. For the high-tension lines, lightning arresters at either end of the circuit are relied on to afford the greater part of the protection. In some localities, a wire strung on the same pole line at a short distance from the power wires and grounded at very frequent intervals has been found to reduce troubles due to lightning.

The grounding of the neutral of three-wire secondary systems forms a means of protection of such circuits against high potentials which might arise from accidental contact with the primaries, and is recommended in some cases. The grounding of the neutral of high-tension systems reduces the potential between the lines and the ground, but a single ground will cause a short-circuit on the line with any grounded system. Grounding, through a resistance which will limit the flow of current in such a short-circuit, has been recommended and is employed in some instances. Spark arresters are installed at the ends of high-tension underground systems to prevent high voltages which might injure the insulation in case of sudden changes in load, grounds, and short-circuits.

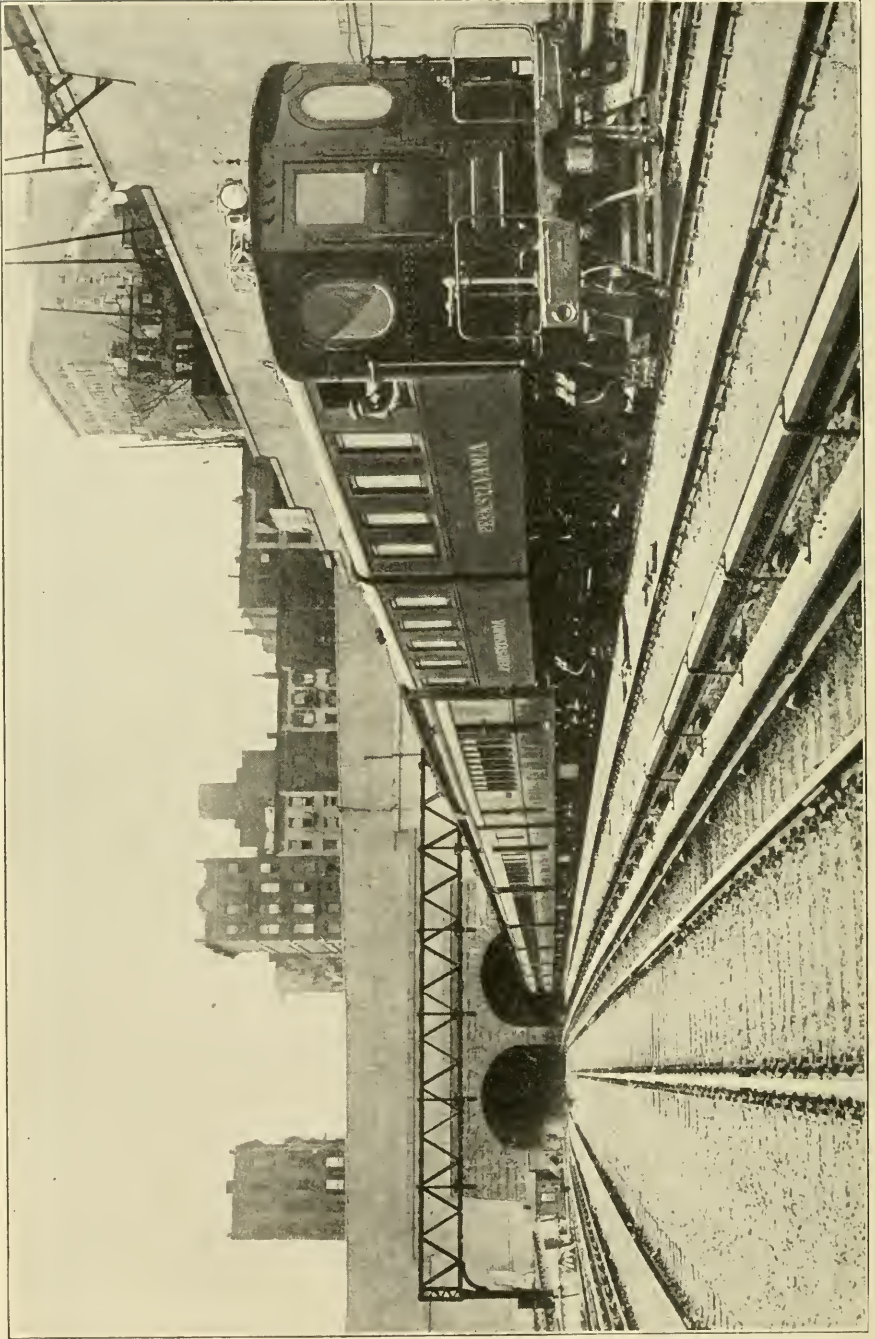

PENNSYLVANIA LOCOMOTIVE DRAWING HEAVY PULLMAN PASSENGER TRAIN OUT OF THE NEW YORK TERMINAL
Courtesy of Westinghouse Electric and Manufacturing Company

ELECTRIC RAILWAYS

PART I

INTRODUCTION

Before a student can appreciate the purposes of the different parts of an electric railway system, he must know what the primary purpose of such a system is, as the details of selection and operation of equipment must have a direct bearing upon this purpose. Let us start, therefore, with the following important statement, which we shall try to keep in mind throughout the course:

The purpose of a railway system is to transport paying load between points at minimum total cost with maximum safety.

Railways are termed in law "common carriers," and as such they enjoy privileges not common to other lines of business, such as the use of streets and roads, and are more or less of a monopoly in their territory. For this reason they are subject to the control of the public to a greater extent and this fact affects the engineering problems and the details of equipment. For example, the state commissions which control railway operation and equipment—subject, of course, to the jurisdiction of the courts—may specify details of equipment which the companies might not choose on the basis of economy, which fact must be kept in mind in connection with the previous important statement.

We must not confuse the two electric railway problems, viz, that of the street and the interurban transportation, with that of heavy electric railroading. The latter, although very important, does not affect the average man engaged in electric railway work. It is largely a matter of replacing steam with electric locomotives. We shall devote some attention to this after finishing what is, for our purpose, more important material.

Engineering Features. From the engineering standpoint, the problems of railway operation are largely problems of mechanics. A

car loaded with passengers or freight is simply a mass which has to be (a) brought from rest up to speed; (b) maintained at speed for a while; and (c) brought to rest again. That is all there is to the mechanical problem, but this series of three operations involves a vast amount of detail in electric railway practice. The present study is designed to familiarize the student with this detail as systematically and simply as possible. He will be assisted in his study by noting the divisions of a modern railway system upon which the course is based, viz,

- (1) Rolling stock, including equipment
- (2) Motive power (power houses and substations)
- (3) Maintenance of way (track)
- (4) Transmission
- (5) Transportation (time-tables and crews)
- (6) Administration and business

These departments may or may not include the necessary engineering and construction forces necessary to build, to renew, or to extend the plant. The course will consist in descriptions of the equipment necessary or desirable in these several departments, and of the principal practical and theoretical features involved. While the general order given is followed in the course, the major portion of the space has been allotted to the first division. The student is already partly familiar with the railway power station from his earlier studies.

ROLLING STOCK AND EQUIPMENT

Historical. Before describing the apparatus it may be well to call attention to the history of the development of the modern car which has come, through a process of evolution, to perform its functions so perfectly. It has always been the case that every new form of motive power has been applied first, or at least very early, to transportation. The reason for this is that transportation furnishes the largest single field for the application of power. As soon, therefore, as the electric motor gave promise of commercial success, even when current had to be obtained from primary batteries, experiments were begun with a view to producing electric cars. In 1834, Thomas Davenport, a blacksmith of Brandon, Vermont, made a small model

of an electric car. This was, of course, driven by primary batteries, for a satisfactory form of the electric generator or "dynamo" was not produced until many years later. Davenport made his own motors, which consisted of permanent magnets and electromagnets, and these, by their attraction, produced the torque. One of the successful motors of this time was that of a Russian, M. H. Jacobi. His motor was applied to a car by Robert Davidson of Aberdeen, Scotland, about 1838. An idea of the principle of this motor can be obtained from Fig. 1, which shows a motor used by Jacobi in a boat on the River Neva, Russia, about this time. There are two sets of horseshoe electromagnets held in stationary frames facing each other and with a space in between.

These are the field magnets. Between them is the revolving armature consisting of bar electromagnets, one bridging across each pair of opposite field poles. Current flows to the armature through collectors and brushes by means of which the current is applied intermittently. The magnets give a series of jerks upon the armature and thus keep it revolving.

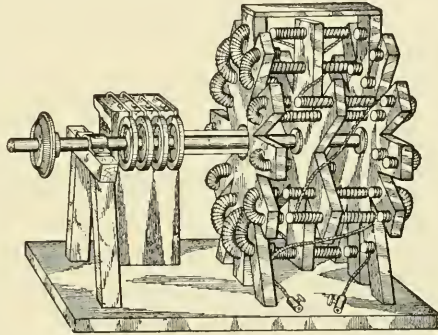

Fig. 1. Early Jacobi Motor Used on Boat in Russia

While this motor produced considerable power, it was not efficient.

In this country, in 1847, Prof. Moses G. Farmer made a car with a motor which looked like a "Ferris wheel," only that instead of the cars were iron armatures which were attracted by electromagnets. The principle was not substantially different from that of Jacobi's motor. It is not necessary to mention all of the early attempts at electric traction, for until a good source of electric power was devised, all of these attempts were commercial failures.

It was in 1879, at the exposition at Berlin, Germany, that a successful car was shown and operated, drawing a number of trailers filled with passengers. The car was simply a Siemens motor laid on its side on a little truck and geared to the wheels. Current was taken in from the rails. The firm of Siemens and Halske, now so well known in the electrical business, put a regular car into oper-

ation in the suburbs of Berlin in 1881. In this country, from 1880 to 1885, there were many experimenters trying to make electric cars, particularly locomotives. The *names of Stephen D. Field, Thomas A. Edison, Frank J. Sprague, Charles J. Van de Poele, Leo Daft, Sydney H. Short, and others should be familiar to every student of electric traction. Finally in 1887, the first large equipment of electric traction in this country was installed by F. J. Sprague in Richmond, Virginia, and within a few years the horse, cable, and steam cars disappeared from the streets.

The essential parts of a car are the car body and trucks; the motors and controlling apparatus necessary in starting the car and keeping it going; the braking apparatus for bringing it to rest; and sundry current-collecting, protective, heating, and other secondary equipment.

CAR BODY

While a car is essentially *a box on wheels*, the building of successful cars is an art requiring special preparation and experience. An electric car must be (1) *strong*, so that it can stand the strains incident to starting and stopping, to irregularities in the track, to rounding curves, to collisions, to carrying heavy loads, etc.; (2) *light*, so that no unnecessary "dead weight" need be hauled around; (3) *accessible*, so that passengers may get on and off quickly and safely; (4) *convenient*, so that the comfort of the passengers is well cared for in regard to seating, warmth, ventilation, and lighting; and (5) *attractive in appearance*, so that the cars will please the public and attract business.

The car body is, roughly, a rectangular box, carefully stiffened and braced. A curved monitor-deck roof allows for ventilation and improves appearance. Platforms and vestibules are attached at the ends to provide entrance and exit for passengers and accommodations for the crew and the controlling apparatus. The important divisions of the body are (a) the under-frame and the floor, (b) the sides and the ends, (c) the roof, and (d) the platforms and the vestibules.

Frame. The under-frame is the foundation of the body and its design and construction are, therefore, of prime importance. It consists of side, center, intermediate, cross, and end sills, with

*The student is advised to look up these names in any good biographical dictionary or encyclopedia.

bracing. These are clearly shown in Figs. 2 and 3, which represent a double-truck interurban car in elevation, plan, and section. The side, center, and end sills are designed for strength and stiffness. They may be of wood or steel or both. In Fig. 3, the right-hand half of the car is in cross-section. One of the center sills is shown with a steel I-beam 6 inches deep at the center and with yellow

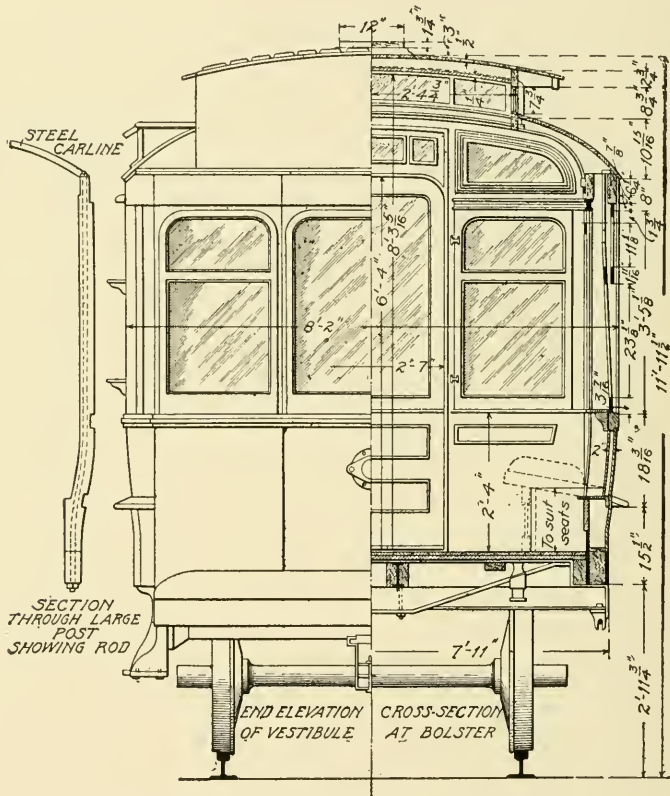

Fig. 3. End View and Cross-Section of Interurban Car

pine or oak filling, bolted securely on both sides. The side sills, in this case, have wood sides with a steel plate between and an extra steel plate on the outside. The intermediate sills, parallel with the side and center sills, are of less importance, being merely floor supports, hence they are made of wood of smaller dimensions. The end sills are usually of oak, bolted securely to the ends of the

longitudinal sills, and forming with them a strong rectangular frame. A number of cross sills, also of oak, are used to maintain uniform spacing of the longitudinal sills, to stiffen the frame, and to support the floor. At each cross sill, a level rod passes from side to side of the floor, permitting it to be drawn firmly upon the cross sill.

Double-Truck. The double-truck car body is supported by means of "bolsters" at two points, viz, the truck centers. The bolsters are usually wide steel plates, located crosswise of the body, and in cross-section about 9 or 10 inches by $\frac{7}{8}$ inch, bent as shown in Fig. 3. In the car illustrated, each bolster is made up of two narrower plates separated about 1 foot. The bolsters are attached firmly to the side sills and they are braced with iron or wood blocks. At the middle of each bolster is attached a bearing plate, which rests upon a corresponding plate on the bolster of the truck. The

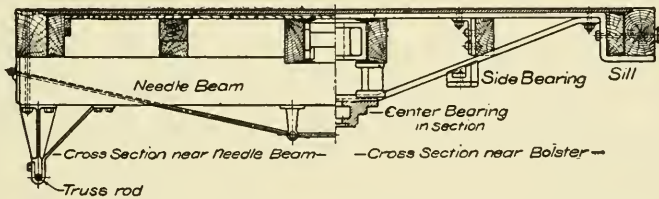

Fig. 4. Cross-Section of Underframe Showing Needle-Beam and Bolster

car body bolster also carries side bearings, which rub upon corresponding bearings on the truck bolster and prevent tipping of the car body. Study Fig. 4.

Single-Truck. Single-truck car bodies do not in general need longitudinal truss rods as they are supported along nearly their entire length by the truck frame. Double-truck cars must have ample trussing. The elevation in Fig. 2 shows a truss rod under the side sill, passing apparently from bolster to bolster, and bolted firmly to the sills near the bolsters. It is stretched over two "needle-beams," which are iron or wooden beams bridging from side sill to side sill, with saddles over which the truss rods pass. The needle-beams transmit the supporting force of the truss rods to the sills and prevent the latter from sagging in the middle. Turn-buckles are provided at the middle of each truss rod to permit an increase of tension and to correspondingly increase the supporting force.

In addition to the underneath truss rods, inside truss rods are usually mortised into the side posts and are covered up by the sheathing. The inside truss rods, which are placed as high on the posts as the window framing will permit, pass from end sill to end sill. These rods support the ends of the floor framing, whereas the underneath rods support the middle.

The floor framing is covered with a double floor, usually of quarter-sawed yellow pine, the lower thickness being laid crosswise of the car, and the upper thickness, lengthwise. The two thicknesses are separated by roofing felt. The floor boards are thoroughly painted all over. In the floor, trap-doors are provided, over the

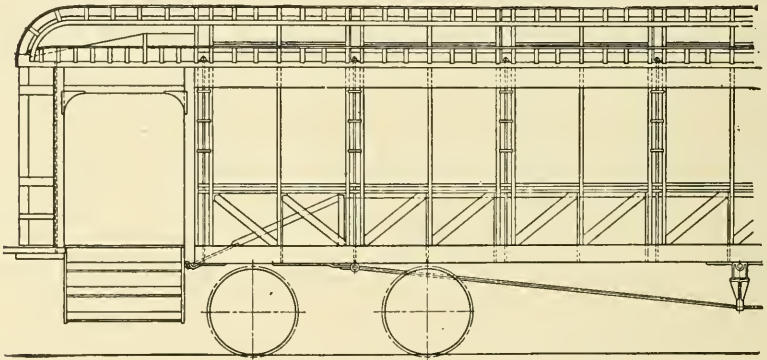

Fig. 5. Side View of Car Framing

motors, so that they can readily be reached from the inside for inspection and adjustment of brushes.

EXERCISE. The student should at this point, sketch from memory an underframing plan, labeling each part carefully.

Sides and Ends. The sides and ends of the car body are supported by posts of tough ash. The form of the side post is shown at the left in Fig. 3, and in section at the left in Fig. 2. In cars having ordinary single windows, all of the side posts are alike. In cars with Pullman windows, as in Fig. 2, alternate posts, which come in the middle of the top sash, are made lighter and are cut away to clear the top sash on the inside. The corner posts are constructed of the same general pattern and materials as the side posts but they are much heavier. The general arrangement of the posts and sills is shown in Fig. 5, which gives the appearance of a car body before

the sheathing is applied. A general perspective view of a body is given in Fig. 6.

The posts are connected by horizontal ash strips, known as "rails," *e.g.*, top rail and belt rail. The post is "gained" or notched out to fit the latter, which is located just under the window frames. Half-way between this and the floor is the drip rail. Under the windows, between the posts, is diagonal bracing of ash, which insures against racking of the body, fore and aft. In order to bind

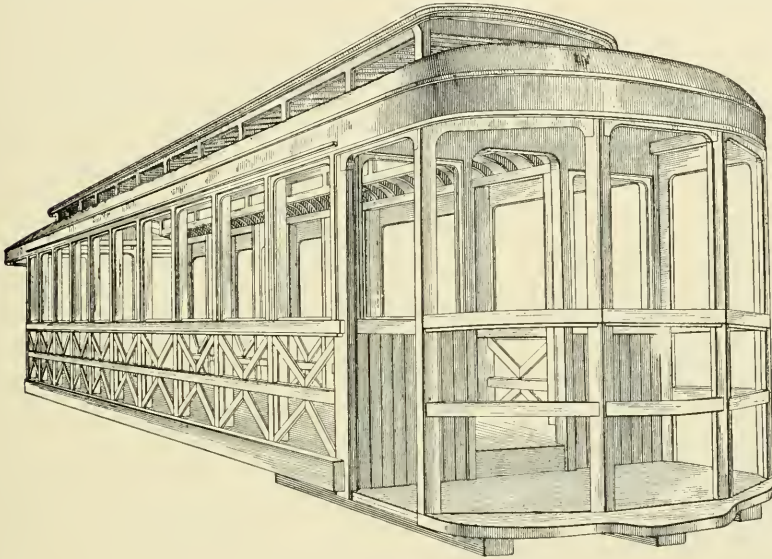

Fig. 6. Perspective View of Car Framing

the side posts firmly to the sill, a light bolt, say $\frac{1}{2}$ inch in diameter, is in many cases run from top to bottom, Fig. 3, through the sill and the top rail. Another method of attaching the side post to the sill often employed is where a bolt passes through the sill and above is flattened out into a narrow plate which is secured to the side of the post. The upper end is bent over at right angles to fit into a notch cut into the post. This takes the strain off the screws.

The sides and the ends of the car, inside and out, are covered with sheathing of matched soft wood if it is to be painted, or hard wood where natural finish is called for. On the inside of the outer sheathing a coating of linen scrim is sometimes glued and painted to insure air tightness.

Roof. The standard car roof is of the monitor-deck pattern shown in Fig. 3, although there is a tendency to do away with this type and use a simpler roof. The roof consists of upper and lower decks supported upon wood and steel carlines. The wood carlines which support the lower deck are curved pieces of ash which bridge from the top rail to the lower ventilator rail, being tenoned and glued into each. The ventilator mullions or uprights support the upper ventilator rails which are connected by the upper deck carlines, also of ash. The wood carlines, spaced about 10 inches between centers, are re-enforced by a number of steel carlines which bridge from top rail to top rail in one continuous piece bent to conform to the contour of the roof, and bolted to the sides of the wood carlines. The ends of the steel purlins are bent over to form feet which are bolted firmly to the top rails. The roof framing is covered with thin matched soft wood sheathing and painted. Over this is stretched heavy cotton duck which is heavily painted. In the

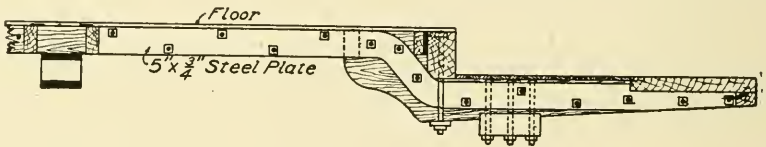
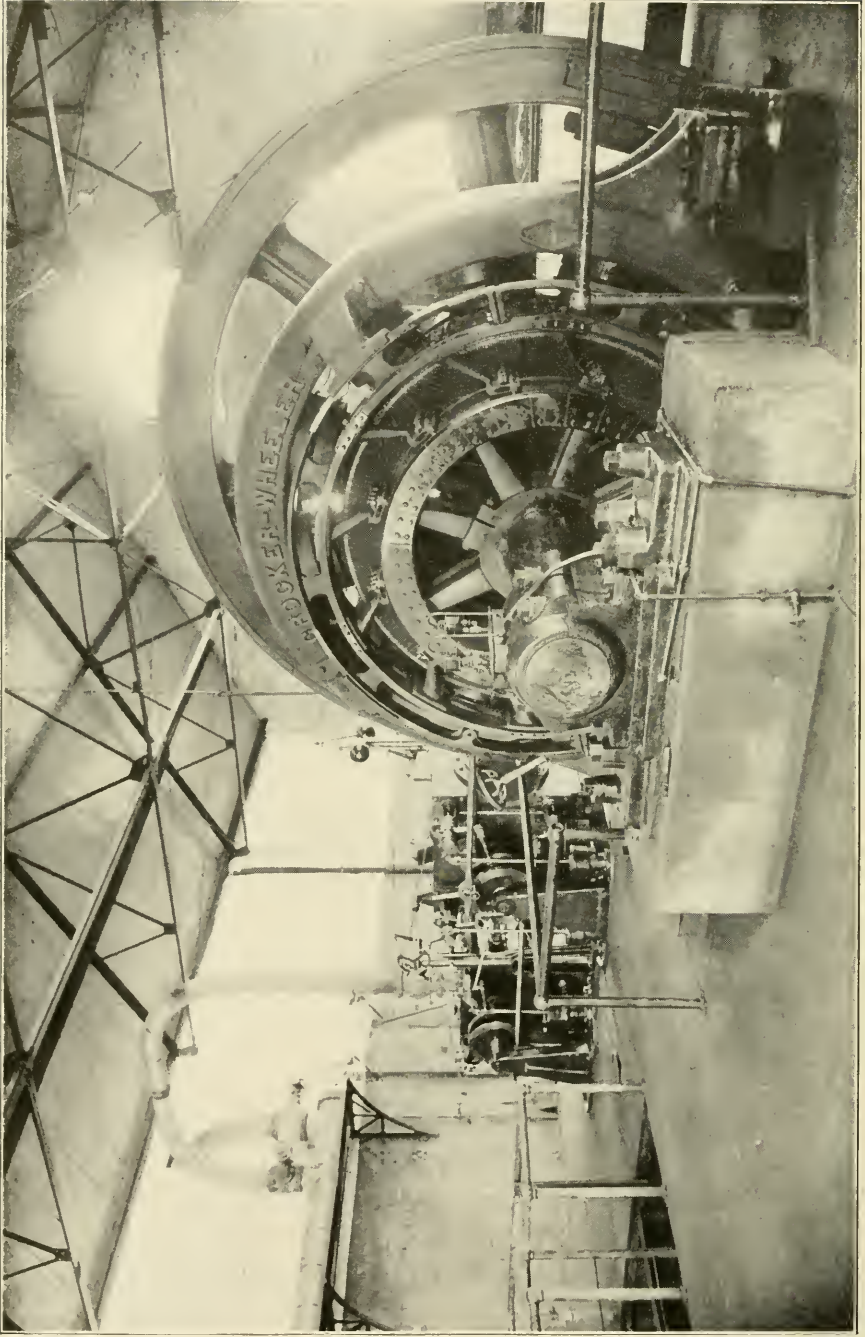

Fig. 7. Platform Knee

center of the roof is mounted on cleats a narrow trolley board, or boards, upon which the trolley stand is to be mounted. Roof mats of ash slats are frequently used to protect the upper deck of the roof from wear caused by the feet of repair men.

Vestibule. Platforms and vestibules form an increasingly important feature of car construction in view of the improvements recently introduced to insure safety to passengers, speed of loading and unloading, and reliability of fare collection. The platforms are in some cases a part of the floor framing and the sills are made longer, extending beyond the corner posts. In general, however, the body is complete without the platforms. In Fig. 3 the platform is supported by timbers or steel plates extending for several feet back along the sills and bolted securely to them. The outer ends of the platform floor supports are attached to the headblocks, curved to give the desired contour to the ends of the car. Additional



RAILWAY GENERATOR OF 600-VOLT, 400-KILOWATT CAPACITY INSTALLED FOR THE HAMPTON ROADS TRACTION COMPANY, HAMPTON, VIRGINIA
Courtesy of Crocker-Wheeler Company

strength is secured by means of steel re-enforcing plates, of the form shown in Fig. 7, which are also bolted to the sills. These are placed well in toward the car center line to allow the steps, Fig. 3, to be set practically inside the line of the body. The interurban car illustrated in Figs. 2 and 3 has short platforms. As long platforms are now almost universally used in cities, we shall devote a little attention to them.

The long platform is used principally in cars designed to let passengers on and off at the same time. Fig. 8 shows one plan,

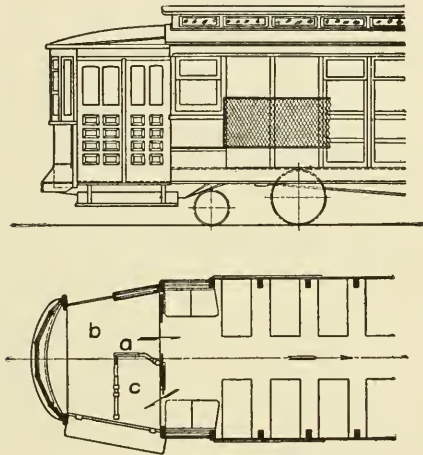

Fig. 8. Pay-as-you-enter Car

known as the "pay-as-you-enter". The rear platform in this plan is divided into two sections by the guide rail *a*; the larger section *b* is for entering passengers, the smaller section *c* being an exit passageway. Section *c* also furnishes a station for the conductor from which he can collect fares (as the passengers enter), operate the doors and the folding steps, and in general assist the passengers in boarding and leaving the car. This arrangement renders necessary the use of two rear doors in the car body, one for entrance, the other for exit. The front platform is intended as the main exit only and is provided with a narrow step for this purpose. The motorman is so located that he is out of the way of passengers leaving and at the same time he cannot be crowded by these passengers. The motorman is in a position to operate the exit door and the folding

step, if the latter is employed. The arrangement described is intended to facilitate (1) the movement of passengers with increase of safety to them, and (2) the collection of fares; and furthermore is such as to encourage the tendency of the passengers to move forward in the car in order to be near the main exit, which is on the front platform. A number of modifications of the "pay-as-you-enter" plan are in use, each being adapted to the particular kind of service required. There are also somewhat different schemes with the same general purpose. These have descriptive names, such as "pay-as-you-leave," "pay within," "pay-on-the-platform," etc.

Platform space is usually enclosed, forming comfortable vestibules for the protection of crews and entering and leaving passengers. The roof or "bonnet" of the vestibule, in some cases, follows the general lines of the car roof, as in Fig. 2. In most city cars it is simply a light wood, canvas-covered structure, as shown in Fig. 8. The sides and front of the vestibule are formed of wood panels, sash and doors.

TRUCKS

The bodies of electric railway cars are carried on trucks. Each truck has four wheels and there may be one or two trucks for a car. The cars may, therefore, be designed as "single-truck" or "double-truck" cars. The trucks for the two types of car are quite different in construction and they will be treated separately.

Single Trucks. *General Principles.* A typical truck for a short city car is shown in Fig. 9. In this truck there are two longitudinal steel strips A and B , upon which the car body rests and to which it is bolted. Each of these strips is supported upon two leaf springs S_1 and four coiled springs S_2 . The coiled springs take the main weight of the body, while the leaf springs support the ends of the body which "overhang" beyond the axles. Both coiled and leaf springs rest upon a forged side frame F , which is spring-supported, by means of the springs S_3 . These springs rest in the sockets of steps which project from the bottom of the journal boxes J . The journal boxes are cast-iron boxes which contain the bearings and afford space for the lubricant (grease or oil). Where the side frame passes over the journal boxes, it is arched so as to clear them. The sides of this arch form guides which work in grooves in the sides of the journal boxes. The frame

can, therefore, move up and down as the springs are compressed, but its motion in other directions is restrained. The journal boxes, carrying the weight of all of the parts so far described as well as that of the car body, rest upon the ends of the axles. The journals, the wearing parts of the axles, project beyond the wheels, which are pressed upon the axles.

In addition to the essential features mentioned, the truck illustrated in Fig. 9 contains several important details, which may be seen in the figure. The two side frames are held in the proper position by braces at the center and by the "pilot boards" *O* at the ends. The motor suspension bars *M* are spring-supported from the side frame. These bars are provided to carry a part of the weight of the motor, the balance of which is supported by the axles. The brake rigging, comprising shoes, hangers, rods,

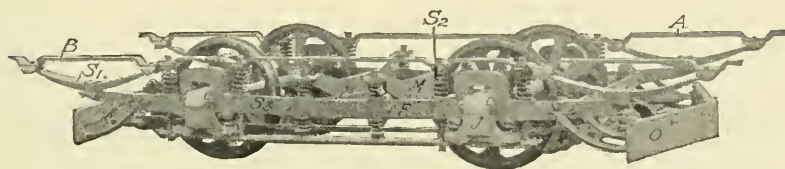

Fig. 9. Brill Single Truck

and levers, is carried by the truck. This is not shown clearly in the illustration and will, with the other details, be described separately.

The purpose of the rather elaborate spring support of the car body and truck frame is to provide comfortable riding for the passengers and durability for the car and track. When the wheels strike irregularities in the rails or obstructions upon them, the wheels are given a violent upward or downward motion. This motion is not communicated instantly and violently to the car body, which possesses inertia, but it is more or less absorbed by the springs. The car is thus relieved of the blow which it would otherwise receive and in turn the track is saved the reactive blow due to the mass of the car. The spring system is designed to prevent "teetering" of the body while giving as much flexibility as possible. Teetering, as the name indicates, is a backward and forward vibration of the body, which is started and maintained

by irregularities in the track. It is very trying to the passengers. The leaf springs S_1 tend to prevent this trouble.

Double Trucks. *General Principles.* A popular form of swivel truck for double-truck cars is shown in Fig. 10. This is known as the M. C. B. truck as it follows the lines recommended by the Master Car Builders' Association for steam railroad trucks. While other swivel trucks differ in important details they are similar to this in the essential principles. Swivel trucks are used on cars which have bodies too long for the single trucks. The swivel trucks have the advantage of a short wheel-base (distance between axle centers) which permits them to pass easily around the sharp curves used in many cities.

Fig. 10 can be understood by comparing it with Fig. 9. The truck consists of a rectangular steel frame, spring-supported from the

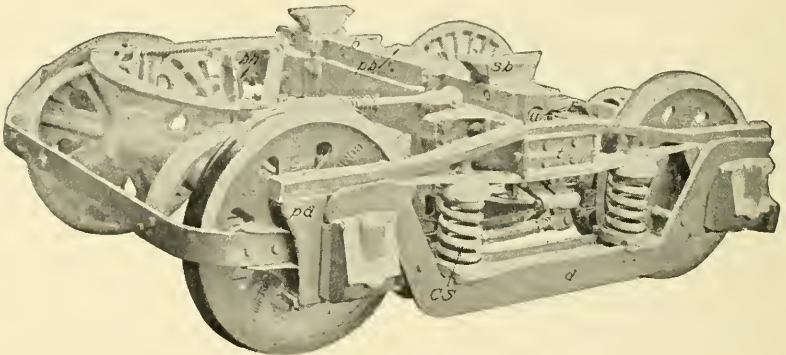

Fig. 10. Light M. C. B. Truck

journal boxes, but the car body is not supported upon this frame but upon the pivot plate pb . The truck turns or "swivels" upon this plate, upon which rests the bearing plate of the car bolster, described on page 7. A kingbolt passes through holes in the center of the pivot and bearing plates to obviate the danger of the pivot plate becoming unseated. The pivot plates form the main supports of the car body, which is balanced sidewise upon them when the weight is evenly distributed. The pivot plate is mounted upon the bolster, which also carries the side bearings sb . These bearings prevent tipping of the car when the weight is unbalanced, in which case they rub on the side bearings of the car-body bolster. The relative

positions of the car-body and truck bolsters, and the center and the side bearings, as well as other important details, are shown in Fig. 12.

In order to secure the greatest possible elasticity of car body support, a double spring system is used in the M. C. B. truck.

First, the truck bolster is carried upon a "spring plank," Fig. 11, through elliptical leaf springs *SS*. Fig. 12 shows the bolster,

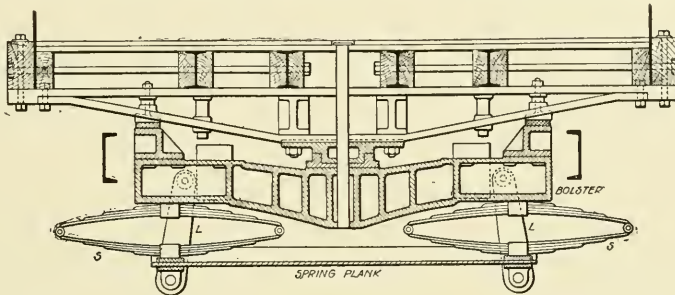

Fig. 11. Section of Bolster, Elliptical Springs and Spring Plank

spring plank, and elliptical springs in more detail. The spring plank hangs from the "transom," by links *LL*, Fig. 11, which allows a slight swing sidewise. The transom consists of two steel plates, separated by enough space to accommodate the bolster and with enough clearance to permit the bolster to move up and down as the elliptical springs are compressed or released. The transom is rigidly attached to the frame.

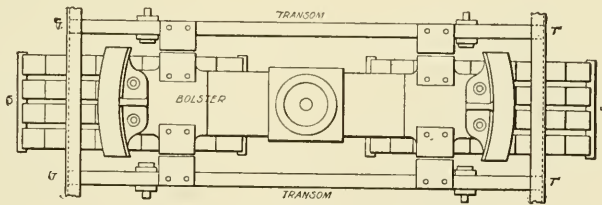

Fig. 12. Plan of Bolster and Spring Plank

Second, the main frame is spring-supported through the coiled springs *CS*, Fig. 10, upon the side bars *d*, which in turn are carried by the journal boxes.

In order to preserve the proper alignment of the journal boxes and truck frame, the latter carries downward-projecting castings, as shown at *pd*, which form guides for the journal boxes. The latter,

as in single trucks, are grooved on the sides to fit the above mentioned castings. These castings form the "pedestal."

Before leaving Fig. 10, attention is called (1) to the small springs *E* on the ends of the bolster, which prevent it from striking violently against the truck frame; (2) to the brake hanger *bh* which supports the brake shoe; and (3) to the pilot board which is intended to remove obstructions from the track.

A heavier type of M. C. B. truck is shown in Fig. 13. This truck is equipped with steel-tired wheels, stronger springs, and heavier frame, but the essentials are exactly the same as in the preceding case.

A *short wheel-base truck* of somewhat different construction is

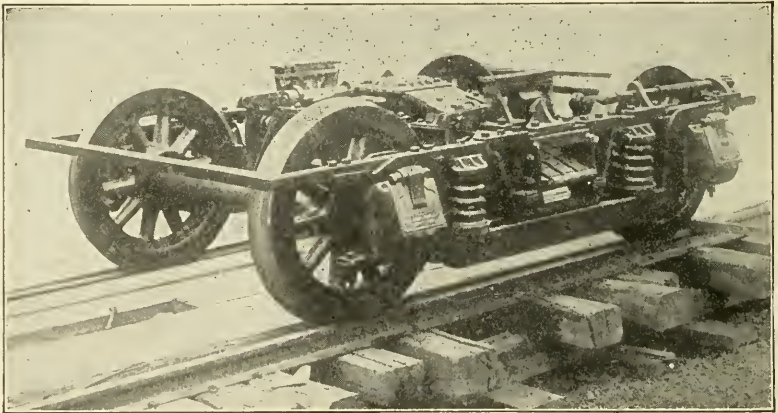

Fig. 13. Heavy M. C. B. Truck

illustrated in Fig. 14. It is necessary to have a short wheel base, or distance between axle centers, when the truck has to round curves of short radius. In such a truck there is not room for the motors between the axles and consequently the motors must be turned around with their spring suspensions on the outside. Motors so mounted are "outside hung" as contrasted with the others which are, therefore, "inside hung." The short wheel-base truck shown in the figure has some other features which are different from the other trucks described. The side bar is a steel casting which is very simple in construction. The spring support is also much simpler than in the M. C. B. truck, although it is a less easy-riding

support. On the top of each journal box is a coiled spring which rests in a socket cast for the purpose. This arrangement will be shown in detail in the drawings of the journal box which will be taken

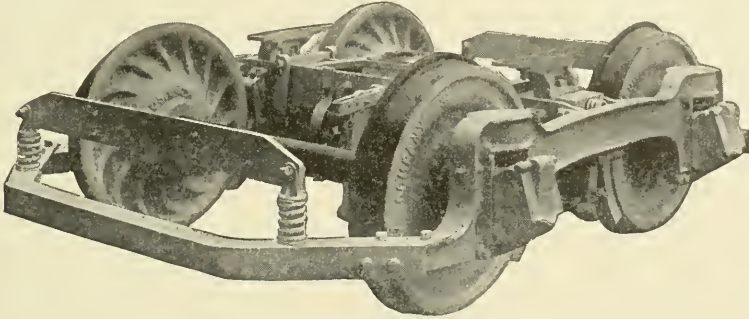

Fig. 14. Short Wheel-Base Truck

up later. The side bar expands into a socket at the top to receive the coiled spring. The bolster is supported on elliptical springs carried by the spring plank as in the other trucks described.

The *maximum traction truck* is a special form of truck used when two motors are to be used on a double-truck car. If but one motor is mounted on a standard truck, but one-half of the weight of the car is available for producing adhesion between the wheels and the track when the car is being driven by the motors. In the

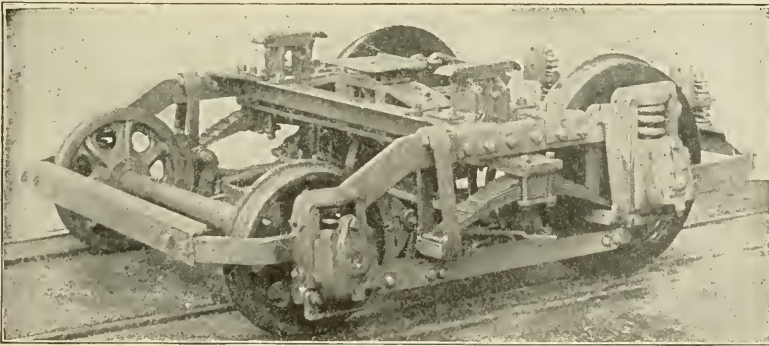
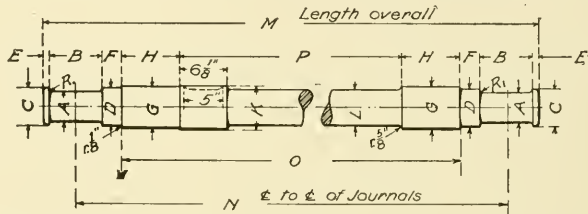

Fig. 15. Maximum Traction Truck

maximum traction truck the center of support is shifted from the center to a point as nearly over the motor axle as possible, as shown in Fig. 15. The two pairs of wheels are of different diameters,

the driving wheels being of as large diameter as the room under the body permits. The others are pony wheels which follow the curvature of the track with great precision. The motor is "outside hung" from the main axle as in the case of the short wheel-base truck. In the type of truck shown in the figure, the bolster is mounted on leaf springs hung from the side bar by links, this being necessary in order to allow space for the brake rigging between the wheels. The essential features of the maximum traction truck are the same as in those described earlier. In the side elevation of a car body in Fig. 8, the wheels of a maximum traction truck are shown.

Truck Details. The forms and dimensions of a number of the component parts of trucks are becoming standardized through the



Journal		C	D	E	F	G	H	K	L	M	N	O	P	R	R ₁	Max Capacity	Horse Power
A	B																
3 ³ / ₄	7	4 ³ / ₄	4 ³ / ₄	5 ⁵ / ₈	2 1/2	5 ⁷ / ₁₆	7 1/2	5 1/2	4 1/2	83 ¹ / ₄	75	63	48	1/4	1/4	15,000 lbs	45
4 ¹ / ₄	8	5 ¹ / ₄	5 ¹ / ₄	5 ⁵ / ₈	2	5 ¹⁵ / ₁₆	7 1/2	6	5	84 ¹ / ₂	75	63	48	1/4	5/8	19,000 "	45-65
4 ¹ / ₄	8	5 ¹ / ₄	5 ¹ / ₄	5 ⁵ / ₈	2	5 ¹⁵ / ₁₆	7 1/2	6	5	84 ¹ / ₂	75	63	48	1/4	5/8	22,000 "	65-100
5	9	6 ¹ / ₈	6 ¹ / ₈	5 ³ / ₄	2	6 ¹⁵ / ₁₆	6 1/2	7	6	86 ¹ / ₂	76	63	50	1/8	3/4	27,000 "	100-150
5	9	6 ¹ / ₈	6 ¹ / ₈	5 ³ / ₄	2	6 ¹⁵ / ₁₆	6 1/2	7	6	86 ¹ / ₂	76	63	50	1/8	3/4	31,000 "	150-200
5 ¹ / ₂	10	6 ⁵ / ₈	6 ⁵ / ₈	5 ³ / ₄	2	7 ¹⁵ / ₁₆	6 1/2	8	7	88 ¹ / ₂	77	63	50	1/8	3/4	38,000 "	200-250

Fig. 16. American Electric Railway Engineering Association Standard Axles

co-operation of the American Electric Railway Engineering Association, the manufacturers, and the electric railway operators. The standards adopted by the Railway Association may be considered as the best that can be devised at present. These standards were adopted by the association in 1907. At the 1908 convention no additional standards were adopted, but certain "Recommended Practices" were adopted by the Association. The standards of truck parts adopted are (a) standard axles, journals, journal bearings, and journal boxes; (b) standard brake shoes, brake-shoe heads, and keys; and (c) standard section of tread and flange of wheel.

Axles. The forms and dimensions of axles as recommended by the Association are shown in Fig. 16. The diagrams show the different parts of an axle. At the ends of the axles are the journals *AA*, which are supported in the bearings carried in the journal boxes. Next to the journals are the wheel seats *GG*, upon which the wheels, bored slightly smaller than the axles, are firmly pressed. Slightly larger than the wheel seats is the gear seat. The gear wheel, through which the driving force from the motor is transmitted to the axle, is fitted tightly to this part of the axle. It is prevented from rotating on the axle by a steel key, which is driven into a slot, and into a similar slot in the hub of the gear wheel, registering with the axle slot. The remainder of the axle is available for the support of the motor, which hangs upon it by means of two bearings. At the ends of the journals, the axle is enlarged to form two shoulders which prevent endwise motion of the axle in the bearings.

On the diagram are given a number of useful data relating to the several standard axles, viz, (1) the safe loads which the axles can carry; and (2) the size of the motor to which each type of axle is adopted.

In addition to the dimensions shown in the diagrams, certain specifications as to the quality of steel to be used have been drawn up. While these are not the officially adopted standards of the Association, they represent average general practice.

STANDARD SPECIFICATIONS FOR STEEL AXLES

(1) MATERIAL. All axles must be made of steel by the open-hearth process and the material required shall have the following composition:

(2) CHEMICAL REQUIREMENTS.

	BASIC OPEN HEARTH	ACID OPEN HEARTH
Carbon.....	0.40 to 0.55 per cent	0.35 to 0.50 per cent
Manganese, not to exceed.....	0.70 per cent	0.70 per cent
Phosphorus, not to exceed.....	0.05 per cent	0.05 per cent
Sulphur, not to exceed.....	0.05 per cent	0.05 per cent

In no case must the total of carbon and manganese exceed 1.15 per cent.

(3) PHYSICAL REQUIREMENTS. Tensile strength, not less than 80,000 pounds per square inch. Elongation in 2 inches, not less than 20 per cent. Reduction in area, not less than 25 per cent.

(4) **TESTS.** One test per melt will be required, the test specimen to be taken from either end of any axle or from full-sized prolongations of same with a hollow drill halfway between the center and the outside parallel to the axis of the axle.

The standard turned test specimen, $\frac{1}{2}$ inch in diameter and $\frac{1}{2}$ -inch gauge length, shall be used to determine the physical properties. Drillings or turnings from the tensile specimen shall be used to determine the chemical properties.

The railway company must be notified in advance when axles will be ready for inspection and no shipment shall be made before tests shall have been completed and the inspector shall have advised that the axles are satisfactory.

(5) **STAMPING AND MARKING.** Each axle must have the heat number and manufacturer's name or initials plainly stamped on one end with stamps not less than $\frac{3}{8}$ inch high and have order number plainly marked with white lead.

(6) **INSPECTION.** All axles must be free from seams, pipes, cracks, or other defects and must conform to the sizes ordered, as per drawings which accompany these specifications.

Axles must be rough-turned all over with a flat-nosed tool, cut to exact length, have ends smoothly finished and centered with good 60-degree centers.

Axles that fail to meet any of the above requirements or that prove defective on machining will be rejected and returned at the expense of the manufacturer and must be replaced by him free of cost to the railway company.

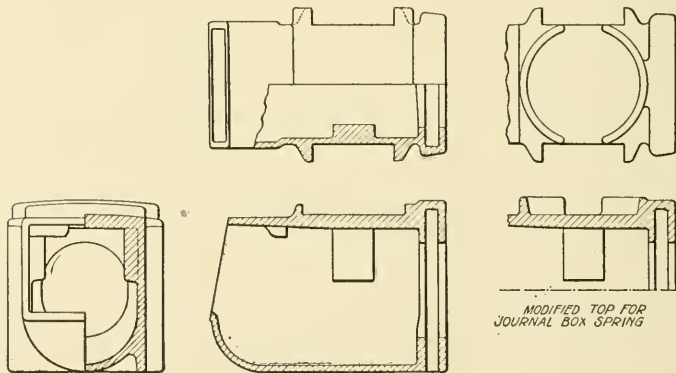

Fig. 17. American Electric Railway Engineering Association Standard Journal Boxes

Journal Boxes and Bearings. The Railway Association has recommended the general dimensions for journal boxes to correspond with the journal dimensions of Fig. 16. One of these boxes is shown in detail in Fig. 17, and its relation to the adjacent parts

of the truck can be seen in Fig. 10. It is a malleable iron casting with guide grooves on the sides into which fit the truck pedestal.

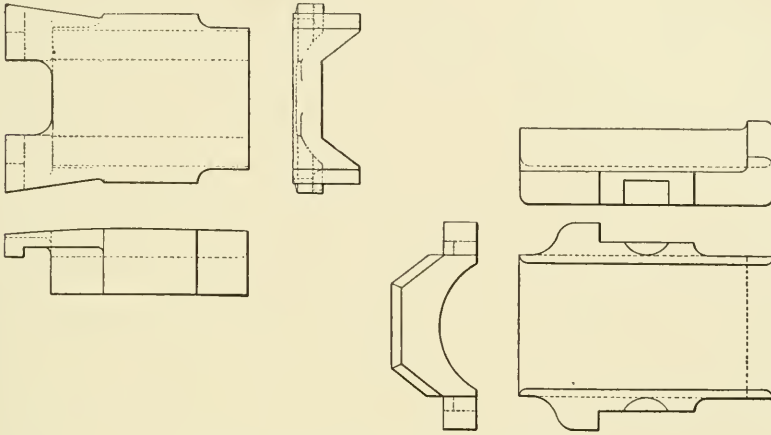

Fig. 18. M. C. B. Journal Bearing and Wedge

On top of the box is the seat for the equalizer bars, the ends of which rest thereon.

The two ends of the box have openings, one to admit the axle, the other, which is covered by a spring lid, to permit of the cleaning of the inside of the box and the replacing of the grease and waste, or the oil, used in lubrication. Inside the box are the lugs which keep the journal bearing in position. Fig. 18 shows such a journal

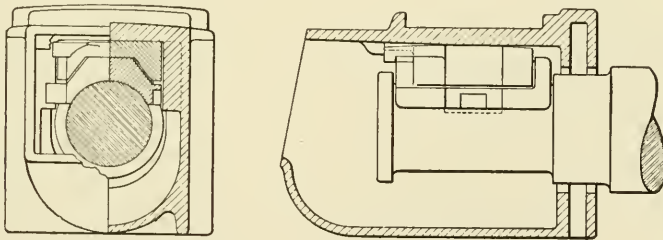

Fig. 19. Journal Box with Journal and Bearing in Position

bearing and the wedge placed above it to hold it in place. The space inside the journal box is sufficient to accommodate the journal, the bearing, and either a quantity of grease-soaked cotton waste or a quantity of oil with a simple ring or wick device to feed the oil to

the journal. As the journal bearing surrounds but the upper part of the journal, the lower part of the latter is in contact with the lubricant. On the wheel, or inner end of the box is a thin chamber open at the bottom, which permits excess lubricant to flow out upon the track rather than upon the wheels.

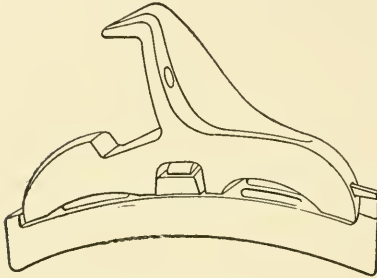

Fig. 20. Brake Shoe and Head

In Fig. 19 are shown the journal box, bearing, and wedge in their proper relation.

Brake Shoes. Cars are brought to rest through the friction between the rims of the wheels and cast-iron blocks pressed firmly against them. These blocks or "shoes" are curved to fit the rims of the wheels so as to give the best possible grip. The brake shoes wear away very rapidly in service so that they must be hung in such

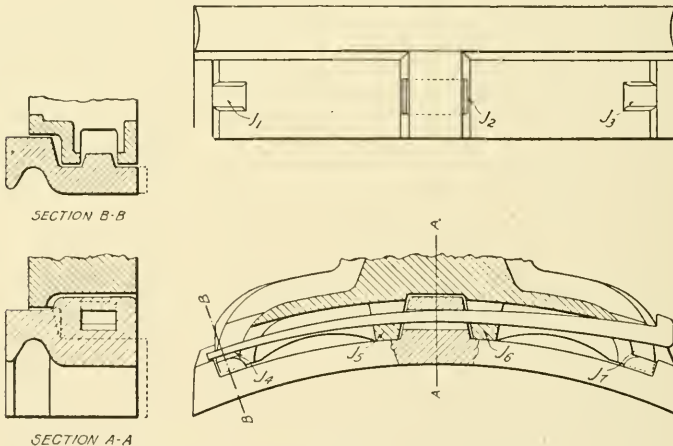

Fig. 21. American Electric Railway Engineering Association Standard Brake Shoe

a manner as to permit them to be replaced readily. They are, therefore, carried in supports called "brake-heads" to which they are attached by single keys. The heads, in turn, are hung by means of some kind of a link or other support from a fixed point on the trunk. (See *bh*, Fig. 10.) A picture of a combined shoe and head

is given in Fig. 20. Fig. 21 is from the A. E. R. A. Standardization Report. It is intended to give an accurate idea of the details of the preceding figure. On account of the irregular shape of the parts, they are difficult to show clearly in drawings. The principal point is to see how the brake shoe is supported in the head. The shoe is shown, in the head, in elevation and section at the bottom of the figure and at the top is given a plan without the head. The shoe consists essentially of a curved iron block, somewhat over $1\frac{1}{2}$ inches thick, and flanged to fit the rim of a car wheel. The shoe bears upon both the "tread" and the "flange" of the wheel. Projecting from the upper side of the shoe are lugs J_1, J_2, J_3 , by which it is held in proper relation to the supporting head. The center lug J_2 has a rectangular hole through it.

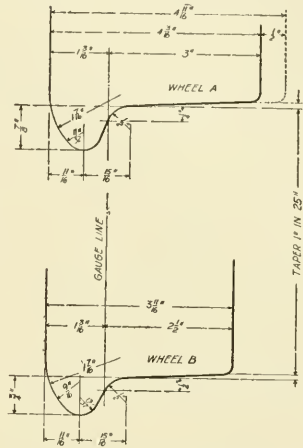
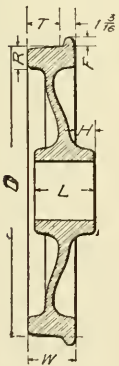

Fig. 22. American Electric Railway Engineering Association Standard Wheel Flanges

The head is a casting with projecting lugs J_4, J_5, J_6 , and J_7 . The center lugs J_5 and J_6 have rectangular holes corresponding to



RELATION OF TREAD WIDTH TOTAL WIDTH AND FLANGE HEIGHT		
T.	W	F
$2\frac{1}{2}$ "	$3\frac{11}{16}$ "	$\frac{3}{4}$ "
3"	$4\frac{3}{16}$ "	$\frac{7}{8}$ "
$3\frac{1}{2}$ "	$4\frac{11}{16}$ "	$\frac{7}{8}$ "

ROLLED STEEL WHEELS PROPOSED STANDARD SIZES				
D	T	R	H	L
33"	$2\frac{1}{2}$ " OR 3"	$2\frac{1}{2}$ "	$1\frac{15}{16}$ "	$2\frac{15}{16}$ "
34"	$2\frac{1}{2}$ "- $3\frac{1}{2}$ "	3"	$1\frac{15}{16}$ "	$2\frac{15}{16}$ "
35"	3"- $3\frac{1}{2}$ "	3"	$1\frac{15}{16}$ "	$2\frac{15}{16}$ "
36"	3"- $3\frac{1}{2}$ "	$2\frac{1}{2}$ "	$1\frac{15}{16}$ "	$2\frac{15}{16}$ "
37"	3"- $3\frac{1}{2}$ "	3"	$1\frac{15}{16}$ "	$2\frac{15}{16}$ "

Fig. 23. Standard Steel Wheel

those in lug J_2 of the shoe. These holes accommodate a taper key which holds the shoe and head together. The end lugs of the head, J_4 and J_7 , fit loosely over the corresponding lugs J_1 and J_3 , on the

shoe. Sufficient space is allowed over shoe lugs J_1 and J_3 to permit the taper key to pass through loosely.

Wheel Treads and Flanges. The standards of the Association are shown in Fig. 22 for wide and narrow tread wheels. The peculiar form of the contour has been determined from the experience of many roads as that best adapted for keeping the wheels on the rails and giving good wearing qualities. Uniformity in this matter is especially desirable so that the wheel manufacturers can supply wheels from stock without keeping too many varieties on hand. The cost of patterns and tools is reduced and the wheels can be made more cheaply. By the use of standard wheels, equipment can be interchanged between roads.

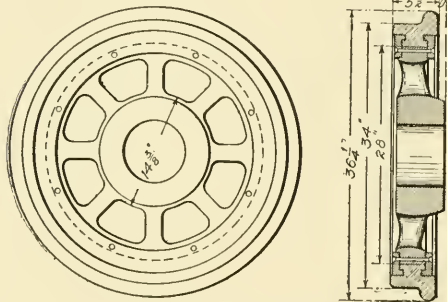

Fig. 24. Steel-Tired Wheel

Car Wheels. A wheel is shown in cross-section in Fig. 23. It consists of the *hub*, the *rim*, and the *web* or *spokes*. A projection of the rim, which is necessary to hold the wheel on the rails, is the *flange*. The hole in the center is the *bore*, and the outside

slightly conical surface of the rim is the *tread*. The rim may be of one piece with the body of the wheel or it may carry a steel tire.

The cheapest wheel is one made of cast iron with a hardened tread. Two different styles of cast-iron wheels are shown as parts of the trucks in Figs. 9 and 10. These figures should be examined with a view to determining the forms used to economize material and to give strength and stiffness. The tread is hardened or "chilled" by casting the metal against an iron band placed in the sand mould to form the tread. The result is such a hard tread surface that only an emery grinder will cut it. The principal objections to chilled wheels are the difficulty of truing them and the dangers caused by chipped flanges and brittle wheels. Cast iron itself is liable to flaws and this liability is increased by the chilling. For low-speed service, however, chilled wheels are entirely satisfactory.

The rolled-steel wheel and the steel-tired wheel are preferred for high-speed service. Such wheels are free from the objections mentioned for chilled wheels and this is well worth the greater cost. As the rolled-steel wheels are in one piece like the cast-iron wheels, they are inherently preferable to the steel-tired wheels which are built up of several pieces. Fig. 23 shows the cross-section of a steel wheel recommended by the A. E. R. A. Committee on Equipment. By one process the rolled wheels are made from steel ingots, sliced cold into billets, each of which contains steel for one wheel. The billet is then pressed hot under enormous pressure in a hydraulic press into somewhat the form of the wheel. Next, a hole is punched through the center, and finally the wheel is rolled in a very heavy mill to the desired form. In this mill the rim is surrounded by rolls except in the portion covered by the web. While it may seem strange to make a wheel without cutting, it is possible, because steel "flows" just like lead if the

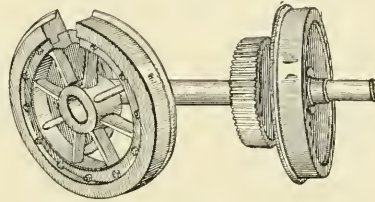

Fig. 25. Wheels and Gear Showing Section of Rim

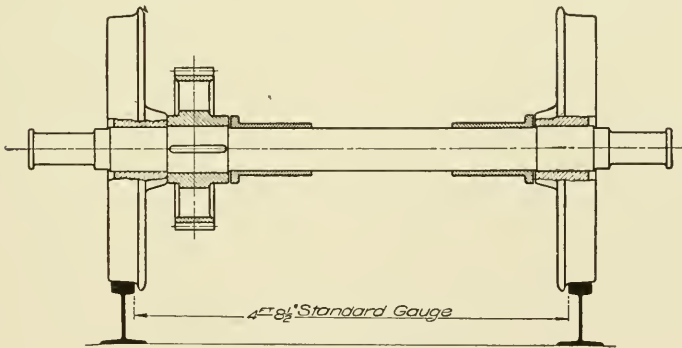

Fig. 26. Part Section of Wheels, Axle and Gear

pressures applied are great enough. The rolling process, also, is beneficial to the metal in rendering it compact and homogenous.

While solid-steel wheels are coming into use, the built-up wheel is more usual at present. This consists of cast or forged hub, spokes, and rim, with a steel tire shrunk on. Such a wheel is shown in elevation and in section in Fig. 24. The drawings show the light

retaining rings riveted to the rim on the two sides of the tire to prevent the latter from slipping off, which it tends to do when it wears thin. As stated above the tire is "shrunk" on. When cold its internal diameter is slightly less than that of the external diameter of the rim. When heated it expands sufficiently to allow it to slip over the rim and when it cools it contracts and binds the rim firmly. The tire is about 3 inches thick when new and it can be worn down until it is less than 1 inch thick. Another satisfactory arrangement of tire is that illustrated in Fig. 25. There are no retaining rings required in this case, the tire being bolted to the rim. Such a tire cannot get loose.

Axle Gears. On the car axle, Fig. 26, is mounted a gear wheel which meshes with the pinion, or small driving gear, on the motor shaft. The axle gear is of cast steel, and of the form shown in Figs. 27 and 28. Fig. 27 is a solid gear which must be put on before the

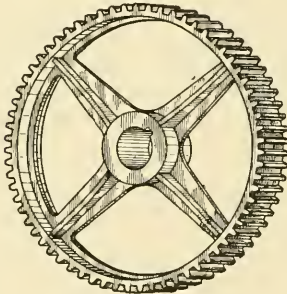

Fig. 27. Solid Axle Gear

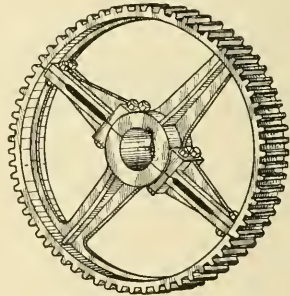
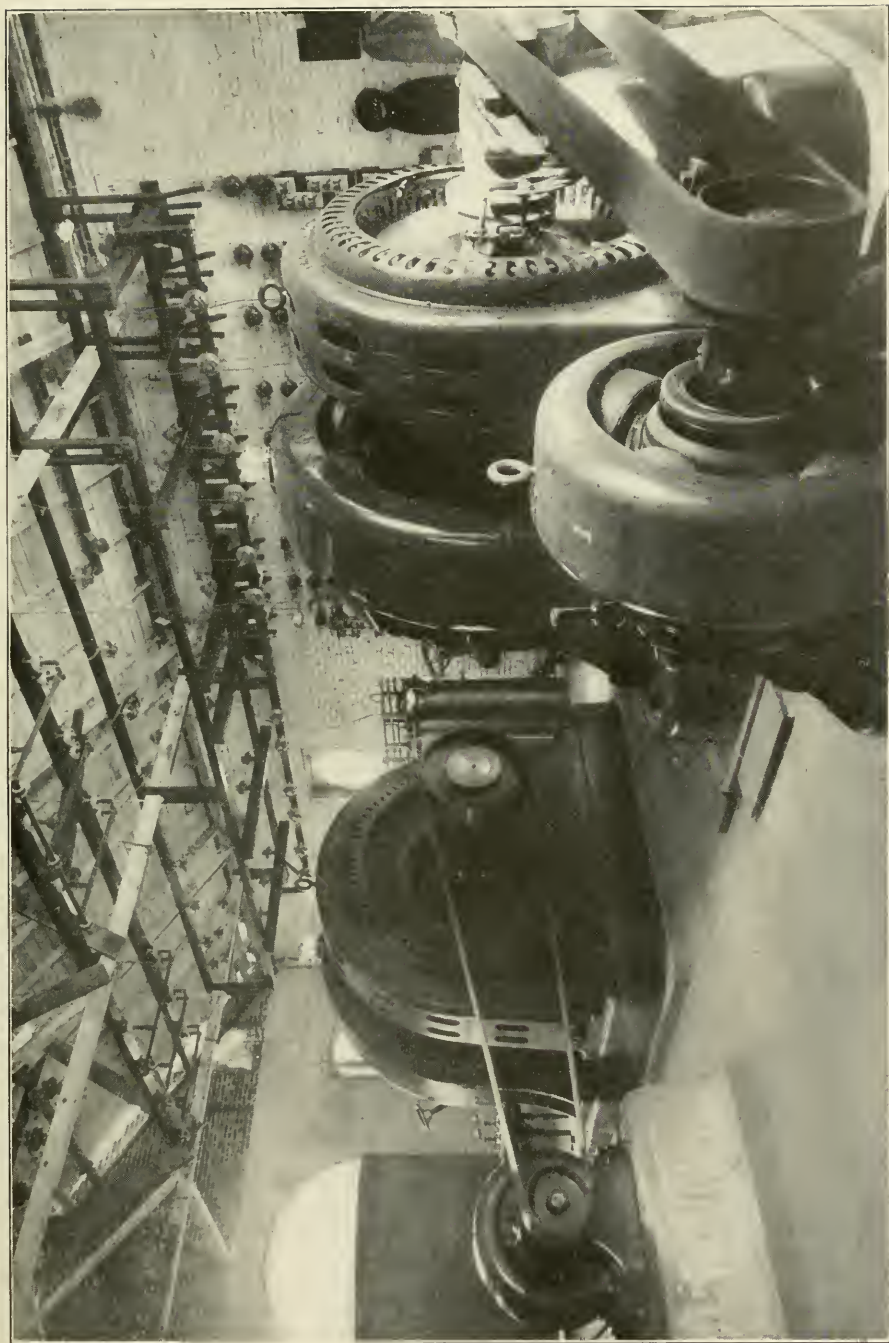

Fig. 28. Split Axle Gear

second wheel is pressed into position. The position of the axle gear on the axle can be seen in Figs. 16 and 26. The gear is keyed to the axle to prevent turning. Fig. 28 shows a gear which is split along a diameter with the two halves bolted together. This gear can be mounted on the axle without disturbing a wheel. A recent form of gear is provided with a removable rim, so that the same center can be used even after the teeth wear out.

The gear rim is cut accurately with involute teeth, great care being taken to insure good wearing surfaces to prevent friction. There is always, however, a considerable loss at this point, 3 per cent or more of the power of the motors being absorbed.



CROCKER-WHEELER SYNCHROUS MOTOR-GENERATOR SET WITH TRANSFORMERS, INSTALLATION FOR OLIVE SUB-STATION, LOS ANGELES PACIFIC RAILWAY COMPANY, LOS ANGELES, CALIFORNIA

Courtesy of Crocker-Wheeler Company

Wrought-Iron Bars for Electric Railway Purposes. As it is important to have a good quality of iron for use in brake rigging, etc., the Association recommends the following specifications:

SPECIFICATIONS FOR WROUGHT-IRON BARS

(1) **MATERIAL.** The material under these specifications will be ordered as "Wrought-Iron Bars." It must have been originally made by the puddling process and as furnished may consist of new muck bar iron or of a mixture of muck bar and scrap, but it must be free from admixture of steel scrap. It must be smoothly and truly rolled to the dimensions ordered and must be free from slivers, cracks, depressions, and burned edges.

(2) **PHYSICAL PROPERTIES.** (a) Tensile strength per square inch to be not less than 49,000 pounds for rectangular bars and 50,000 pounds for round bars. (b) Elastic limit per square inch to be not less than 25,000 pounds for rectangular bars and 25,000 pounds for round bars. (c) Elongation in 8 inches to be not less than 22 per cent for rectangular bars and 25 per cent for round bars. (d) Bending: When subjected to bending tests, either hot or cold, the iron must bend through an angle of 180 degrees, around a diameter equal to the thickness of the bar, without crack or fracture. (e) Nicking: When nicked evenly on one side and bent back by a succession of light blows on the nicked side, and broken, iron must show a generally fibrous structure, free from steel or coarse crystalline spots. Not over 25 per cent of fracture shall be granular.

(3) **NUMBER OF TESTS.** Samples shall be taken at random, two test pieces from each shipment, one for tension and one for bending.

(4) **MARKING.** Each shipment shall be marked, stating railway company's requisition number, name of shop where sent, number of bars and weight of bars in pounds.

(5) **VARIATIONS.** All sections must be true to size and shape ordered. Round iron must conform to the limit gauges adopted as standard by the American Railway Mechanics' Association and also by the Master Car Builders' Association.

(6) **FINISH.** All bars must be practically straight, smooth, free from cinder spots, blisters, cracks, slivers, injurious flaws, imperfect edges, unwelded seams and mechanical defects of all kinds.

(7) **REQUIREMENTS.** In competent hands iron must be capable of being worked at a proper heat without injury and give perfect welds. The iron will be inspected at the shop where used, and if it fails to meet the requirements of these specifications, will be rejected and returned at the expense of the manufacturer.

MOTORS

DIRECT-CURRENT SERIES TYPE

Construction. The motor used for traction work is of the *series type*, that is, the armature and field circuits are connected in series. The connections of such a motor are shown in Fig. 29.

The essential parts of the motor are: (a) The field magnet, consisting of four pole-cores, attached to a cast-steel ring or yoke, and carrying four well-insulated coils; (b) an armature, of the series, or wave-wound type, with commutator; (c) a brush-holding mechanism to support the two sets of carbon brushes which are mounted at right angles; (d) an enclosing case for keeping out dust and moisture.

Figs. 30, 31, and 32 show a railway motor viewed from different points and with the frame open and closed. These figures should

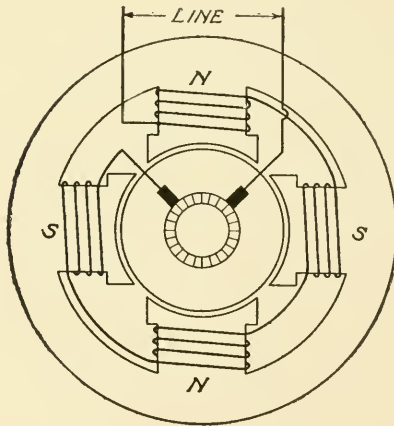

Fig. 29. Diagram of Series Motor

be studied carefully for the purpose of noting the above-mentioned parts. This motor consists of a thin cast-steel frame or shell, roughly cylindrical in form. It is split horizontally into two halves to permit the internal parts to be readily inspected and replaced. The four pole-cores are bolted to the frame as shown, the steel being made thicker where the shell carries the magnetic flux. Two pole cores are carried each by the upper and lower halves.

The two halves are hinged, but they are firmly bolted together when the motor is in service.

The armature bearings are carried by the ends of the frame, thus assuring correct alignment with the field bore. The frame also carries the axle bearings by means of which a part of the weight of the motor is carried on the car axles. Projecting from the side of the shell opposite to the axle bearings are two suspension lugs through which the remainder of the weight of the motor is supported by a suspension bar or cross bar which forms a part of the truck frame. (Examine the pictures of trucks for the cross bars.)

There are several covered openings in the frame provided to permit inspection of the inside of the motor without separating its two parts. A large opening is located over the commutator so that

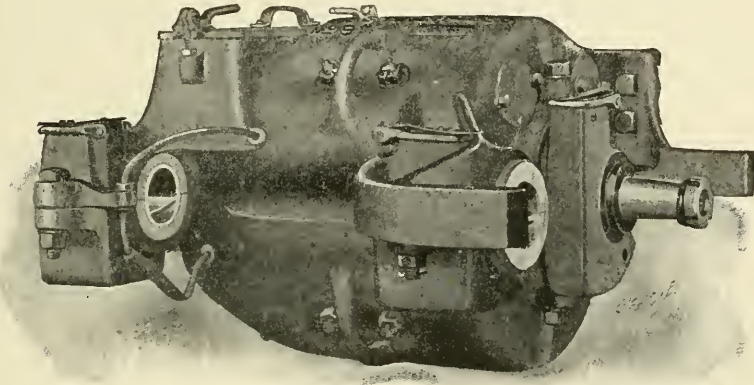

Fig. 30. Westinghouse Railway Motor, 35 H. P.

the commutator and brush rigging may be inspected and brushes replaced. In the lower part of the frame are hand-holes for examination of clearance between armature and field poles and removal

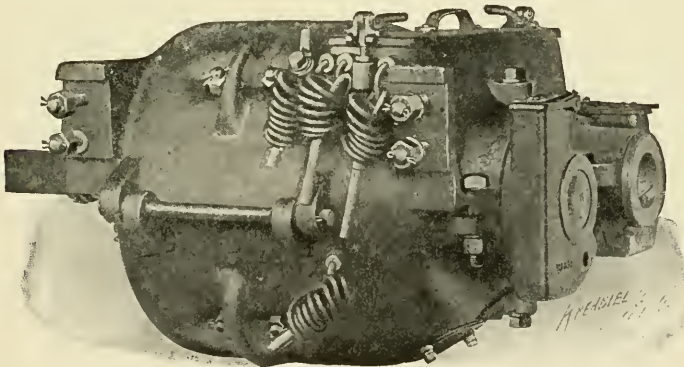

Fig. 31. Westinghouse Railway Motor—Commutator End

of dirt. The holes through which the armature and field wires are brought through the case are bushed with insulating material.

Field Pole-Cores and Coils. The four field pole-cores project radially inward from the frame, each at an angle of 45 degrees from the horizontal. Each is attached to the frame by two bolts. Each

core consists of sheet-steel punchings riveted together between iron and plates. As it is impossible to screw the supporting bolts into such a laminated structure, one of the rivets is made extra large and the bolts screw into this. On one end the pole-core spreads out

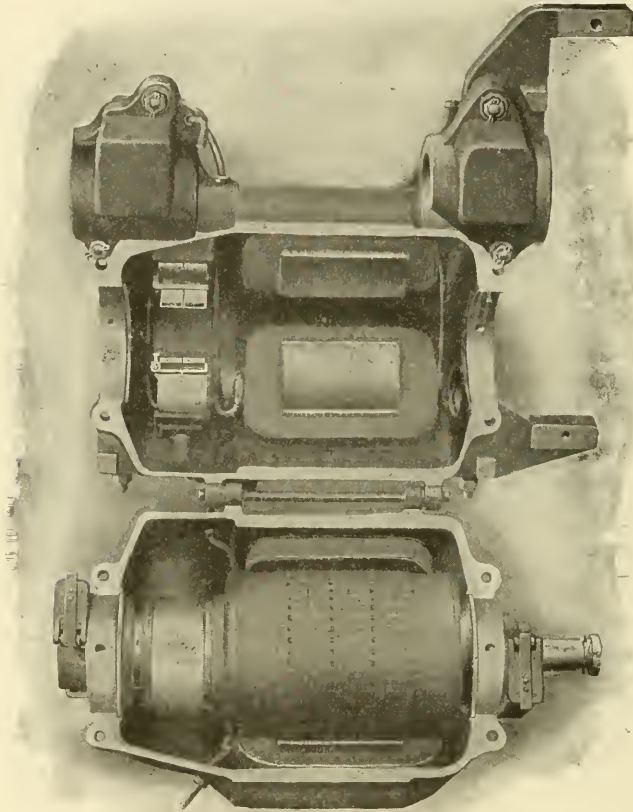

Fig. 32. Westinghouse Railway Motor—Lower Field Down

into a shoe which forms a support for the field coil and at the same time serves to increase the pole surface.

The field coils are wound of copper strap insulated with asbestos and mica and thoroughly taped. Oiled duck is also used to furnish good mechanical protection against chafing. Many users have the coils impregnated with water-proofing asphaltum. The

coils when mounted on the pole-cores are supported by the pole tips from which they are separated by leatheroid washers. The coils

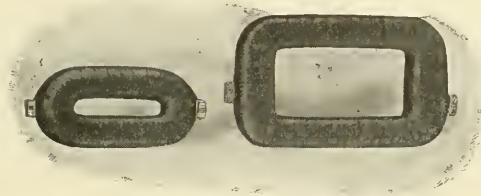

Fig. 33. Main and Interpole Field Coils

are pressed firmly between these washers by flat steel springs placed between them and the case; thus they are not permitted

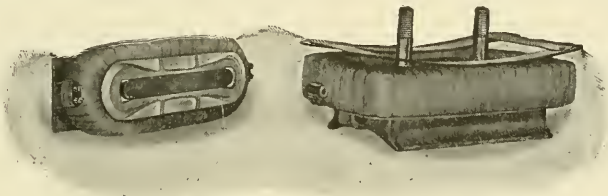

Fig. 34. Main Pole and Interpole Complete

to vibrate and injure their insulation. A field coil is shown in Fig. 33 and a coil mounted on a pole piece with the flat steel spring in place is shown in Fig. 34.

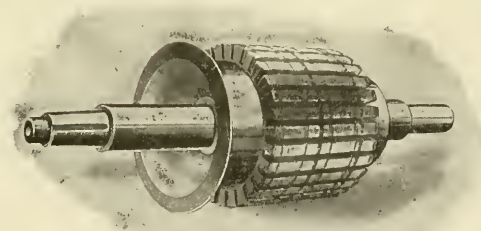

Fig. 35. Armature Core

Armature Core and Coils. The armature core is built up of thin steel sheets, insulated from each other by coats of japan and clamped firmly between iron end plates. To improve ventilation several spaces are provided by separating the sheets by means of

ribbed plates. The surface of the armature is slotted to accommodate the coils, the number of slots in this motor being 41.

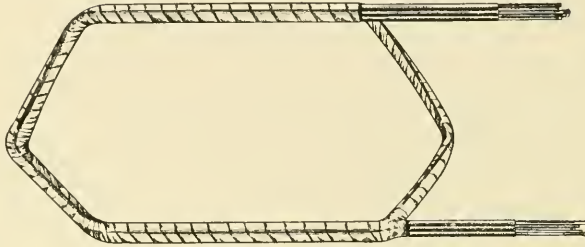

Fig. 36. Armature Coil

Fig. 35 shows a complete core mounted on the shaft. The flanged cylindrical casting at the left supports the ends of the coils which project beyond the core.

In the slots are placed coils similar to those shown in Fig. 36. There are here three coils, wound side by side, and insulated together each coil having two or three turns. The insulation consists of the cotton covering on the individual wires, of fuller board partitions between coils, and of a wrapping of rope paper and linen tape. The whole is impregnated with insulating varnish. A set of three assembled and insulated coils fills one-half of a slot. In winding the armature with these coils, 41 are required, this being the number of slots.

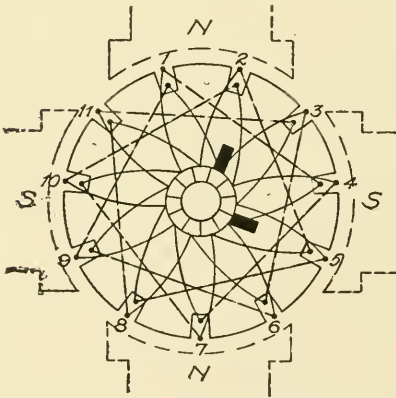

Fig. 37. Diagram of Armature Winding

of bronze wire are wound about the core to hold the coils in place. In connecting the coils to the commutator the simplified diagram of Fig. 37 will be found useful. This has, for simplicity, but 11 slots, with one coil in each, and 11 commutator bars, whereas the motor under discussion has 123 coils and bars. However, the principle is exactly the same. In the actual motor

the three coils in one slot are treated as if they occupied separate slots in the diagram.

In Fig. 37 the path of the winding can be followed thus: A coil is in the top of slot 1 and in the bottom of slot 4; another in the top of 2 and bottom of 5, etc. One terminal of the first coil goes to commutator bar 10, the other to 4; the terminals of the second coil to 11 and 5; and thus around the core until the connections are complete.

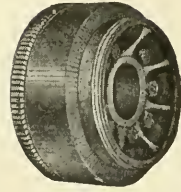

Fig. 38. Commutator

This is a wave-winding and, when connected in this way and with the brushes placed as shown, there are two parallel paths through the winding from brush to brush. Each path is through the field under all four poles so that any possible inequality of the fields does not affect the counter-electromotive force and hence the distribution of the current in the armature.

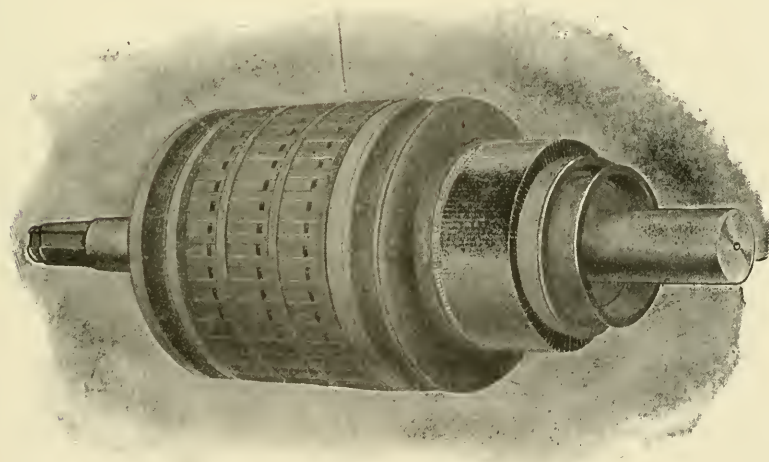

Fig. 39. Armature Complete

Commutator. The commutator is shown in Fig. 38. It does not differ essentially from the usual form and consists of 123 hard drawn copper bars, separated by soft mica and assembled in cylindrical form. These bars are held together in the manner usually followed with this kind of construction. A cast-iron shell has

a V-shaped flange at one end. The ends of the bars are formed to fit under this flange. The other ends fit under a steel taper ring which is pressed against the bars by a clamping nut. The bars are insulated from the bushing and ring by moulded mica. One end of each bar is slotted for the accommodation of the leads from the armature winding.

The complete armature, with windings and commutator in place, is shown in Fig. 39.

Brushes and Brush-Holders. The brushes for railway motors are carbon blocks, 2 inches, more or less, in width, $\frac{1}{2}$ to $\frac{3}{4}$ inch in thickness, and 2 inches, more or less, in length. The exact size differs with the style of motor. These brushes are mounted radi-

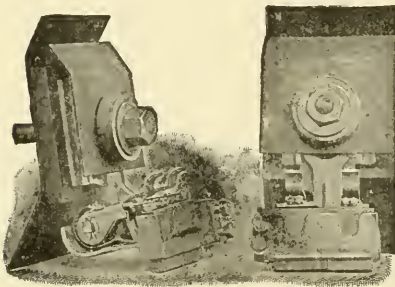

Fig. 40. Brush Holders

ally or nearly so and they are pressed against the commutator by spring pressure fingers. Fig. 40 shows the brush holder of this motor more in detail. It comprises a brass frame in which two brushes, placed side by side, slide easily. They are pressed radially inward by pressure fingers which are pulled against the ends of

the brushes by adjustable-tension springs. The pressure fingers may be raised, for replacing the brushes, by means of the bent levers shown in the figure.

The brush-holder casting is bolted securely to lugs cast on the inside of the motor frame and insulated therefrom by means of hard composition sheets, washers, and tubes. The lug by which it is clamped to the frame is slotted to permit radial adjustment of the holder.

The armature terminal lugs are cast as part of the brush-holder so that the current may be conducted away from a point as near the commutator as possible. No unnecessary heat is produced by this arrangement.

Bearings. The set of four bearings is shown in Fig. 32. All of the bushings are cast-iron cylinders lined with babbitt metal. These are supported in cast-iron housings. The armature-bearing

housings have bored seats and are clamped between the two halves of the field casting. The axle-bearing bushings are split. They are supported by hollow extensions from the main frame and firmly clamped between these and cast-steel axle caps above.

The bearing housings provide not only support for the bushings, but also form chambers for the lubricant. The section of one of the bearings of this motor is shown in Fig. 41. A large chamber at one side of the bushing is packed with wool waste. This becomes saturated with oil which is poured into the smaller chamber to the left of it in the figure. The side of the bushing is cut away to allow

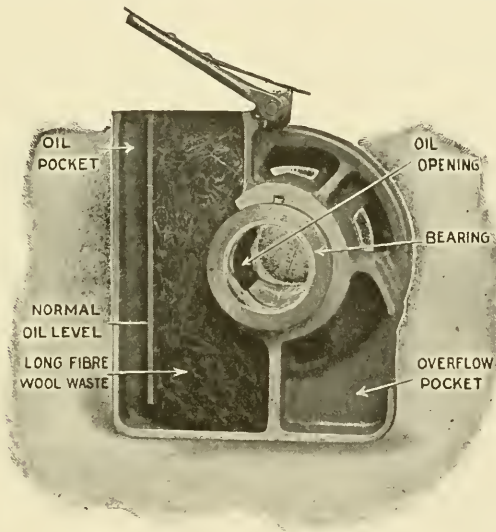

Fig. 41. Cross-Section of Bearing Housing

the oil-soaked waste to come into contact with the shaft which is thus well lubricated. Surplus oil passes into the chamber to the right and spills into the roadway.

An important feature of the lubrication is the oil ring which is carried on each end of the motor shaft to prevent oil from getting into the armature winding and commutator. Such a ring is shown to the right of the commutator in Fig. 39. The ring revolves in a groove in the bearing housing. As the oil reaches this ring it is thrown outward by centrifugal action and is discharged outside the frame.

Leads and Connectors. Four flexible cables are brought through the motor case, two each from armature and field. The cables are rubber-covered and protected by an extra-braided covering. They pass through holes bushed with semi-soft rubber. As the cables must be disconnected frequently in every-day use, their terminals are provided with connectors by which they may readily be coupled to the motor wiring. A pair of these connectors is shown in Fig. 42.

Suspension. The method of suspending this motor may easily be understood from an examination of the suspension lugs shown in Fig. 31 and of the suspension bars which form parts of the trucks. The cross bars are bolted to the suspension lugs, the cushioning effect which is necessary being provided by spring support of the cross bars.



Fig. 42. Field Lead Connectors

Gearing. As the speed of the motor shaft is much greater than that desired at the car axle a considerable reduction, by means of the spur gear wheels, is necessary. On the motor axle is the forged steel pinion. This is keyed to the shaft and is held on a taper fit by means of a nut. The end of the shaft is threaded. The taper fit makes a rigid mounting for the pinion which is easily removed. On the car axle, as already explained, is the cast-steel axle gear usually split for ease of removal. The pinion has accurately-cut teeth to correspond with those of the axle gear.

Gear Case. To protect the gears from dirt they are surrounded by a malleable iron box, mounted securely on the motor frame. Lugs are provided on the frame for the purpose. The gear case is made in two parts as otherwise it would be impossible to put it in position. While the motor which we are studying has a cast case it should be noted also that cases made of sheet iron are coming into favor because there is considerable breakage of the cast cases. The malleable iron cases are, however, standard practice at present.

Other Types of Railway Motor. A particular motor has been described in detail in order that the construction principles may be understood. All direct-current railway motors have these same general features but they differ in detail. There are many standard motors of differing size and mechanical details. Large motors necessarily are made different from small ones on account of the re-

striction of space which renders it difficult to get a large motor into a small compass. It is not always considered desirable to split the frame, especially in large motors. As an illustration of this is the box-frame motor shown in Fig. 43. This is a view from the suspension-lug side, that is, the side opposite from the axle-bearing side. The motor bearings in this motor are carried by large circular plates, which cover holes in the ends of the case, the holes being large enough to permit the passage of the armature. The bearing plates are turned and they seat on the bored edges of the holes, preserving perfect alignment of bearings with field bore. The end plates are

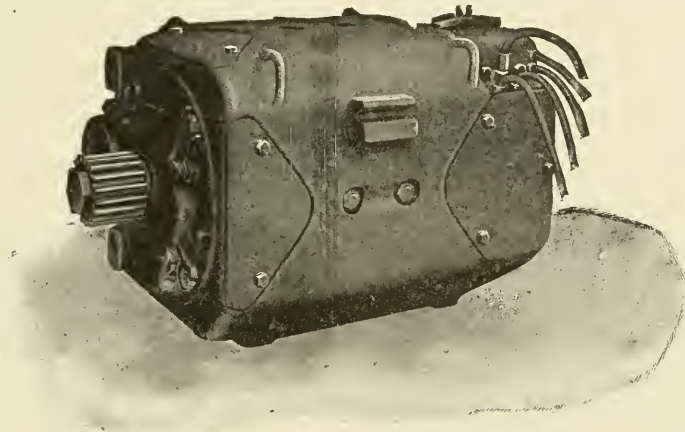

Fig. 43. Box Frame Motor—General Electric Company

firmly bolted to the motor casing. This motor is provided with a number of ventilating holes which are shown closed by covers in the figure. In dry weather, and in service where the motors are not exposed to the weather, these cover-plates may be removed and the ventilation thereby improved.

The student will naturally inquire how the heavy armature can be removed from this motor without injury. There are two ways by which this can be done. The motor may be stood on the commutator end and the armature, with pinion and pinion end bearing, may be lifted out by lifting tackle. Another way is by means of a special device built for this motor. It consists of two lathe centers mounted on a lathe bed. These centers are pressed into the conical holes in the ends of the motor shaft and support the armature. The motor casing rests on a flat carriage which

rolls on the lathe bed. By loosening the end bearings the casing can be moved aside, exposing the armature for inspection and repairs.

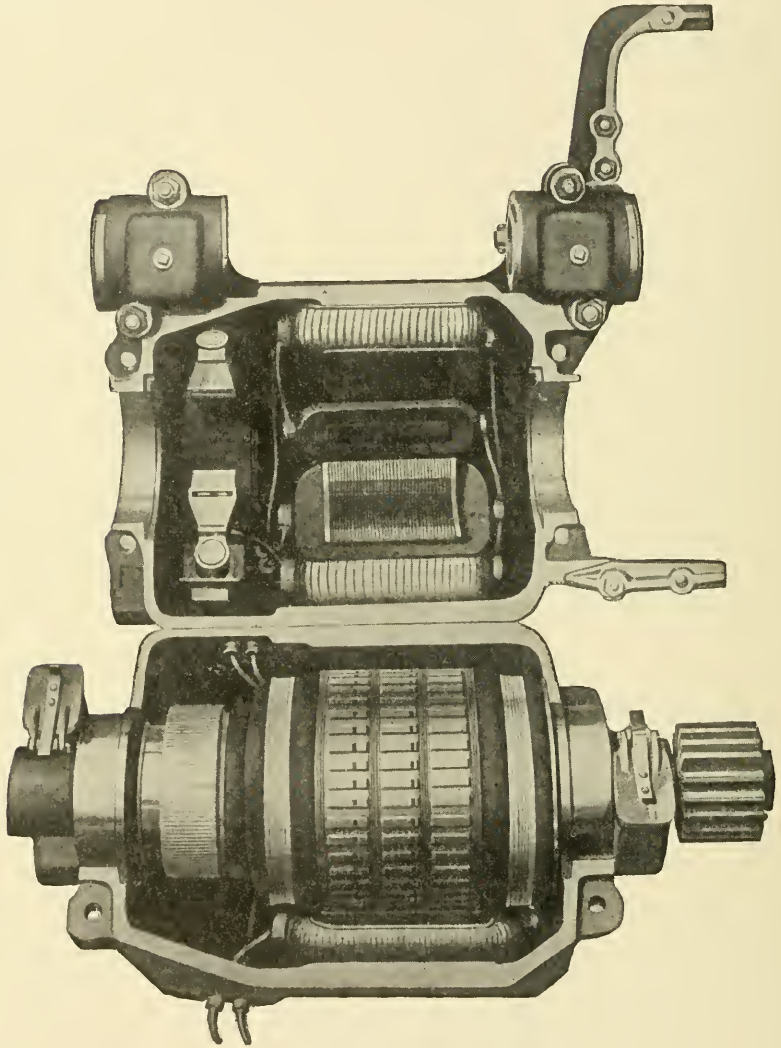

Fig. 44. Allis-Chalmers Inter-pole Motor

The Inter-Pole Motor. One of the most important recent advances in railway motor construction is the introduction of the commutating-pole principle. The student will remember from his

previous studies of commutation that the current must reverse in the armature coil which is passing under the brush, in a very short time. This it has difficulty in doing because the current cannot be reversed instantly. Electricity acts in a circuit as if it possessed inertia, the current being analogous to mechanical velocity. The consequence is, in many cases, sparking or arcing between the brushes and the commutator. If, by any means, the coil which is short-circuited can be made to cut a magnetic field in such a direction as to produce an electromotive force which tends to reverse the current, then the sparking can be eliminated. The most direct means for producing such a reversing field is to insert extra poles in between the brushes, exciting these by a winding connected in series with the main field.

Fig. 44 shows a modern motor in which this principle has been applied. The commutating poles are narrow cast-steel poles carrying coils of fewer turns than the main winding. The mechanical construction and insulation of these coils are the same as those of the main winding, Figs. 33 and 34.

Large numbers of these motors are being made by the several companies engaged in making railway motors and as the merits of these motors become better known they will be used to an even greater extent.

Operating Characteristics. As the name implies, the armature and field circuits of the series motor are connected in series, consequently the same current flows in both. As a result of this connection the speed, torque, and current relations are different from those in other types of motor. The relations of these quantities are shown in Fig. 45. In these curves the current values are given as abscissæ and the torque and current values as ordinates.

Take, for example, the curve between torque and current. The curve shows that the torque increases with the current, being nearly proportional to it. This torque is proportional (a) to the strength of the field, and (b) to the current with a given number of armature conductors. If there were no saturation in the magnetic field the torque would, therefore, be proportional to the square of the current. There is a great deal of saturation, especially in the armature teeth, hence the torque curve does not bend upward very much.

The speed of a given motor armature is proportional to the strength of the field and to the applied electromotive force, neglecting the e.m.f. drop in the armature and field resistance. It is necessary for the armature, by the cutting of the conductors across the field, to produce a counter e.m.f. equal to the impressed e.m.f. (neglecting, as stated above, the resistance drop). Therefore, in a weak field, the armature runs faster, and in a strong field, slower. This is clearly brought out in the curves where it will be noted that

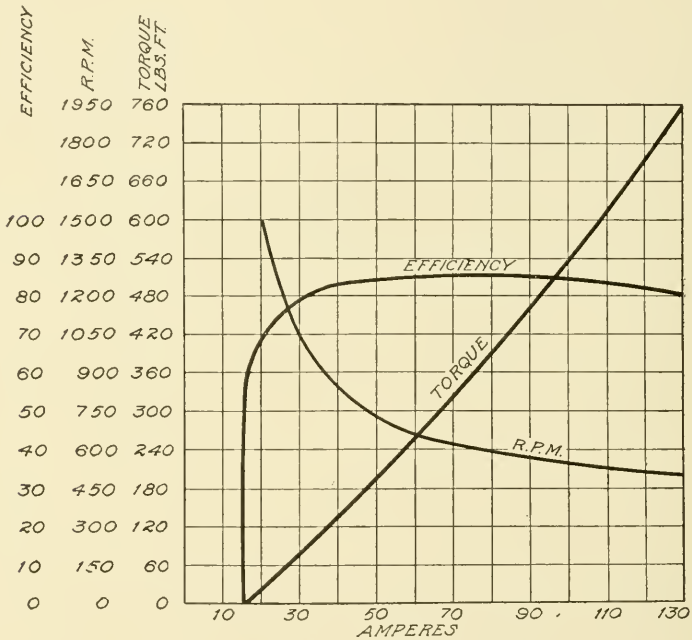

Fig. 45. Series Motor Characteristic Curves

a small value of current—or weak field, as the same current flows in the field circuit as in the armature circuit—corresponds to high speed, and *vice versa*.

ILLUSTRATIVE PROBLEM

Use of Motor Curves. A 20-ton car is equipped with two motors to which the curves of Fig. 45 apply. The motors are so geared to the car axles that the latter run slower by the ratio 1:4.06. The car wheel is 33 inches in diameter. Assume that it requires 20

pounds per ton, applied along the direction of motion, to overcome friction. Determine with the aid of the curves the following items: (a) At what speed will the car mount a 5 per cent grade? (b) How much current will it draw from the line while climbing this grade? (c) How much mechanical power will each motor be developing? (d) How much electrical power will each motor be taking (the voltage for which the speed curve was derived is 500)? (e) What is the efficiency of the motors?

Solution. (a) and (b). In Fig. 46 is represented the car on the grade. To pull it up the grade will require a force made up of two components, (1) that required to overcome friction; and (2) that required to lift the car. The former is 20 pounds per ton, or 400 pounds. The latter is 5 per cent* of the weight of the car, or 2,000 pounds. The total force required is 2,400 pounds, which is

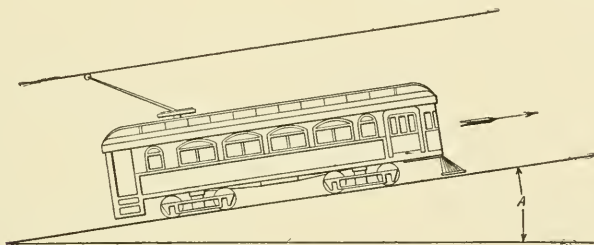

Fig. 46. Diagram of Car on Grade

independent of the speed, the friction being assumed constant: This force is produced by two motors, hence each must produce one-half. To use the curves requires the transfer of this force to terms of torque. Each motor must deliver at the wheel tread a tractive effort of 1,200 pounds. This means an axle torque of

$$T = \frac{16.5}{12} \times 1,200 = 1,650 \text{ pound-feet}$$

or pounds at 1 foot radius. The motor torque is less than this—as the motor shaft runs faster than the car axle by the ratio of the number of gear teeth to pinion teeth—by the gear ratio. Or

*For convenience it is customary to define the per cent grade of a track as the ratio of the lift to the distance traveled, or the sine of the angle A , multiplied by 100. The per cent grade is, therefore, numerically equal to the number of feet rise per 100 feet traveled.

$$\text{motor torque} = 1,650 \times \frac{1}{4.06} = 406.5 \text{ pound-feet}$$

From the curves this torque is seen to correspond to 80 amperes per motor, or 160 amperes for the car, and this number of amperes corresponds to 588 revolutions per minute.

To find the miles per hour from the r.p.m. we note that one motor-shaft revolution corresponds to $\frac{1}{4.06}$ revolution of the car axle. As the wheel is 33 inches or $\frac{33}{12}$ feet in diameter, one revolution of the wheel advances the car $\frac{33}{12} \times 3.1416 = 8.65$ feet (3.1416 is the ratio of the circumference of a circle to its diameter). One revolution of the motor armature then advances the car $\frac{8.65}{4.06}$, or 2.13 feet. As the motor armature makes 588 r.p.m. in this case, the corresponding rate of car travel is

$$\text{speed} = 2.13 \times 588 = 1,252 \text{ feet per minute}$$

then

$$\text{miles per hour} = 1,252 \times \frac{60}{5,280} = 14.2$$

(c) The mechanical power produced by each motor is the product of the speed of a point on the torque circle—that is, of a circle of one foot radius—and the torque. Remembering that 1 horse-power is 33,000 feet-pounds per minute, we have

$$\text{m.h.p.} = \frac{588 \times 2 \times 3.1416 \times 406.5}{33,000} = 45.5$$

(d) The electrical power input in watts is the product of volts and amperes, or

$$\text{watts} = 500 \times 80 = 40,000.$$

As 746 watts equal 1 electrical horse-power, the input in this unit is

$$\text{e. h. p.} = \frac{40,000}{746} = 53.7$$

(e) The efficiency is the ratio of output to input, in this case of m. h. p. to e. h. p. This is usually referred to in per cent, so that



INSTALLATION OF GENERAL ELECTRIC PNEUMATICALLY-OPERATED HIGH TENSION SWITCHES FOR THE
MISSISSIPPI RIVER POWER COMPANY

TABLE I
Motor Efficiencies for Different Track Grades

GRADE	TRAC- TIVE EFFORT PER MOTOR	TORQUE	CURRENT	SPEED		EFFICIENCY
				R. P. M.	M. P. H.	
1 per cent	400	135.8	40.0	829	20.0	82.0 per cent
2 per cent	600	201.6	50.0	737	17.8	83.5 per cent
3 per cent	800	271.0	60.5	673	16.3	85.0 per cent
5 per cent	1200	406.5	80.0	588	14.2	85.0 per cent
10 per cent	2200	746.0	128.0	497	12.0	81.5 per cent

the ratio must be multiplied by 100. Then

$$\text{efficiency} = \frac{45.6}{53.7} \times 100 = 85 \text{ per cent}$$

The student should, for practice, make the above calculations for other grades, say for 1 per cent, 2 per cent, 3 per cent, 10 per cent. The answers for these grades are given in Table I. The same principle can be applied to level track, *i. e.*, zero per cent grade. It is interesting to note that a car equipped with series motors climbs steep grades slowly and hence does not require as much power from the line as would be necessary with constant speed motors of the shunt type. As has been pointed out before, this is due to the stronger field which is produced at slow speeds by the large currents.

Commercial Motor Curves. In making calculations of series motor performance, it is very convenient to have the characteristic motor curves in terms of current, horizontal or tractive effort, and car speed. This can be done for given wheel diameter and gear ratio. There must, obviously, be a different set of curves if either of these be changed. In the bulletins of the manufacturing companies there are usually given several sets of curves for each motor with usual gear ratios and wheel diameters. From the data and illustrations already given, the student should have no difficulty in plotting a set of curves for given wheel diameter and gear ratio if he has the motor torque and speed curves. He should also, given a set of commercial curves, be able to change them to the curves for other wheel diameters and gear ratios.

A set of curves in the ordinary form is given in Fig. 47. Here the speed curve is plotted in miles per hour, instead of revolutions per minute, and the motor torque is transformed into tractive effort. This set of curves includes the effect of the gear friction which in the previous problems we assume to be included in the allowance for mechanical friction (20 pounds per ton). The gears

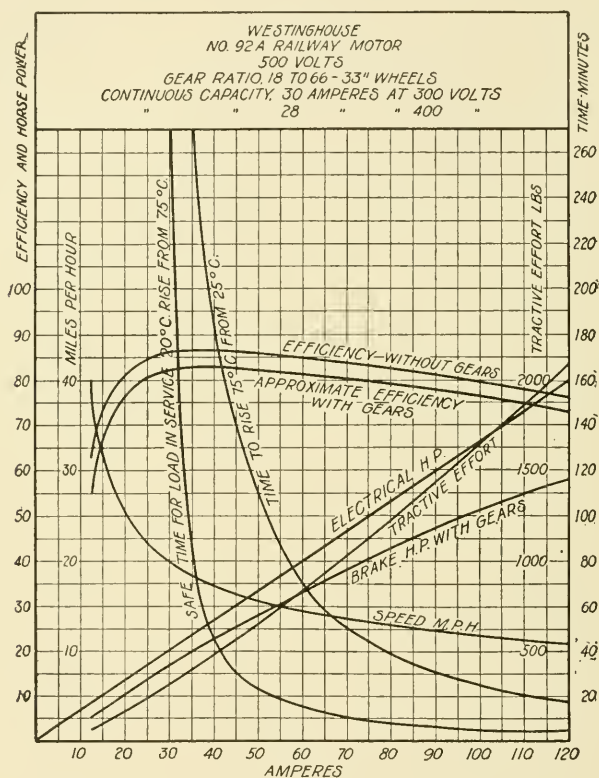

Fig. 47. Characteristic Curves—Westinghouse Railway Motor

are seen to lower the efficiency about four per cent. As the gears are not really a part of the motor the loss in them is not chargeable against the motor. On the other hand, as gears are almost invariably used with motors, it is necessary to know whether or not the efficiency curves as given include gear friction.

Motor Heating. The output of a railway motor, like that of other electrical apparatus, is determined by the allowable heating.

A rise of temperature from 50° to 75° C. above the atmosphere is all that can be allowed. The heating is caused mainly by the power loss in the resistance of the windings and by the hysteresis loss in the armature core. Small losses also occur due to brush and bearing friction. Fig. 47 shows a curve plotted between amperes and the length of time during which this current may be safely carried. The heading of the curves states that the motor may operate continuously at 30 amperes and 300 volts or at 28 amperes and 400 volts. These various data require explanation. In the first place the curve shows that if the average load is such as to draw 50 amperes, the motor will heat up from 25 degrees to the limiting temperature in 110 minutes or from 75 degrees in 23 minutes. It must be allowed to cool down before it can be used again. If the current drawn be greater, the time is more than proportionately reduced because the heating loss varies as the square of the current. A casual inspection of the curves would indicate that a railway motor would, in a short time, become so hot as necessarily to be set aside to cool. Fortunately, however, the ordinary railway load is of a very intermittent nature so that there is opportunity for cooling at very frequent intervals.

Another point requiring explanation is that the continuous capacity is stated at 30 amperes at 300 volts and 28 amperes at 400 volts. Why these voltages when the motor is a 500-volt motor, and why a different allowable current for each of the two voltages? We have noted in our study of motor control that in actual operation motors are subjected to various voltages depending upon the connections and the resistance in series. The average voltage is, therefore, always less than the maximum, and may be much less when the motors are run a great deal in series. The heating of the motor depends upon the voltage as well as the current, for the reason that the voltage depends upon the speed, other things being equal. If the voltage and speed are low the flux in the armature core reverses less frequently and, therefore, produces little hysteresis loss, and *vice versa*.

On account of the intermittent nature of the load on a railway motor it is not possible to select motors for a given equipment on the basis of heating with continuous load. Such selection can be based only on experience.

Control. The principle of speed control of any constant-potential motor is that the armature conductors, by their motion through the field flux, produce an electromotive force equal to the voltage applied to the brushes less the voltage drop in the resistance of the motor.

EXAMPLE. If a motor has one-half ohm resistance, what will be its counter e.m.f. when operating at 500 volts and drawing 50 amperes from the line?

Solution. The voltage drop in resistance is 50×0.5 , or 25 volts. The counter e.m.f. is, therefore, $500 - 25$, or 475 volts. The armature must rotate at such a speed as to generate 475 volts with this value of current.

Keeping this fundamental principle in mind, it follows that if any factor of the counter e.m.f. be varied there will be a corresponding variation in speed. These factors are shown in the formula for the e.m.f. in a motor armature circuit.

$$e = \frac{n \times \Phi \times p}{t \times 10^8} = E - rI$$

Where e equals counter e.m.f. of motor, in volts; n equals number of armature conductors, in series, between brushes; Φ equals flux under one pole, in lines of force per square inch; p equals number of poles; E equals applied e.m.f., in volts; r equals armature and field resistance; I equals current, in amperes; and t equals time of one revolution in seconds, or $\frac{60}{\text{r.p.m.}}$.

The quantities in this formula which can be conveniently varied are the applied voltage E and the field flux Φ .

In modern practice the first of these methods is the only one used. Before going into detail regarding the first method it may be stated that the two plans formerly used to vary the field flux with a given current in the motor were, (a) to change the number of field turns, and (b) to shunt the field circuit with a resistance circuit to deflect part of the current. Both of these methods have been abandoned for the simpler plan of changing the electromotive force.

The e.m.f. is changed in modern control systems, (a) by inserting resistance in the main circuit and thus cutting down the voltage at the motor terminals. This plan is used only in starting as it is

wasteful of power; (b) by connecting the motors first in series and then in parallel. When the motors are in series the line voltage is divided between them.

Fig. 48 shows the connections which are made by the controller in starting and in running. At the left are given the positions of the controller handle corresponding to the different connections. Next is shown the starting resistance; then the armatures and

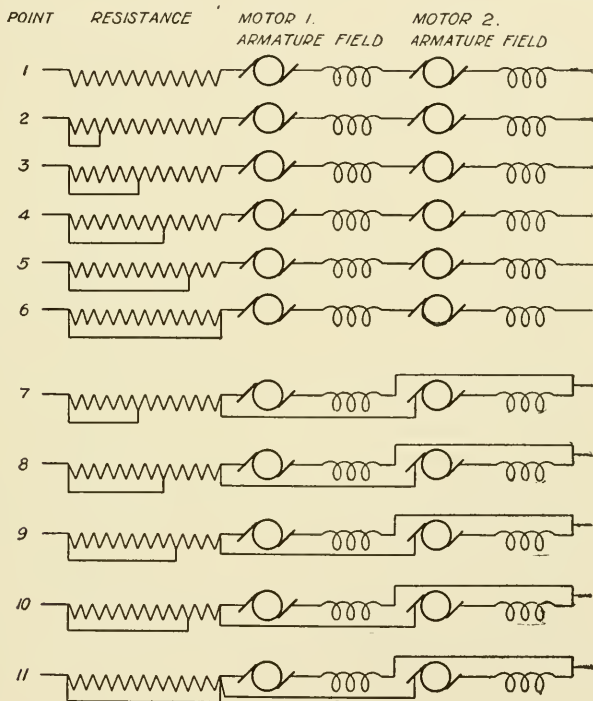

Fig. 48. Controller Diagram

fields of the two motors. The connections on the different points are as follows:

(1) Starting resistance in series with the motors, which are connected in series.

(2) As above, but with part of the starting resistance short-circuited.

(3), (4), and (5) As above, but with more resistance short-circuited on each point.

(6) Two motors in series. This is the slow-speed running position, each motor having one-half the line voltage.

- (7) Motors in parallel with starting resistance.
 (8), (9), and (10) Same as in (7) but with more resistance cut out on each step.
 (11) Motors in parallel. This is the full speed running position.

The two running positions (6) and (11) are in this case the only ones in which the controller should be operated continuously, as it is not only inefficient to waste power in resistance, but the resistance grids are not made with sufficient carrying capacity to stand the motor current for more time than is just necessary to bring the car up to speed.

ILLUSTRATIVE PROBLEMS

1. The 20-ton car used in the problem, page 40, while climbing the 5 per cent grade, has its motors connected in series. If the resistance of each motor is 0.3 ohm, what speed will the car now make?

Solution. The required horizontal effort, which has been assumed independent of speed, is the same as before, 2,400 pounds, or 1,200 pounds per motor. Each motor now gets 250 volts and the current in each motor is the same as before, 80 amperes, which it must be to produce the same torque. The voltage drop in resistance of each motor is $80 \times 0.3 = 24$ volts, so that the counter e.m.f. is $250 - 24$, or 226 volts. The counter e.m.f. of each motor on full line voltage is $500 - 24$, or 476 volts. As all other quantities are the same as before, the speed is proportional to the counter e.m.f. The new speed is, therefore,

$$\text{m. p. h.} = 14.2 \times \frac{226}{476} = 6.75$$

which is slightly less than one-half the former speed.

2. What will be the speed of the car if, while the motors are in parallel, a resistance of 2 ohms is connected in series with them?

Solution. The current per motor is as before, the total current being 160 amperes. This current flowing through 2 ohms produces a drop of 320 volts. The motor voltage is, therefore, $500 - 320$, or 180. The motor counter e.m.f. is $180 - 80 \times 0.3 = 156$ volts. The new speed is,

$$\text{m. p. h.} = 14.2 \times \frac{156}{476} = 4.65$$

Connections in Four-Motor Equipments. Double-truck cars ordinarily have four motors. In this case the principle of connection is the same but the two motors on each truck are treated like each of the two motors in the car just described. Fig. 49 shows the series, or half-speed connections, and Fig. 50 the parallel, or fullspeed, connections. The intermediate resistance positions are as before.

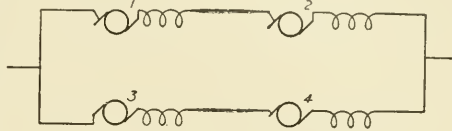

Fig. 49. Motors in Series-Parallel

Reversal of Direction of Motor Rotation. Reversing the direction of the flow of current through a motor will *not* reverse the direction of rotation, because the field current and the armature current reverse at the same time. It is necessary to change the direction of the current either in the field or armature by reversing the terminals of one or the other. The way in which this is accomplished will be explained in connection with the sections on controllers.

ALTERNATING-CURRENT TYPE

One of the important recent developments in electric traction is the adaptation of the alternating current to this work. The induction motor, being inherently a constant-speed motor, is not adapted for railway purposes. The series a. c. motor has practically the same characteristics as the d. c. motor of the same type.

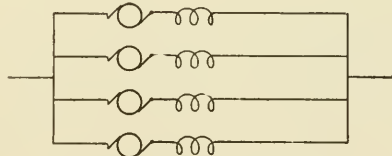

Fig. 50. Motors in Parallel

The direction of rotation of a series motor does not depend upon the direction of the current, hence it would at first appear that a standard d. c. motor should operate upon alternating current. It will not do so successfully, partly because the windings oppose the current with a large reactance. Several important modifications have been necessary in order to adapt the series motor to alternating current. These will be taken up in order.

Reduction of Reactance. As the reactance of a coil depends upon the number of turns, the number of turns is made as small as possible. The effect of this is to reduce the flux under the poles

if all other conditions remain the same. To reduce the effect of the weak field magnetomotive force the air gap is made as short as is practicable, thus reducing the reluctance of the magnetic circuit.

Increase of Armature Turns. To produce the necessary torque requires more armature conductors in a weak field as compared with a strong one, the torque being proportional to both the flux and the number of conductors (the current remaining the same). The armatures of series a. c. motors have, therefore, more ampere-turns, or magnetomotive force, than those of d. c. motors; in fact they are several times as strong. This m.m.f., if not corrected, would distort the field badly and produce sparking. The device for neutralizing the armature is, therefore, essential.

Neutralization of Armature Magnetomotive Force. Surrounding the armature and carried by the field magnet, is a winding nearly similar to that of the armature, carrying the same current—the two being connected in series—in an opposite direction. The magnetomotive force of this winding is slightly greater than that of the armature for the purpose of, *first*, neutralizing the latter, and, *second*, producing a field in which commutation can go on satisfactorily.

Increase in the Number of Poles. As the poles are weakened by the reduction in the number of turns on each it is desirable to have as many as possible consistent with good mechanical and electrical design. The number of poles is, therefore, always greater in a. c. series motor than in d. c. motors, the latter almost invariably having four poles.

The Use of Laminated Field Cores. As the flux in the field of the motor is alternating, it is necessary to use laminated iron in all parts of the field structure which carry the flux. If this were not done there would be a great waste of power in eddy currents, which would also heat the motor.

The Use of High-Resistance Commutator Leads. A difficulty not yet mentioned, and one of the most serious of all, is due to the fact that the coils which are, for a short time, short-circuited by the brushes, are in an alternating field. They act as would the secondary of a transformer if short-circuited for the same length of time. As it is necessary to short-circuit the coils at the time of reversal of the current under the brushes, the "transformer" short-circuit current cannot be entirely eliminated by any convenient

plan. The practice in this country at present is to insert high-resistance conductors or leads between the commutator bars and the coil. Fig. 51 shows bars *b*, *c*, and *d* connected by the brush and the corresponding coils short-circuited. Current flows in these coils by transformer action, as explained, passing through the high-resistance leads, which keep the current down to a value which will not overheat the winding. The high-resistance leads are in action only while the coils are under the brush, no current, in this case, passing out through bars *b* and *c*.

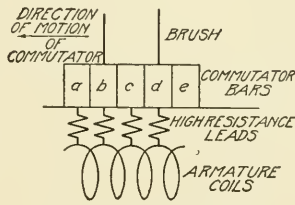

Fig. 51. High-Resistance Commutator Leads

Use of Low=Motor Voltage. The e.m.f. at the motor terminals in series a. c. motors is about one-half that used in d. c. motors. This practice follows from the considerations already mentioned. A large counter e.m.f. can be produced either in a strong field, or by many armature conductors, or both. As has been shown, the field must be weak, and while the armature conductors are numerous it would be difficult to use enough to enable the motor to generate 500 or 600 volts. The voltage is, therefore, stepped down by means of transformers on the cars. This permits the use of high trolley voltages, which may be as high as 11,000 or more, if desired.

Frequency for Alternating-Current Series Motors. As frequency is one of the factors of reactance, the lower the frequency the better. The frequency is, therefore, made as low as possible, the limit being fixed by other parts of the system, such as the transformers and generating apparatus.

CONTROLLERS

After the principles of series motor control are mastered, the student is in a position to understand the construction of controllers. The function of the controller is to make the connections called for in the diagrams without unnecessary sparking in the controller contacts. There are two general forms of controller in use:

(a) The *manual*, or *cylinder*, controller, used on cars of small and moderate size, when operated singly or with trailers. (A trailer is a car drawn by another and not equipped with motors.)

(b) The controller of the *multiple-unit* type, in which the motorman does not directly make the motor connections. These are made by circuit

breakers or "contactors" which are operated either by solenoids, General Electric Company, or by air cylinders and pistons, Westinghouse Electric and Manufacturing Company. In the General Electric plan the motorman controls the current in the solenoids. In the Westinghouse system he controls the current in electromagnetic valves which, in turn, control the supply of air to the contactor cylinders.

Manual Controller. A typical cylinder controller is illustrated in Fig 52. It comprises the following essential parts:

(a) The main cylinder at the left, consisting of an iron drum, carrying copper contact segments, and rotated by the main con-

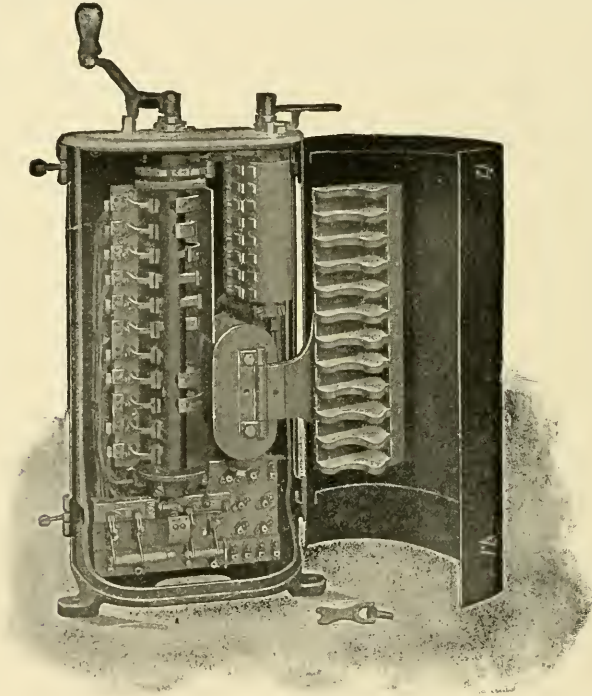

Fig. 52. K-10 Controller

troller handle above. Some of the copper segments are insulated from the drum, others are not. At the top of the drum and rotating with it is a notched wheel (star-wheel) against which a strong spring presses a roller. The roller and star-wheel tend to hold the drum in any position to which it is rotated by the handle.

(b) The contact fingers at the extreme left. These are copper arms of the form clearly shown in the figure, and they are mounted on

adjustable spring supports which press them firmly against the contact segments. The connections to the motor circuits are made through these contact fingers.

(c) The reversing cylinder, shown in the upper right-hand corner. This is a drum of insulating material carrying segments connected to the motor armature and field circuits. As the name implies its function is to change the

relative direction of the current in the two circuits,

this being necessary to produce reversal, as just explained.

(d) The "blow-out" magnet. A large magnet, connected in the main circuit, produces a strong field from back to front of the controller, so that all contacts are broken in this field. The field produces a powerful mechanical force on the arcs just as it does on any other conductor carrying current. The arcs are thus instantly ruptured. The poles of the magnet are spread out to increase the extent of the field. One pole is shown in Fig. 52 hinged on the front of the blow-out magnet.

(e) A set of partitions of fire-resisting material (asbestos composition) which separate the contact segments on the main drum and thus prevent arcs from jumping from segment to segment.

(f) A terminal board and switches, shown at the bottom of the controller case. The former contains terminal lugs connected with the controller fingers. It renders the controller self-contained, so that when the car wiring is disconnected, the controller may be removed without disarranging the interior wiring. The switches are provided to permit the cutting out of the circuit of one or both motors.

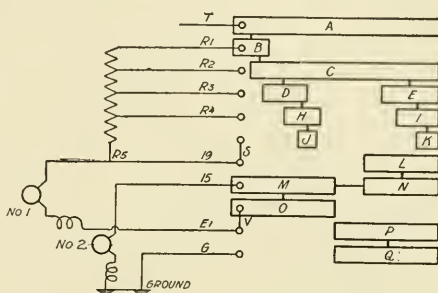

Fig. 53. Development of Controller Connections—Motors in Series

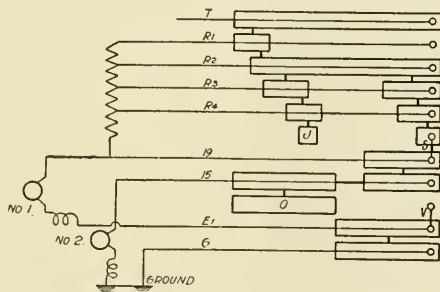

Fig. 54. Development of Controller Connections—Motors in Parallel

(g) An iron case, arranged with hinged front which may be readily opened for inspection. As indicated in the figure all interior parts are easily accessible when the front is open.

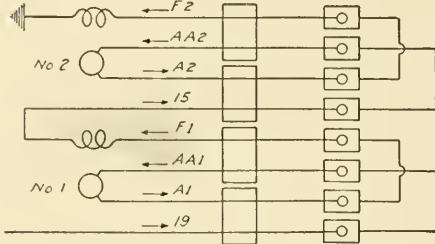

Fig. 55. Forward Position of Reverse

In the operation of the controller the handle is rotated, bringing various segments under the contact fingers. Fig. 53 shows the connections in position 1, the contact fingers being represented by small circles. The cylinder is represented as if cut and laid out flat, or in the terms used in drawing, it is "developed". Segments A to K are not insulated from the drum, hence they are connected together by it. In this position the route of the current is as follows: Trolley to segment A; through segment B and wire R to resistance; through motor No. 1 to wire E; through insulated but connected segments O and M; through wire 15; through motor No. 2 to ground.

In successive positions of the controller handle, the resistance is gradually cut out, then the motor connections are changed to parallel with resistance in series, next this resistance is gradually cut out, until finally the full parallel position shown in Fig. 54 is reached.

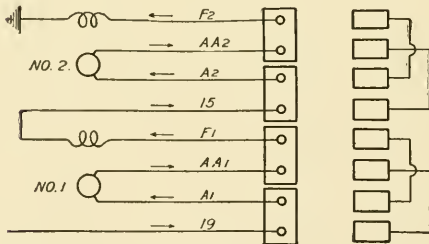
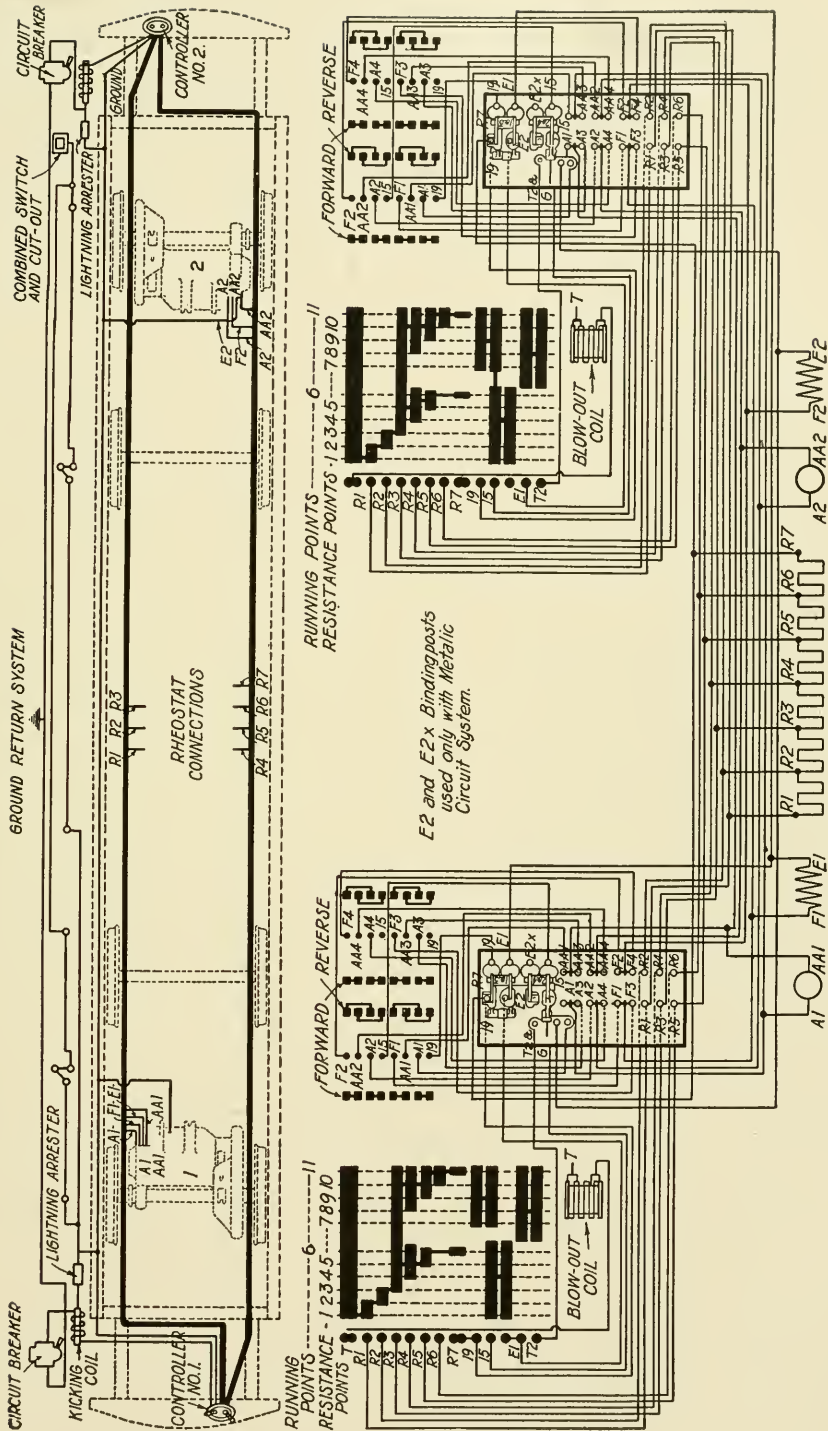

Fig. 56. Reverse Position of Reverse

The details of the reverser connections are shown diagrammatically in Fig. 55 which represents the development of the reverser cylinder. The field coils and armatures of the two motors are shown at the left and to the right are two sets of copper segments. In the forward position shown in Fig. 55, the arrows show the direction of the current, right and left alternately, beginning at the bottom. In the reverse position, Fig. 56, the current is reversed in both armatures, remaining in the same direction in the field circuits.

The student can obtain practice in reading wiring diagrams by



E2 and E2x Binding posts used only with Metallic Circuit System.

Fig. 57. Wiring for K-6 Controller

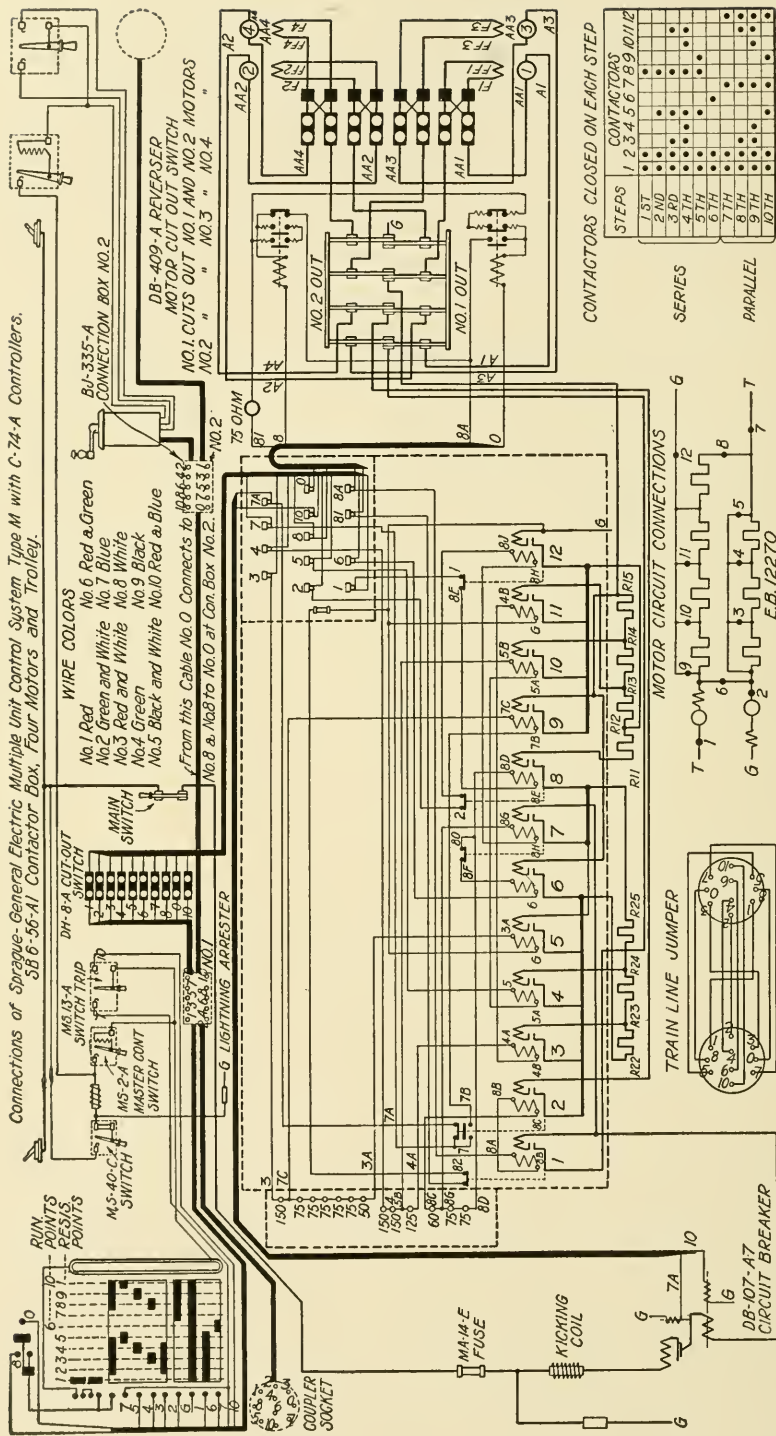

Fig. 58. Wiring for Diagram Sprague-General Electric Non-Automatic Control

a study of Fig. 57, which is a copy of one of the blueprints furnished with motor equipments. While this diagram in all details does not exactly correspond with the controller shown, the connections are the same. The upper part of this figure shows the relative positions of motors, controllers, rheostats (or resistance grids), cables, and details. The cables are canvas-covered bundles of wires corresponding to those shown connected to the controller fingers, Figs. 57 and 58.

MULTIPLE-UNIT CONTROLLER

The multiple-unit controller differs from the manual controller in that the motor connections as shown in the diagrams are made by circuit breakers which can open circuits carrying very heavy currents. A second very important feature of this system, as the name indicates, is the operation of all of the motors in a train from one point. A third advantage is the ease with which the accelerating current, which is always much larger than the running current, can be limited. There are two principal systems of control in use in this country, both of which will be described briefly.

Sprague-General Electric Control

In the manual controller the contacts are made between contact fingers and segments on the drum. Each finger and its accompanying segment constitute a switch which is opened and closed by the rotation of the controller handle. The controller illustrated in Fig. 52 contains 11 such switches. If these simple and crude switches be replaced by modern circuit breakers, operated by solenoids

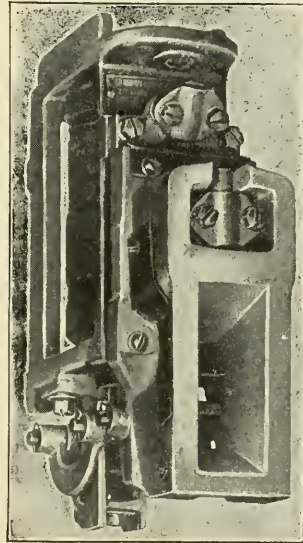

Fig. 59. Sprague-General Electric Contactor

carrying small control currents, there results one of the essential features of the Sprague-General Electric Control. Before taking up a study of the circuits in this system it is desirable first to become acquainted with the appearance and purpose of each of the component pieces of equipment. Reference to Fig. 58 regardless of the wiring, shows that the following devices are used.

Contactors. The circuit breakers in the form especially developed for traction work are called *contactors*. Such a contactor is shown in Figs. 59 and 60. It consists of a coil of fine wire sur-

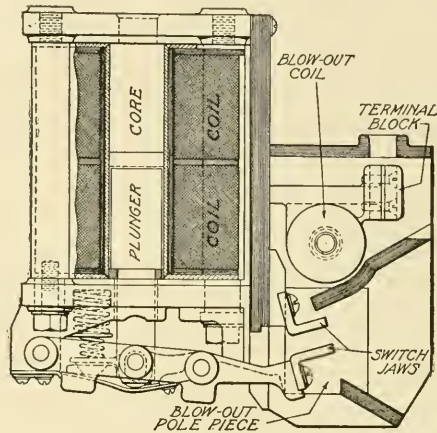

Fig. 60 Sprague-General Electric Contactor Diagram

rounding a movable plunger and capable of exerting a powerful pull thereon. The lower end of the plunger is attached to a switch arm on the end of which is a copper contact finger which is one end of the

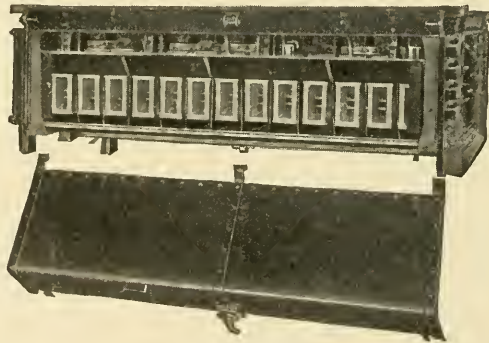
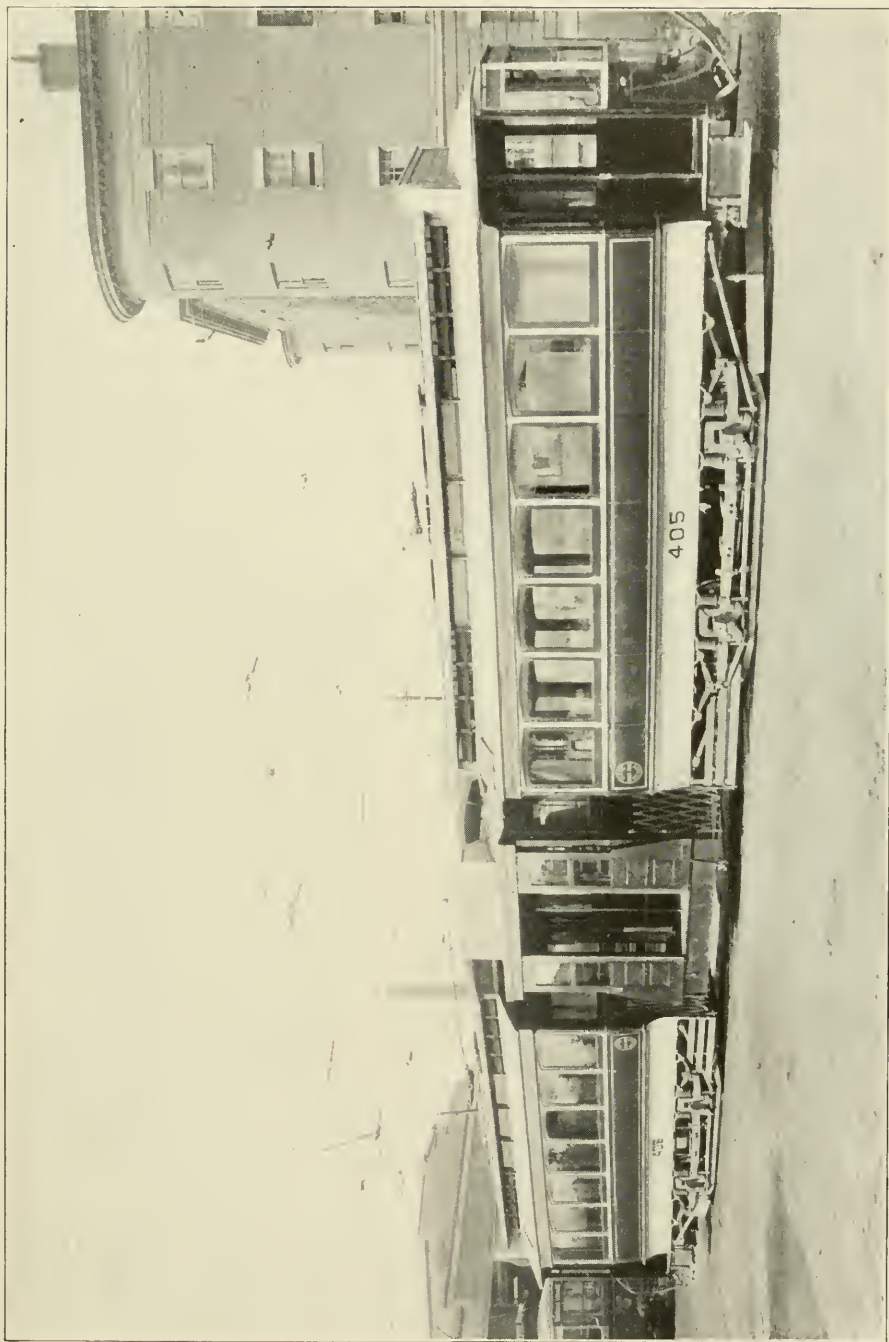

Fig. 61. Group of Sprague-General Electric Unit Switch

circuit. When the solenoid is energized the contact piece is pulled into firm contact with a stationary finger which forms the other terminal of the circuit and the main circuit is thus closed. When no current flows in the coil a spring restores the switch arm to its original



NEW TYPE OF "ARTICULATED" STREET CARS OF THE BOSTON ELEVATED RAILWAY

position, thus opening the main switch. The circuit-breaking contacts are enclosed in a chamber of fire-resisting material of the form shown, thus confining the burning action of the arc to the renewable contact fingers. The arc is extinguished by the magnetic blow-out principle already described. A small coil is located just above the contact fingers but separated from them by a fireproof partition. This coil is horizontal and it lies just back of the terminal block shown in Fig. 60. Its poles are extended by two iron strips, one on each side of the fire-proof chamber. One of these pole strips appears in the figure. The magnetic blow-out field exists between the two poles in a horizontal direction. The several contactors comprising the equipment of a car are placed in a sheet-iron box which is accessibly located under the car, Fig. 61.

Interlocks, or Auxiliary Contacts. It will be noted that above several of the contactors in Fig. 58 are located small auxiliary contacts in the control circuit. These are operated by the motion of the contactor, as shown diagrammatically in Fig. 62. This figure corresponds to the interlocks on contactor 2. The auxiliary contact switch

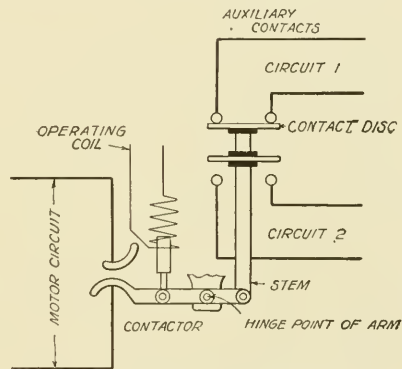

Fig. 62. Diagram of Sprague-General Electric Interlock

consists of the stationary terminals and a movable stem attached at one end to the contactor lever. The stem carries one or more insulated copper contact disks. In Fig. 62 the contactor is shown open and auxiliary circuit 1 closed. When the contactor closes by means of the current sent through its operating coil, auxiliary circuit 1 is opened and 2 is closed. In this manner any number of auxiliary circuits can be controlled.

Control=Circuit Cut-Out Switch. The control-circuit cut-out switch is a simple cylindrical switch with a row of segments and contact fingers. The rotation of this cylinder opens and closes all of the control circuits at one time.

Main Circuit Breaker. The main circuit breaker is a modification of the type used on station switchboards. In the latter

there is a switch opened by a spring, the contacts being located in a blow-out field. The switch is held closed by a trigger which is tripped by a solenoid carrying all or part of the line current. The circuit breaker may be closed by hand. In the car circuit breaker shown diagrammatically in Fig. 58, the setting of the switch is done by means of a solenoid, represented vertically. The breaker may be tripped either by the heavy-wire horizontal coil in the main circuit, or by the fine-wire horizontal coil in the control circuit. The left-hand heavy-wire horizontal coil furnishes the magnetic blow-out field.

Reverser. The place of the reversing cylinder of the manual controller is taken by a device known as the *reverser*, Fig. 63, which

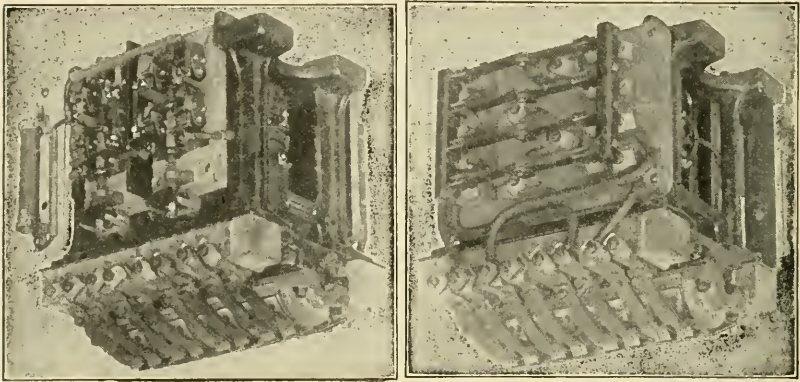

Fig. 63. Front and Back View of Sprague-General Electric Reverser

operates on exactly the same principle. The difference is that, whereas the cylinder is rotated by hand, this one is rocked by two solenoids, one acting in each direction.

Master Controller. The current for operating the contactors comes from the trolley wire and is distributed to the several solenoids at the proper instants through a *master controller* similar to that illustrated in Fig. 64. This contains a drum similar in construction to the main drum of a cylinder controller, but much smaller in diameter as the currents to be carried are small. The segments and contact fingers are of the standard form. This master controller operates the contactors and the reversers.

Train Line. The control current is carried in a bundle of wires or cables known as the *train line* because it passes from one motor

car to another, connecting all of the switch groups or sets of contactors in the train. The train line terminates at each end of each car in coupler sockets which are bridged across between cars by flexible couplers.

Non=Automatic Control. The essential features of the non-automatic multiple-unit control are not essentially different from those of the cylinder control. If the student will keep this fact clearly in mind and will remember that the rather considerable number of wires which he sees in the diagram belong mostly to the control circuits, he should not find any great difficulty in following the connections. We shall go through these step by step, for in no other way can the diagram teach the lessons which we wish to learn from it.

Motor Circuits. In the diagram, Fig. 58, the control circuits are shown by light lines and the motor circuits by heavy lines. The twelve contactors are shown in a row in the lower part of the diagram, and numbered consecutively from 1 to 12. By means of them the connections are made as in the small diagram and the contactor table, both of which are in the lower right-hand corner.

The diagram is for a four-motor equipment, but as each pair of motors can be treated as a single motor—the motors of the pair being connected permanently in parallel—but two motors are shown in the small diagram. The contactor table enables us to determine at a glance which contactors are closed at each of the ten master controller positions. There are 12 vertical and 10 horizontal columns in the table. By reading horizontally along any lines corresponding to a controller step, we note by the positions of the dots the number of the contactors in operation. For example on step 1, contactors 1, 2, and 8 are closed, etc. The motor circuit diagram shows the locations of the various contactors in the motor circuits. The locations are as follows:

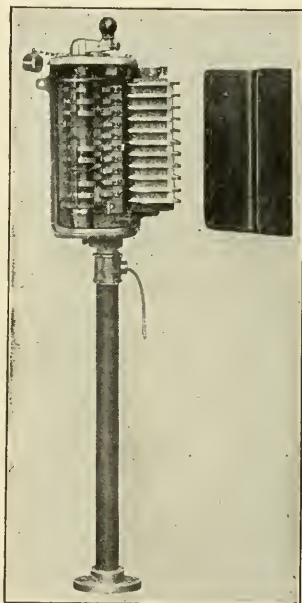

Fig. 64. Sprague-General Electric Master Controller

- (1) Between trolley *T* and one motor (or pair of motors).
- (2) Between the second motor and the resistance grids.
- (3) In the jumper or short-circuiting wire around a resistance grid.
- (4) In the jumper around the second resistance grid.
- (5) In the jumper around the three lower resistance grids.
- (6) In the bridge connection between the two motor circuits.
- (7) In the trolley circuit of the lower motor.
- (8) In the wire connecting the two sets of resistance grids.
- (9) Same as 5 but for the upper grids.
- (10) Same as 4 but for the upper grids.
- (11) Same as 3 but for the upper grids.
- (12) In the ground circuit of the upper motor.

The combinations shown in the contactor table produce the following connections:

STEP 1. Trolley—motor No. 1—all resistance grids—motor No. 2—ground.

STEP 2. Trolley—motor No. 1—upper four resistance grids—motor No. 2—ground.

STEP 3. Trolley—motor No. 1—three sections of upper grids—motor No. 2—ground.

STEP 4. Trolley—motor No. 1—two sections of upper grids—motor No. 2—ground*.

STEP 5. Trolley—motor No. 1—one section of upper grids—motor No. 2—ground.

STEP 6. Trolley—motor No. 1—motor No. 2—ground. This is the series, or low-speed, running position, each motor having half voltage.

STEP 7. Trolley (lower right-hand corner)—lower resistance grids—motor No. 2—ground.

Trolley (upper left-hand corner)—three sections of upper resistance grids—ground.

STEP 8. Same but with one grid cut out in each motor circuit.

STEP 9. Same but with another grid cut out in each motor circuit.

STEP 10. Motors in parallel with no resistance in circuit. This is the parallel, or high speed, running position, each motor having full voltage.

Passing next to the motor circuits in the main diagram, shown by heavy lines, the above combinations should be traced out step by step. In order to make sure that the student understands the meaning of the several pieces of apparatus shown in these circuits, one of the combinations is followed through.

*The student will naturally inquire why in positions 3 and 4 he finds contactors 3 and 4 closed when the grids which they short-circuit are already short-circuited by 5. The reason for this is that the operating coils of 3 and 11, and 4 and 10 are permanently connected in series as they operate together in the parallel position of the controller. No harm is done by allowing them to close in the series position and the wiring is simplified by the arrangement.

The current comes from the trolley shown at the top, through the main switch and the fuse, to the kicking coil. This is a coil of low resistance but, like all coiled circuits, it opposes to lightning discharges a strong counter e.m.f., forcing them to go through the lightning-arrester to the ground. From the kicking coil the current passes through the circuit breaker and through contactor 1. The route from here on is determined by the controller position, but to this point it is the same for all positions. Take, first, step 1. From contactor 1 the current goes through the following circuits: center of motor cut-out switch, branching to the armatures of the two motors forming a pair; from the armatures through the reverser to the corresponding field windings; back to the motor cut-out switch; to the right-hand end of the resistance grids; through contactor 8 to the left-hand group of resistance grids; through contactor 2 to the motor cut-out switch again; through the armatures and fields of the other pair of motors; to the ground. This corresponds exactly to the circuit previously traced out for step 1.

Some additional explanation of the cut-out switch and the reverser connections may be helpful before going farther. The cut-out switch is a double four-pole switch, the upper and lower parts each controlling two motors. By opening one or the other of the switches, the corresponding two motors can be cut out of service and the car can be operated in an emergency by the others. This arrangement is also convenient in testing. As has been explained the function of the reverser is to reverse the direction of the current in the field or armature windings but not in both. In this case the field terminals are the ones reversed.

In a manner similar to the foregoing, the student should follow through the several combinations of motor circuits corresponding to the other nine controller steps.

Control Circuits. In the upper left-hand corner of the diagram is shown the developed diagram of the master controller. The steps are represented by the vertical dotted lines. At each step the corresponding dotted line is considered as brought under the row of controller fingers at the left.

On step 1 the control current takes the following route: Trolley; switch and fuse, beyond which is a lightning path to ground through the lightning arrester; kicking coil; master controller switch;

magnetic blow-out in master controller; upper four fingers on controller; reverser switch, which may be assumed to be pushed to the left; by wire *8* which goes into the cable emerging at terminal board *1*; thence to the cut-out switch; then to the main connection board; and finally to the upper reverser operating coil. From the reverser coil—which as the name indicates throws the reverser over to the corresponding position—the path is through the reverser interlock, at the right of the reverser coil by way of wire *8A* to the operating coil of contactor *1*; thence by wire *8B* to the operating coil of contactor *2*; thence by wire *8C* to the resistance coils; thence by *8D* to the operating coil of contactor *8*; thence by *8E* through the interlock on contactor *12*—making it impossible for *12* and *8* to be closed at the same time as they would practically make a short-circuit if both closed at once—through wire *1* to the master controller and to ground.

In following the above route the student will have noted that the wires are plainly lettered and numbered so that with a little practice there is no danger of confusion. The wire has the same number over practically the entire route, the letter changing as the circuit passes through each piece of apparatus.

On master controller step *1* there are several auxiliary operations with which the student should be familiar before passing to the next.

To the right of the master controller switch is represented the switch which is used to set and trip the main circuit breaker, shown in the lower left-hand corner. The circuit breaker contains four windings: (1) the upper horizontal heavy-wire coil, the blow-out coil; (2) the lower heavy-wire coil, which opens the breaker on over-load; (3) the vertical fine-wire coil, which sets the breaker; and (4) the horizontal fine-wire coil, provided for hand-tripping of the breaker. When the circuit breaker operating switch is thrown to the left, it energizes the setting coil on the breaker by way of wire *7* through the interlock on contactor *2*, wire *7A*, setting coil on breaker, ground. When the switch is thrown to the right it trips the breaker through wire *10*, tripping coil and breaker, ground.

A second point to be noted is that when the reverser has operated by means of current sent through its operating coil, its interlock breaks the connection between wires *8* and *8A* and establishes a new connection between *8* and *81*, and by way of the interlock on

contactor 1 and wire 82 to ground. This is the holding position of the reverser in which a small current is sufficient to hold the arm in place.

The student should now follow through the control circuits on the other steps, noting particularly the action of the interlocks in preventing two circuits from being energized at the same time when trouble would be caused if the circuits were not so protected.

Automatic Control. As was stated earlier, one of the great advantages of the multiple-unit system is that control of acceleration can be arranged without great difficulty. Such control is beneficial in several ways: (1) By limitation of starting current, the strain on the motors is kept within a reasonable amount; (2) the corresponding demand for current from the power house and line is reduced; (3) the acceleration of the car is rendered uniform, insuring the comfort of the passengers when the car starts.

The fundamental principle of the automatic control is that automatic means are provided for limiting the amount of current which can be drawn from the line. This is accomplished by a current-limiting relay of the general form shown in Fig. 65. The relay has two windings, one a fine-wire coil in the control circuit, the other a heavy copper strap winding of a few turns in the main motor circuit. Below is an interlock of the kind already described and above is a small cylinder and a piston known as a "dashpot" which retards the upward motion of the plunger of the relay.

A wiring diagram for a modern automatic control is given in the appendix part IV, page 282. It is not very different from the preceding system and will not be followed through in detail. The number of contacts and the combinations of motor circuits produced by them are the same as in the preceding case. There are, however, more gradual resistance steps. These motor circuits can be followed

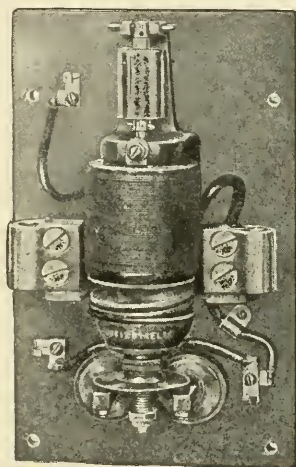

Fig. 65. Sprague-General Electric Current Limit Relay

from the motor circuit diagram in connection with the contactor table. The master controller is somewhat different from that previously described, in that the reverse direction of the reverser is secured by a motion of the master controller handle in the opposite direction from that which produces forward motion. The diagram shows four forward positions of the master controller—two each on series and parallel—and two reverse positions.

A much greater use of the interlock principle is used in the automatic control and it is upon this feature that the student should concentrate particular attention. Most of the auxiliary switches used have four pairs of contacts, the purposes of which will be ex-

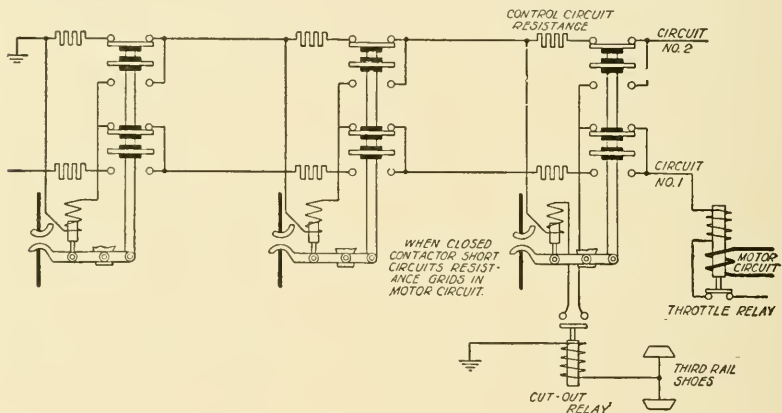

Fig. 66. Diagram of Interlocks, Sprague-General Electric Automatic Control

plained. The number of these at first appears confusing but, as the same general principle underlies the operation of them all, this complexity is only apparent.

The operating principle of the automatic acceleration will be studied with the aid of Fig. 66. In this figure are represented three contactors, each with four pairs of auxiliary contacts. These contactors, when closed, cut out sections of resistance grids and thus increase the current in the motor circuit. The purpose of the scheme is to have these contactors close automatically one after the other, with sufficient intervals between to allow the increasing counter e. m. f. of the motors to keep down the current. This is as if a motor-man, in rotating an ordinary cylinder controller handle, were com-

pelled to wait on each notch until the current fell to a predetermined value.

The purpose is accomplished by means of the *throttle relay* and the *interlocks*. The throttle relay has, as shown in Fig. 66, two windings, one in the main motor circuit and one in the control circuit. The current in the control circuit coil cannot open the relay alone but when the motor current rises above a predetermined amount the relay opens. In the figure, parts of two of the control circuits are shown. These wires are connected to the trolley through the master controller. Either of them may, therefore, supply current when connected to the ground. With the conditions as shown in Fig. 66, current passes from wire 2 through the auxiliary switches and control resistance coils. If the motor current is not sufficient to open the throttle relay, current passes from wire 1 through the throttle relay, the auxiliary contacts, the cut-off relay (closed whenever the third-rail shoes are alive), the operating coil of the right-hand contactor, and the control circuit resistance coils to ground. The contactor closes and short-circuits a motor-circuit resistance grid and, presumably, increases the motor current sufficiently to open the throttle relay. As long as the throttle relay remains open, no more resistance can be cut out as the next contactor cannot close. As soon as the motor current falls again to the proper value, the throttle relay closes and the second contactor automatically goes through the same operations as the first did before. Any number of resistance contactors can be operated on this principle. From the functions performed by control circuits 1 and 2, they are called the "accelerating" circuits, 1 being the *lifting* circuit, and 2 the *holding* circuit. The reason for the use of the words "holding" and "lifting" is apparent from the fact that current through 1 closes the contactors and that through 2 holds them closed.

The automatic feature just described is the main difference between this type of control and the one discussed in detail. With the fundamental principle thoroughly understood the student will be able to trace out the circuits if he needs to do so in his practical work. For those who wish practice in tracing out the circuits in connection with these studies a very recent diagram is given in the appendix Part IV, page 282.

Westinghouse Unit Switch Control

The Westinghouse Company has developed a system of multiple-unit control which is, in many ways, similar to the Sprague-General Electric system. An essential difference is that the energy for operating the unit switches is supplied by means of compressed air instead of the electric current. This involves many differences in detail. The compressed air is controlled by electro-pneumatic valves, current for these being supplied through a train line as in the previous case. The essential parts of the system may be summarized as follows:

(1) A group of unit switches or circuit breakers operated (through electro-pneumatic valves) by compressed air, which in turn is operated by

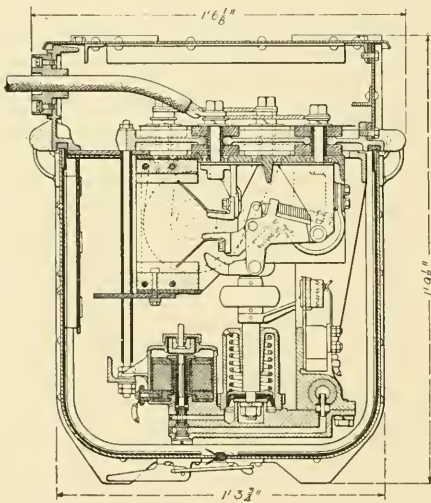

Fig. 67. Cross-Section of Westinghouse Unit Switch

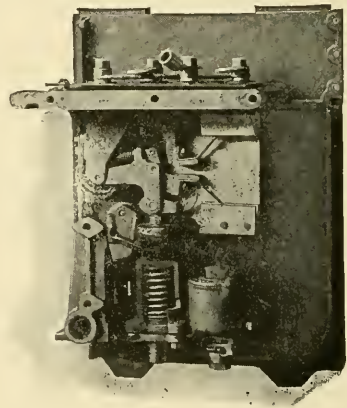

Fig. 68. View of Westinghouse Unit Switch

means of a multiple-wire control circuit (as in the Sprague-General Electric control).

(2) A train line and set of control circuits, with a master controller by means of which the operating coils of the electro-pneumatic valves are energized in the proper combinations by current drawn from the third-rail shoes.

(3) A piping and reservoir system by means of which the unit switches and reservoir are operated.

The remaining parts are not essentially different from those of the other system.

Unit Switch. The unit switch is shown in cross-section in Fig. 67. Compressed air enters through the pipe shown in section in the lower right-hand corner and passes to the valve through the small passage. When the coil of the valve is energized, the air is

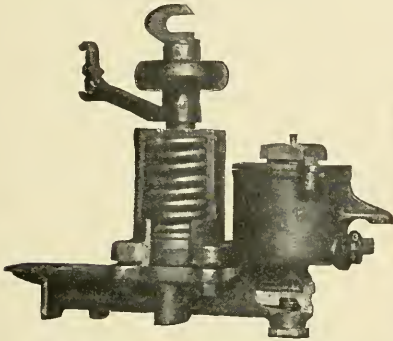

Fig. 69. Westinghouse Unit Switch Cylinder and Magnet Valve

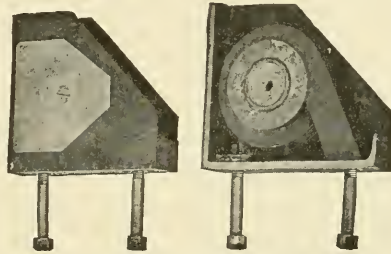

Fig. 70. Details of Blow-Out Coils, Westinghouse Unit Switch

allowed to enter at the bottom of the cylinder and it pushes the piston upward, against the resistance of the coiled spring, and closes the switch. When the exciting circuit is opened the supply of air

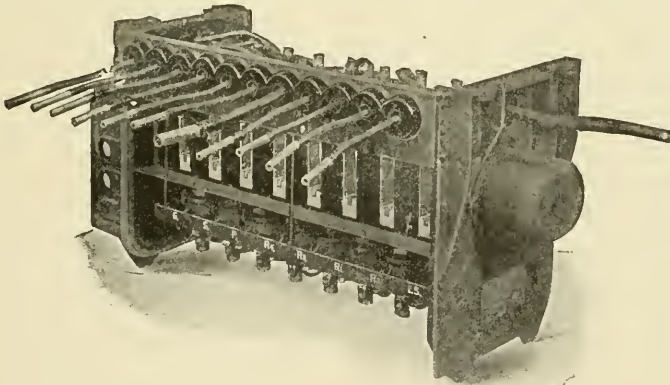

Fig. 71. Group of Unit Switches, Westinghouse System

is cut off and the air in the cylinder is allowed to escape. The switch is then opened by the spring. The arc is broken in a magnetic field produced by a magnet the end of which is shown dotted in the figure. Fig. 68 is a picture of the unit switch with the sides of the box, the arc shute, the cylinder, and the valve cut away to show the

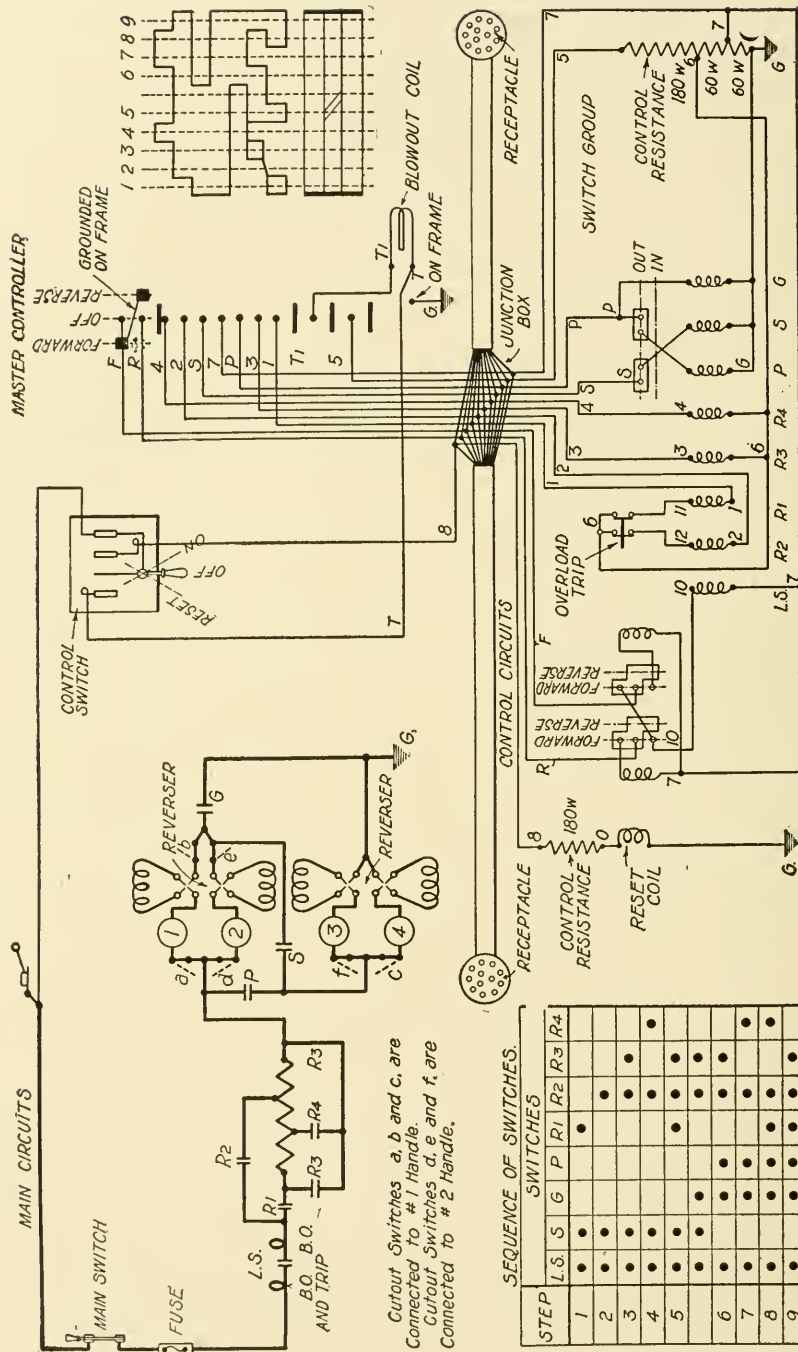

Fig. 72. Wiring Diagram, Westinghouse Multiple-Unit System

working parts. Figs. 67 and 68, taken together, should give a clear idea of the operation of the valve. An enlarged view of the cylinder and magnet valve in Fig. 68 is given in Fig. 69. Details of the blow-out coil are shown in Fig. 70. The appearance of the switch group is given in Fig. 71.

Control and Motor Circuits. The control and motor circuits are shown in simplified form in Fig. 72. The main circuits are in the upper left-hand corner and the control circuits are in the lower right-hand corner. In the lower left-hand corner is a table showing the sequence of switches corresponding to the several series and parallel positions. For simplicity, in the diagram the operating

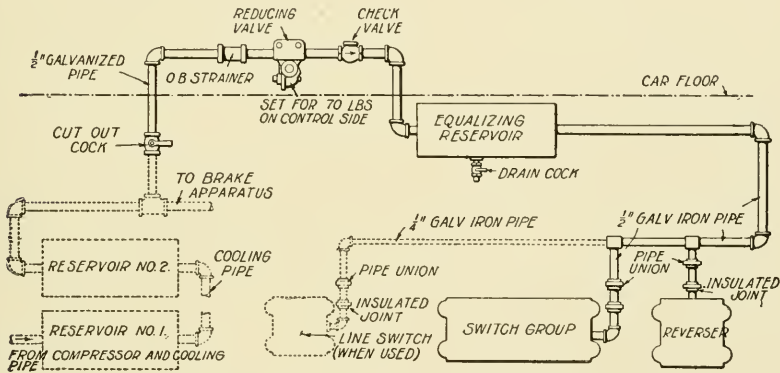

Fig. 73. Piping Diagram, Westinghouse Multiple-Unit System

coils of the unit switches are separated from the corresponding contact fingers. They may readily be identified by the designating letters and figures. As the details are the same as in the Sprague-General Electric system, the student will be able to trace out the circuits without further assistance, referring to the previous explanations if necessary.

Air Supply. As all cars large enough to warrant the use of the multiple-unit system are also provided with air brakes, there is ample air supply for the control system. This air is drawn from the brake reservoirs shown dotted in Fig. 73 and flows through a cut-out cock, a strainer, a reducing valve, which lowers the pressure, and an equalizing reservoir, which prevents reduction of pressure as the apparatus is operated, to the switch group and reverser.

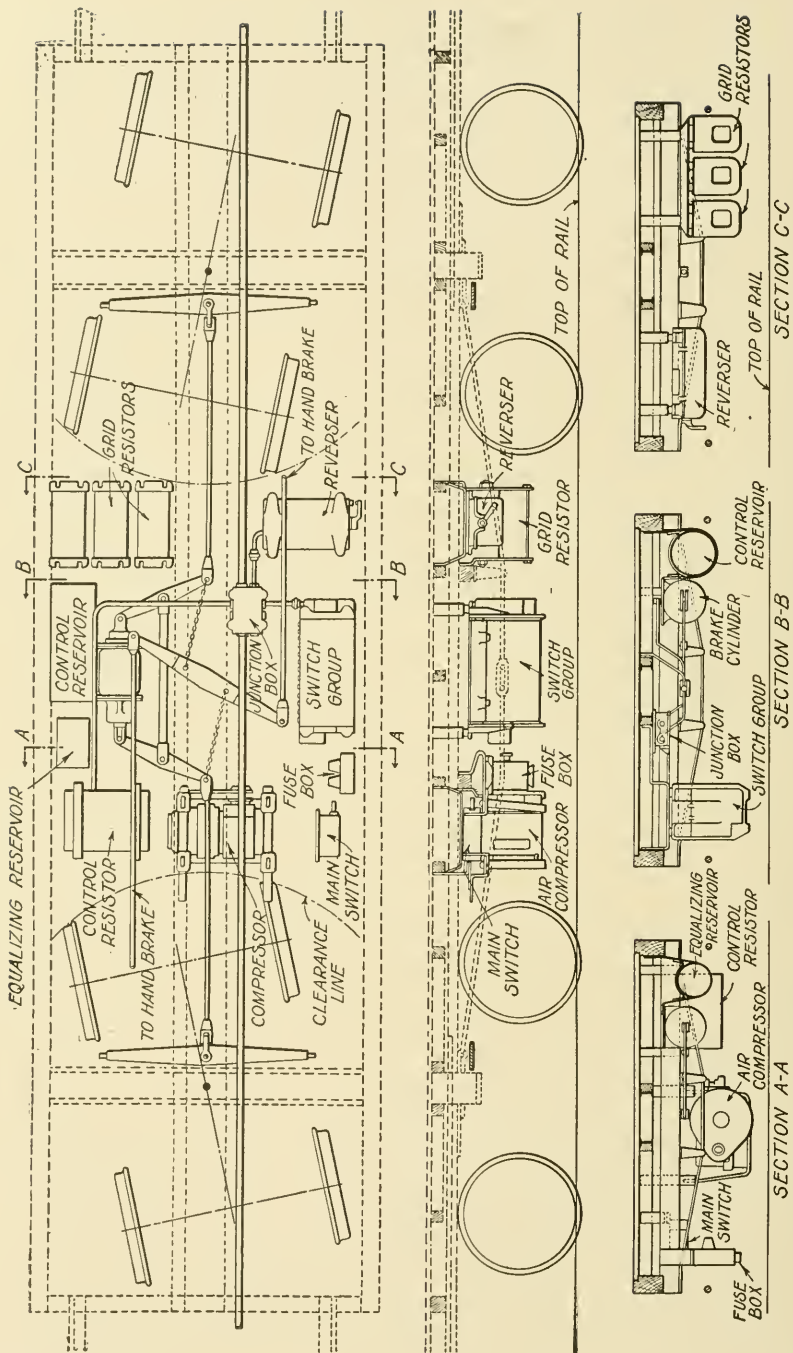

Fig. 74. Diagram of Apparatus Under Car, Westinghouse Multiple-Unit System

The location of the various pieces of the equipment is shown in Fig. 74, which also contains other interesting information regarding

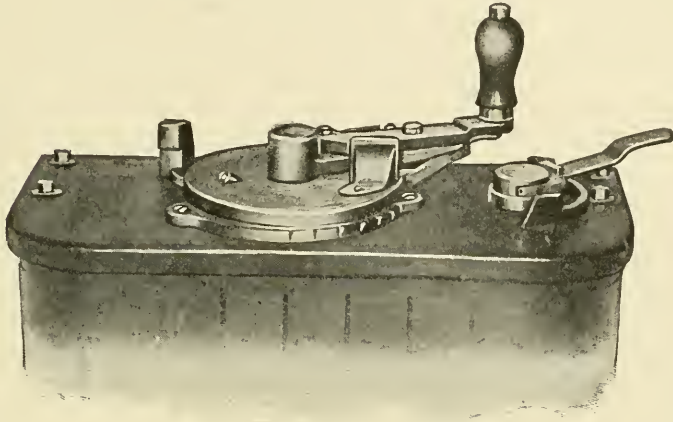

Fig. 75. Automotoneer in Place

matters already taken up in detail and of others still to be considered. The figure indicates how carefully all of the space under the car floor must be utilized in order to accommodate all of this apparatus.

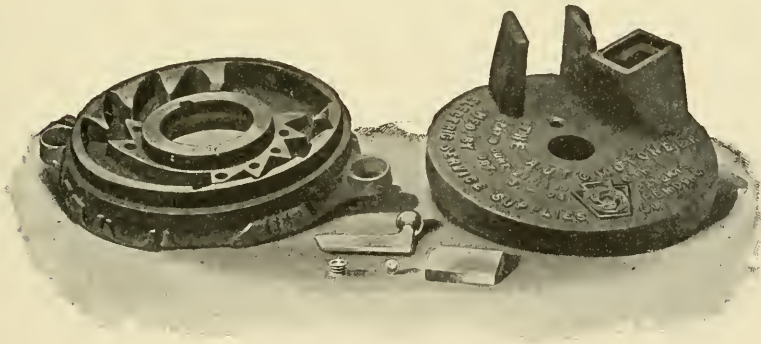

Fig. 76. Automotoneer Parts

PREVENTING OF FAST FEEDING OF MANUAL CONTROLLERS

A large part of the difficulty in maintaining equipments results from too rapid acceleration. Various devices have been used to prevent this. The multiple-unit control readily admits of automatic acceleration, but this is possible also with manual controllers.

Automotoneer. A simple mechanical device for this purpose is the automotoneer, illustrated in Figs. 75 and 76. This is mounted on the top of the ordinary controller. It consists of two main parts, one stationary, the other being rotated by the controller handle. The stationary part contains a zigzag groove, in which plays a movable tongue or pawl carried by the movable part. As the handle is rotated the pawl catches in the angles of the groove and allows the

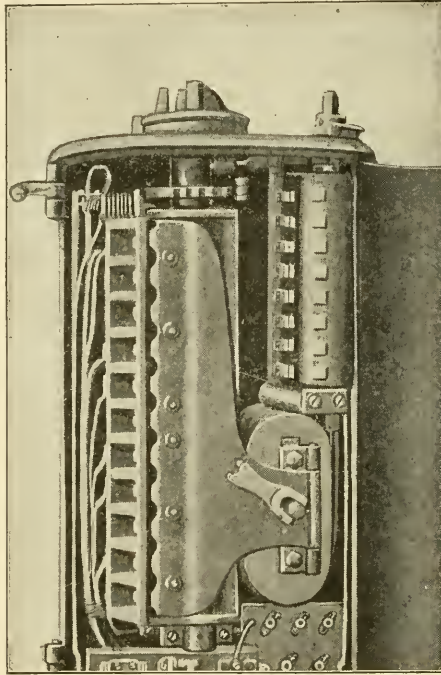
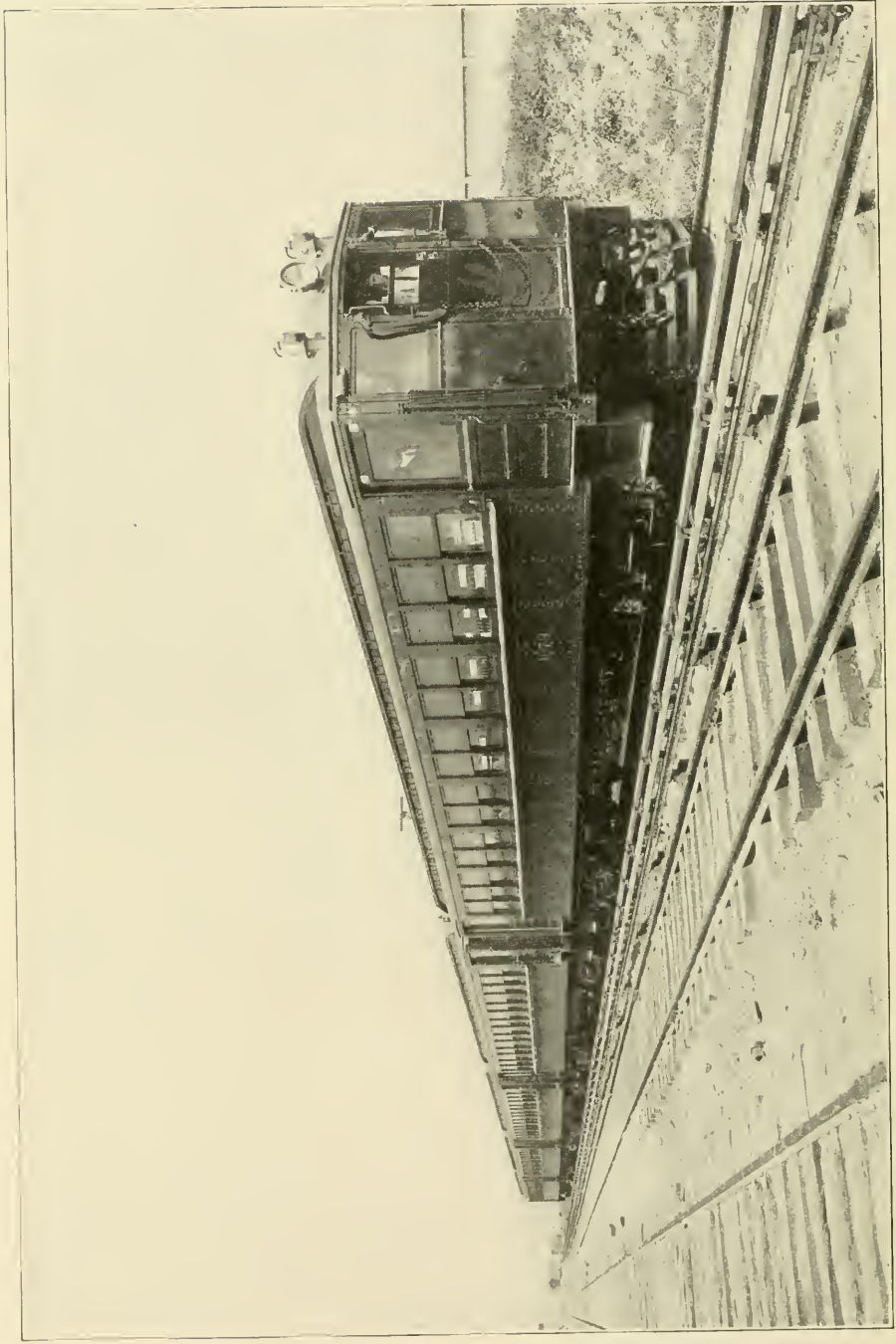

Fig. 77. Current Limit Relay Used by Denver Railway Company

handle to be rotated one notch at a time only. In order to disengage the pawl, the handle must be moved slightly backward on each notch. This operation delays the movement of the controller drum sufficiently to prevent the motorman from drawing an excessive amount of current each time the car starts, thus saving the replacement of fuses, and wear and tear on the equipment, and power plant.

Current Limit Relay. A simple electrical device is illustrated



MULTIPLE-UNIT CONTROL ELECTRIC TRAIN ON LONG ISLAND RAILROAD, EQUIPPED WITH WESTINGHOUSE MOTORS AND CONTROL APPARATUS

Courtesy of Westinghouse Electric and Manufacturing Company

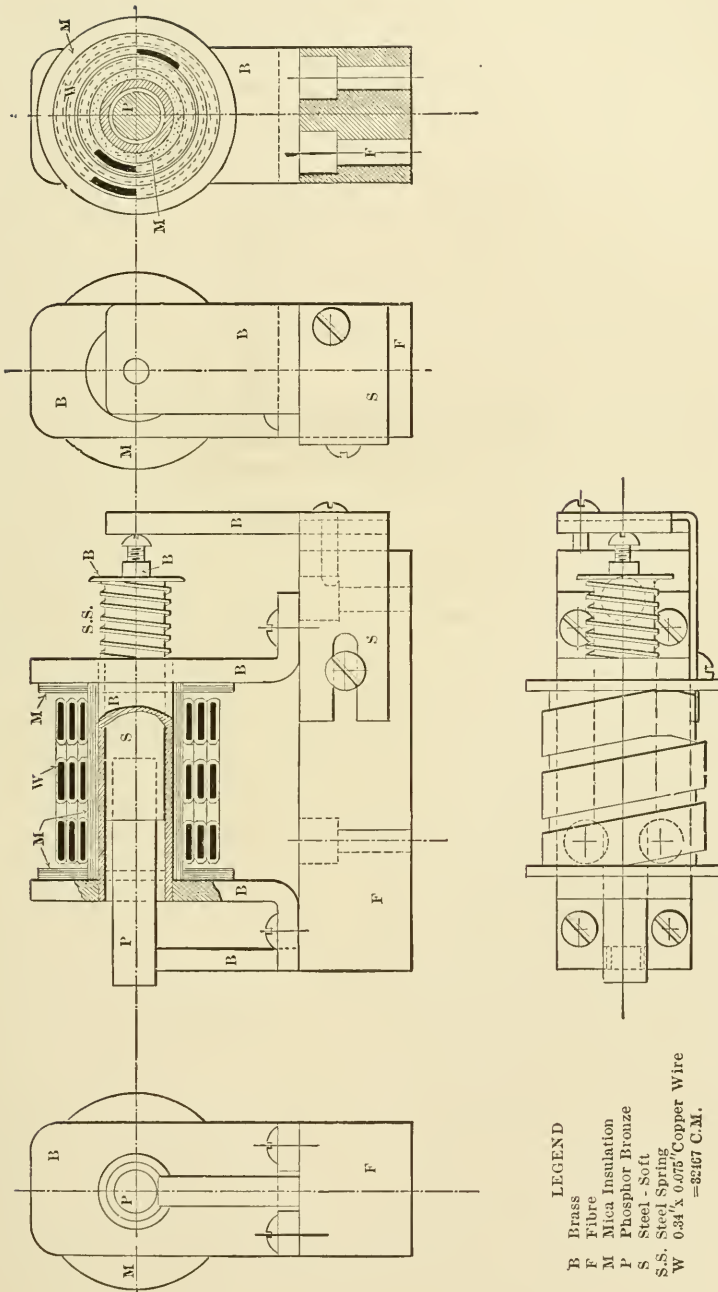

Fig. 78. Plan, Elevation and Section of Current Limit Relay

in Figs. 77 and 78. This is a coil and plunger mounted in the controller case. When excessive current is drawn the plunger is attracted into the coil and pushes a bronze plug under the star-wheel of the controller, where it engages a pin which stops the movement of the controller handle. When the current falls below a predetermined value the plunger is automatically withdrawn, thus allowing further movement of the handle until another excessive demand is made upon the circuit.

CONTROL APPARATUS ON GENERAL ELECTRIC 1200-VOLT EQUIPMENT

Whereas the standard voltage in use on trolley systems has for several years been 600 volts, there has been a strong tendency lately to increase this voltage on interurban railway systems to 1,200 volts. This necessitates either the use of two 1,200-volt motors or the use of two pairs of 600-volt motors, the motors of each pair being in series for operation on 1,200 volts. As the low-voltage motors are standard and are more cheaply maintained than the others (on account of the smaller electrical strain upon the insulation), they have been largely used in the high-voltage lines.

There is an additional advantage in the use of the low-voltage motors in that, if it is desired to operate them on systems using 600 volts, they can be run at the same speed as on 1,200-volt lines by simply connecting all four motors in parallel.

In high-voltage equipments the lamps, control circuits, and in some cases the air compressors, are supplied with 600-volt current. This permits the use of standard apparatus. These circuits are connected between trolley and ground through a machine known as a *dynamotor*, which, as its name implies, is both a generator and a motor. It is a small direct-current, compound-wound motor with two windings on the armature, and two commutators, one on each end of the shaft.

The two armature windings which are shown diagrammatically as A' and A'' in Fig. 79 are connected in series across the line. Current at one-half line voltage is taken off between the left-hand terminal and the center (the point marked 15) of the series field F'' , and then sent through the control circuits, etc. If the equipment were designed to operate on high-line voltage con-

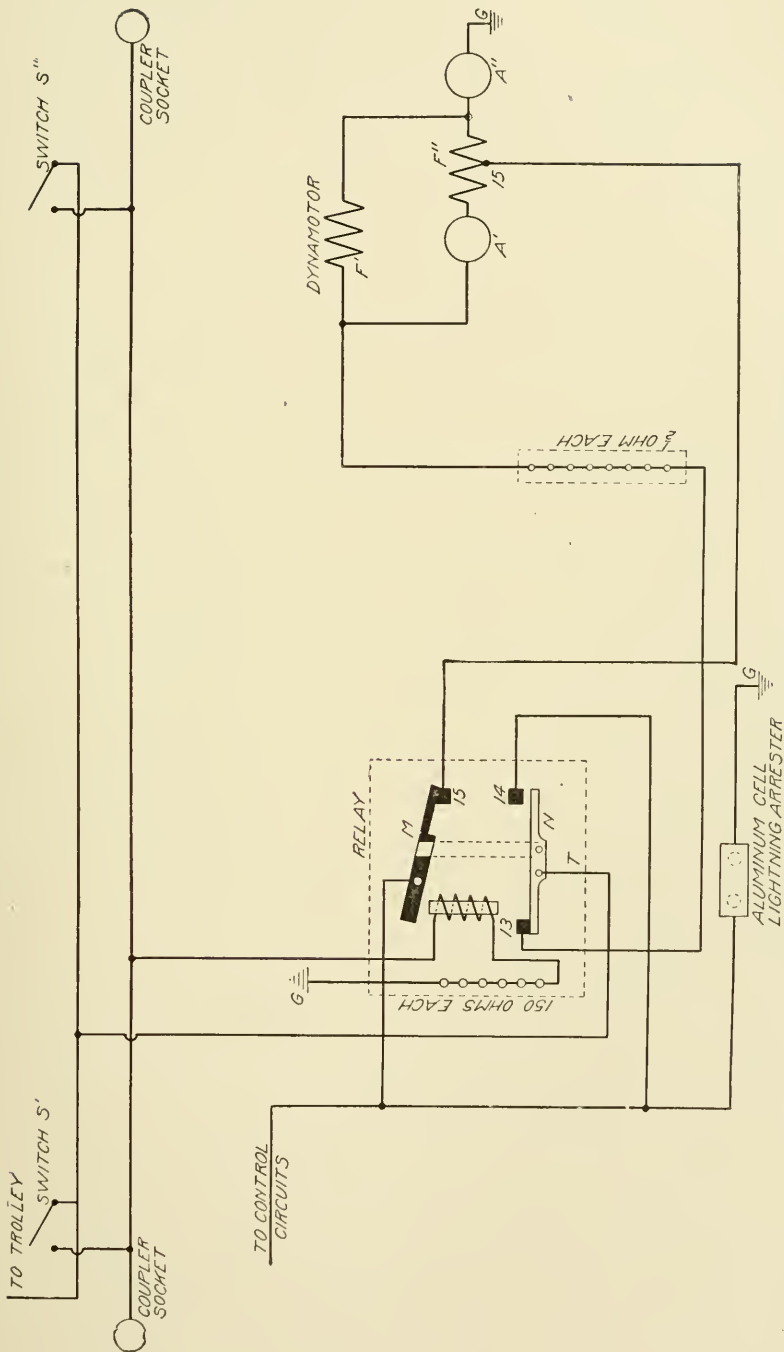

Fig. 79. Diagram of Control Apparatus of General Electric 1200-Volt Car Equipment

tinuously, no additional equipment in the control circuit would be required. This apparatus, however, is designed to operate on either 1,200- or 600-volt circuits, and as the dynamotor is not necessary at the lower voltage, some device must be used to cut it out of the circuit when it is not needed and to connect the control circuits direct to the trolley. This adjustment is accomplished by the aid of a special form of relay and a switch.

The relay is shown diagrammatically in Fig. 79. It consists of a coil and core with a pivoted iron armature M above. When the coil is energized the core attracts the armature. The armature carries a switch arm which makes and breaks contact at 15 . Below the coil is a second pivoted switch arm N , which makes and breaks contact at 13 and 14 . The lower arm is connected with the upper by the link represented by the dash line. The positions of the moving parts of the relay, as shown in the diagram, are for 1,200-volt operation the solenoid circuit being open. In this position the trolley current enters at the pivot of the switch N , passing out at 13 . Thence it flows through the resistance to the dynamotor. The latter has a shunt field F' and a series field F'' and two armatures A' and A'' , all connected as shown. The dynamotor then operates as a compound-wound motor.

The current for the control circuits, and any others requiring 600 volts, is taken off from the middle of field winding and flows through contact 15 and switch arm M , and through the control circuits to ground.

When it is desired to operate the control circuits directly on the line, *i. e.*, when the line voltage is 600 volts, switch S' or S'' is closed and the relay solenoid is energized. This results in the armature M being attracted and, as switch N is connected to it, both switch arms are simultaneously operated. Contacts 15 and 13 are thus opened, cutting the dynamotor entirely out of circuit. Current now flows from the trolley through the pivot of switch-arm N , through contact 14 , direct to the control circuits.

The connection of wire 15 at the middle of the series field winding is an important feature of the success of this scheme. When the dynamotor starts up, the current in the series winding is effective in producing a powerful torque as it strengthens the field. When current is drawn from the middle of the series winding to supply

the control circuits, it flows partly through armature A' and partly through A'' . These two components of the current flow in opposite directions in the series winding and thus neutralize each other. The series winding has, therefore, no effect on the operation of the machine when it is running as a generator, but is effective only when it is a motor.

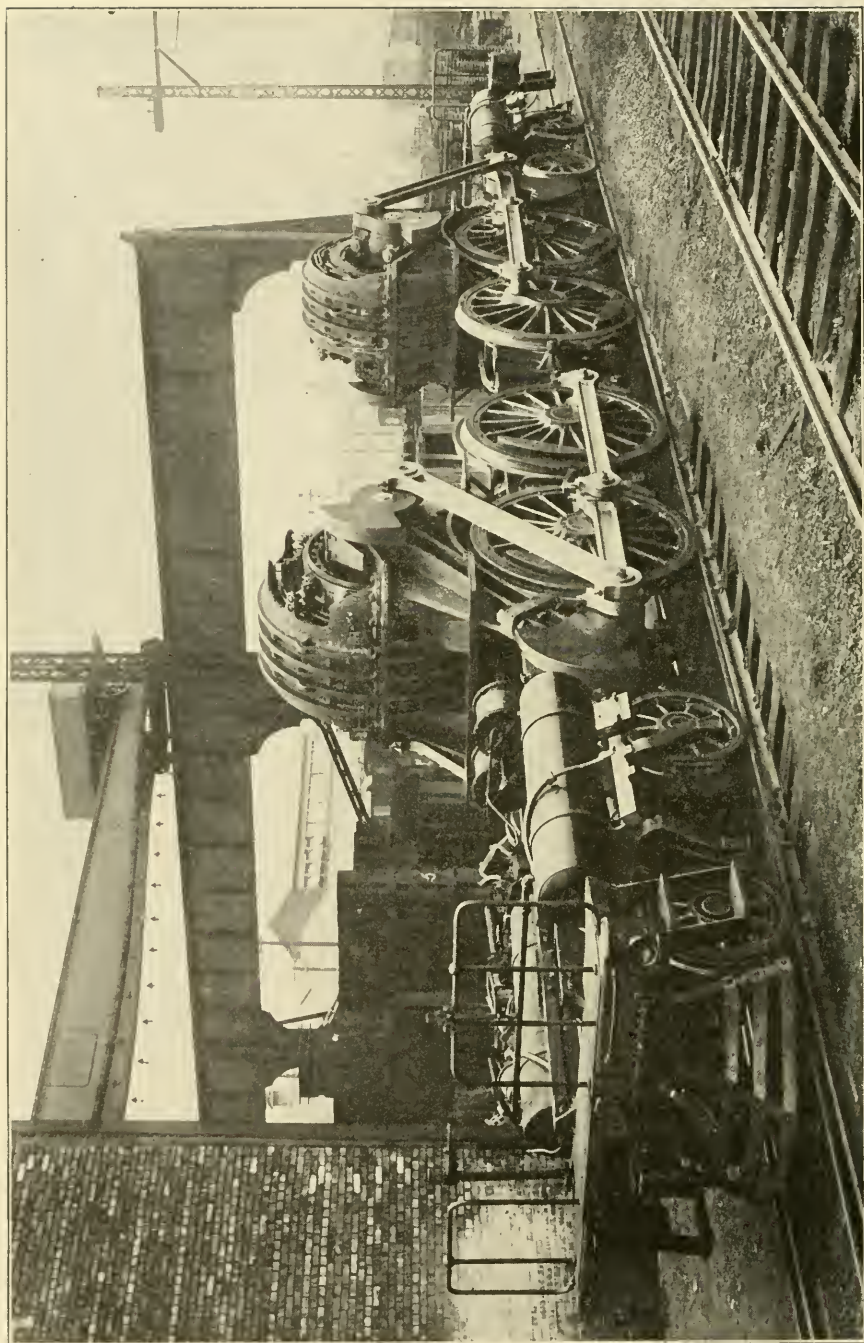

MOTORS AND RUNNING GEAR OF PENNSYLVANIA RAILROAD LOCOMOTIVE USED IN HAULING TRAIN TO AND FROM PENNSYLVANIA TERMINAL, NEW YORK CITY

Motors have rating of 2000-horsepower each. Note side rod construction similar to steam locomotive
Courtesy of Westinghouse Electric and Manufacturing Company

ELECTRIC RAILWAYS

PART II

BRAKES AND BRAKING

The standard device for bringing cars to rest is the brake-shoe already illustrated under the subject of truck details. The brake-head and shoe is carried by a link or hanger as shown in Fig. 80, which supports the weight but leaves the head free to move in the direction of the wheel radius. The head and shoe are pushed or pulled by a system of levers, rods, and chains, thus, by means of friction, producing a retarding force on the wheel rim. The brake-heads may be hung either between the wheels ("inside hung") or outside the wheels ("outside hung").

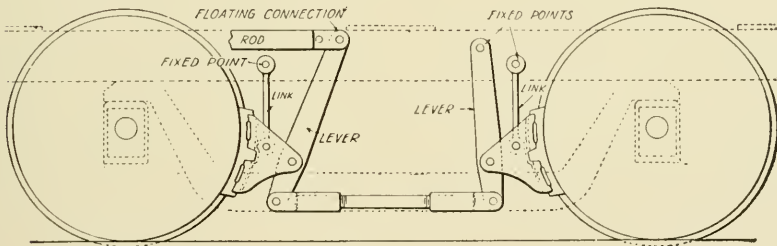

Fig. 80. Brake Mechanism, Showing Brake-Head, Shoes, and Hanger

A simple brake rigging for a single-truck car is shown diagrammatically in Fig. 81. The four brake-heads are shown, but the hangers are cut off for clearness. The two brake-heads for each pair of wheels are connected by a cross-bar B or B' , which holds them in proper alignment. The shoes are held away from the wheels by the springs marked P . The cross-bars BB' are connected by two tension rods KK which have double flat straps SS' at their ends. The cross-bars slide in these straps until they come up against the bolts which form stops at the ends. The tension rods are connected near the ends by cross-bars EE' .

In order to apply pressure to the brake-shoes, a lever L or L' is hinged to cross-bar B or B' at a point slightly off its center. To the other end of the lever is attached a rod R which terminates in a chain wound around the brake-staff or spindle. This the motorman rotates by means of the brake-handle, winding or unwinding the chain, applying or releasing the brakes. From the point D on the lever L , a link connects the lever with the cross-bar E at C . The link slides upon cross-bar B and is not attached to it. The operation of applying the brakes is as follows: Tension applied to the rod R is transmitted at the point D to the link and to cross-bar E . At the same time a reaction occurs against cross-bar B at the fulcrum, or hinge, of the lever. The result is that bar B , with the brake-shoes, is pressed to the right, and bar C , with the tension rods KK , is pulled to the left. The straps upon the right-hand ends of rods KK

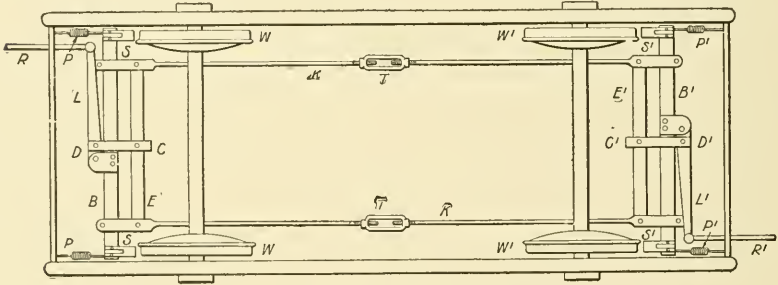

Fig. 81. Brake Rigging for Single-Truck Car

slide upon right-hand cross-bar B' until the stops strike the bar after which it is pulled, with its brake-shoes, to the left. As a result, the four brake-shoes are applied with nearly the same pressure by means of the tension in the rod R . The pressure cannot be exactly equal because the tension in the rod R tends to pull the whole brake-rigging to the left. The pressure on the right-hand shoes is, therefore, greater than that on the left by the amount of the tension in rod R . The difference between these two pressures is not sufficient, however, to make it necessary to provide an adjustment for correcting it. The brake-pressure may be applied by the motorman by means of the brake-staff at either end of the car as both ends are exactly alike.

PRACTICE PROBLEM

If lever L is 4 feet long between fulcrum and point of attachment of rod R , and if point D is 6 inches from the fulcrum, calculate all brake-shoe pressures when the tension in rod R is 500 pounds. (Neglect the effect of springs PP' .)

Solution: Consider first that the left-hand brake-shoes are against the wheels so that the fulcrum is fixed. Then the tension at point C is

$$F_R = 500 \times \frac{4 \times 12}{6} = 4000 \text{ pounds}$$

This force is transmitted through KK to the right-hand shoes, each of which receives 2,000 pounds.

Again consider that the right-hand shoes are against the wheels. Then the reaction against left-hand cross-bar B is

$$F_L = 500 \times \frac{(4 \times 12) - 6}{6} = 3500 \text{ pounds}$$

This force is transmitted to the left-hand brake-shoes each of which receives 1,750 pounds.

In Fig. 81, turnbuckles TT are shown in tension rods KK . These are to permit adjustment of the brake-shoe positions. Just enough clearance between shoes and wheel rims is allowed to permit them to clear each other. As the shoes wear rapidly, frequent adjustment is necessary.

The brake-staff is an iron rod located near the extreme end of the car in a convenient position for right-hand operation by the motorman. It is provided with a brass ratchet handle at the top. Just above the platform floor, the staff carries a ratchet wheel in the teeth of which a pawl, hinged on the floor, can be engaged by motion of the motorman's foot. This permits the brake to be locked in position and relieves the motorman's arm.

Peacock Brake. Fig. 82 shows a simple device for improving the operation of the ordinary spindle brake-staff. The

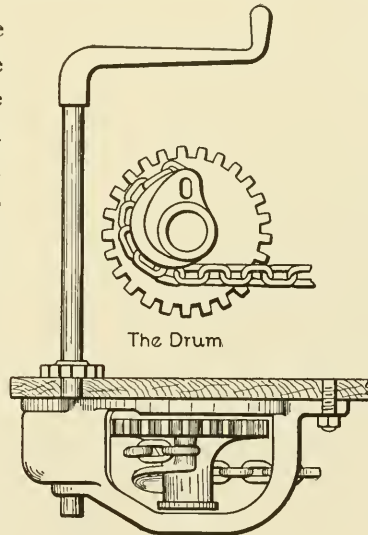

Fig. 82. Peacock Brake

lower end of the staff carries a pinion which meshes with a larger gear wheel. The latter rotates a spiral drum, the radius of which increases upward from the bottom. The chain is attached at the top where the radius of the drum is greatest. In operation the chain winds up rapidly at first while the slack is being taken up. As it is wound up the tension in it increases as it reaches the smaller part of the drum. The tension is thus varied during the brake application and the shoe pressure can be graduated to suit the requirements.

Brake Rigging on Double-Truck Cars. The arrangement of the brake-levers and tension-rods in a double-truck car is shown in Fig. 83. As previously explained each brake-head is suspended by a link or is supported in any other way which will give it freedom of movement in the direction of the radius of the wheel. These links are not represented in the diagram. Each head is attached to a lever through which the pressure is applied. Beginning in the lower right-hand corner of the diagram we note that the upper end of the left-hand lever is attached to a fixed point on the truck. Ten inches below the point of attachment the head is pivoted. Four inches below this is a rod which connects the lower ends of the two levers on one side of the truck. The right-hand lever is a floating lever, its only point of support being at the brake-head, which is hung by a link. When tension is applied to the upper end of the right-hand lever, its shoe is pressed against the wheel. The reaction at the bottom of the lever is transmitted to the lower end of the left-hand lever and its shoe is pressed against its wheel. Thus one tension applies both shoes. In order that both shoes may exert practically the same pressure on the wheel rims, the lever arms of the two levers are of different lengths.

For a tension of 1,000 pounds in the tension rod in Fig. 83 there is applied to the first brake-shoe a force

$$F_1 = 1000 \times \frac{14+4}{4} = 4500 \text{ pounds}$$

The reaction at the lower end of the lever is

$$F_2 = 1000 \times \frac{14}{4} = 3500 \text{ pounds}$$

This force F_2 is transmitted to the left-hand lever and produces at

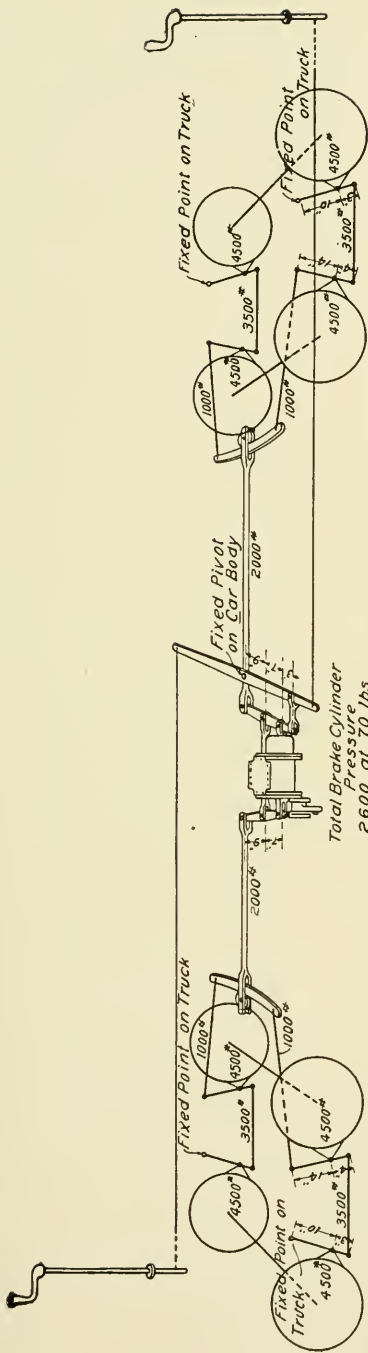

Fig. 83. Diagram of Brake-Levers and Tension Rods in a Double-Truck Car

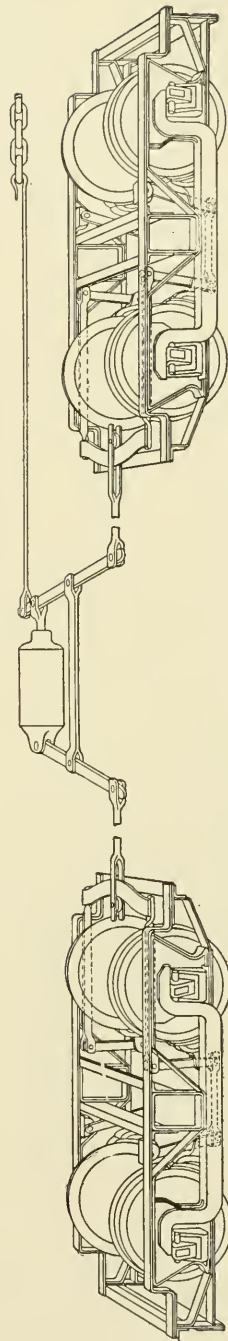

Fig. 84. Brake-Levers and Air-Brake Attachment for Double-Truck Car

the brake-shoe a force

$$F_3 = 3500 \times \frac{10+3}{10} = 4550 \text{ pounds}$$

The diagram represents an air power brake, and the hand-brake apparatus, which operates independently of the power brake, is also shown. The power-brake apparatus could be omitted with slight modification of the lever system and many double-truck cars are so equipped. The tendency, however, is toward air brakes for double-truck cars as these are usually too heavy to be stopped effectively with the hand brakes.

In Fig. 84 is shown a system of brake-levers, etc., for a double-truck car. It does not differ essentially from the previous diagram except that it shows a case in which only one hand brake is used. This indicates that the car has been equipped with control apparatus on one end only, as is sometimes done. Such cars always operate in one direction only and are turned by means of a loop in the track at the end of the line or by means of a switch. This diagram is instructive in that the trucks are shown with the bolsters removed, leaving the transoms conspicuously placed. It is possible to remove the bolsters, elliptical springs, and spring planks by detaching the links by which the spring planks are supported.

It is impracticable to stop very heavy cars by hand as the required tension in the brake-rod and chain is too great to be produced by hand. For safety of the passengers, economy of operation, and relief of the motorman from excessive strain on the arm, power brakes are a necessity on heavy cars. There is no definite weight above which brakes are necessary, as this is a matter of speed as well as of weight. The principal form of power brake is the air brake which is readily adaptable to electric traction conditions.

AIR BRAKES

Air brakes are in use in two forms, *straight* and *automatic*. The former employs the air direct from a reservoir, through a control valve, to the brake cylinder. The latter applies the air from an auxiliary reservoir, through an auxiliary valve, which is operated by air-pressure in a train line. The auxiliary valve admits air to the brake cylinders when the train-line pressure is *reduced*. The

brakes are thus set automatically if the train line is accidentally broken. As the straight air equipment is in most common use and as it is the simpler of the two, it will be described first.

Straight Air Brake. The Westinghouse straight air-brake system is composed of the following principal parts:

(1) An *air compressor*, operated by an electric motor, to provide compressed air.

(2) A *governor* which automatically controls the action of the compressor, thereby maintaining the supply of compressed air at the proper pressure.

(3) A *system of wiring*, with the proper switches, fuse-boxes, etc., which connect the trolley current to the governor and compressor.

(4) A *large reservoir* in which compressed air is stored.

(5) A *brake cylinder and piston*, the piston-rod of which is connected to the brake-rods in such a manner that when compressed air is admitted to the cylinder, and the piston moves outward, the brake-shoes are pressed against the tread of the wheels.

(6) An *operating valve* placed at either end of the car, by means of which compressed air can be admitted from the reservoir into the brake cylinder and exhausted from the brake cylinder to the atmosphere.

(7) A *system of piping* connecting the above-mentioned parts, and, when trailers are used, including flexible hose and couplings and cut-out cocks.

(8) A *safety-valve* connected to the reservoir to prevent too great an accumulation of air should the governor fail to operate.

(9) A *chime whistle* connected to the air-supply, to be used as a warning of approach.

The general arrangement, names, and relative location of all parts, are shown diagrammatically in Fig. 85.

Operating Straight Air Brake. The operating valve has notches placed upon it which mark the position of the handle for the various positions of the valve. This fact enables one to operate the brake with certainty the first time, but smooth and accurate stops can be made only after a little practice. Beginning from the right and going to the left, the different positions of the valve handle are as follows: *Emergency position, service position, lap position, and*

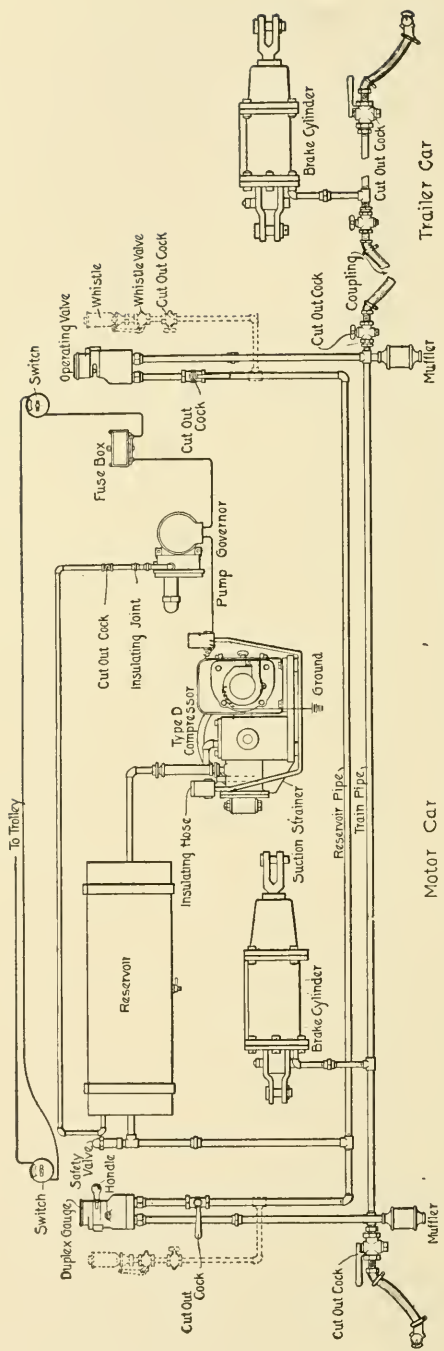

MOTOR CAR
 Trailer Car
 Fig. 85. Diagram of Air-Brake Connections for Motor Car

release position, Fig. 95. When the handle is in the lap position, as indicated by the deep notch, the main ports in the valve are closed, and compressed air cannot enter the brake cylinder from the reservoir, and any compressed air which may be in the brake cylinder cannot exhaust into the atmosphere. If the handle is now moved from this position to the extreme left, it will then occupy the release position. In this position, any air which may have been in the brake cylinder will be exhausted into the atmosphere, and the brake will be released. This is the position the handle should occupy while running on a level track. If the handle is moved from the release position to the service position, air will flow very slowly from the reservoir into the brake cylinder, and service application results. If, however, the handle is moved from the release position to the extreme right—the emergency position—a large amount of air rushes from the reservoir into the brake cylinder, and an emergency application is obtained. If the car is coasting down a grade, and the handle is moved to the service position for an instant and immediately returned to lap position, a small amount of air is admitted to the brake cylinder and retained, thus holding the brakes applied. With a little experience, the proper amount of air can be admitted to the brake cylinder in order that a constant speed may be maintained. If too much air is admitted into the brake cylinder, a small portion can be exhausted by throwing the handle to release position for an instant, then back to lap position.

The quickest stop possible is made by throwing the handle at once to the emergency position, giving to the wheels the greatest possible braking pressure. The higher the speed, the greater the pressure that can be applied without danger of sliding the wheels. Thus it is seen that the quickest stop can be made by applying at once full braking pressure—depending on the speed—and gradually releasing as the speed decreases. This method insures a smooth stop, as the rapid reduction of speed at the end of the stop, which throws passengers forward, is avoided. In making a service stop, about twenty-five or thirty pounds of air pressure should be quickly admitted to the brake cylinder, and gradually reduced as the speed decreases, retaining about ten pounds in the cylinder until the car stops. A little experience is necessary in order to know just what pressures to use to be able to stop in a given distance. A succession

of applications and release in stopping a car imparts a very disagreeable motion to the car, and is very wasteful of compressed air. In making emergency applications, the handle is thrown to the emergency position, and brake-cylinder pressure of, say 60 pounds is obtained almost instantly. Sand should then be applied, and the handle brought at once to the lap position. The brake cylinder pressure should then be released little by little as the speed drops.

When the signal is received to go ahead, the handle should be placed in release position before turning on the power. When descending a grade, the inexperienced man usually makes the mistake of applying the brake too hard at the start. It should be borne in mind that the car will not at once take the speed desired, and that some time is required for conditions to become constant. An easy application should first be made, and the handle held on *lap* until the car has sufficient time to feel the effect of the brake. If the speed of the car is still too high, let in a little more air, and repeat the operation as often as is necessary until off the grade.

The following instructions are given by the Westinghouse Company to motormen:

When leaving the car, always set up the hand brake, as some one might tamper with the cut-out cocks.

Before starting from the car-barn, be sure all cocks are properly set, and that there is a good supply of air in the reservoir.

Insert the handle in its socket in the operating valve, and throw it around to emergency, then back to release, to see that it works freely.

Try the air brake both in *service* and in *emergency*, to make sure that it has not been left improperly connected, etc. After this trial, and as long as proper pressure is maintained, the brake may be relied upon to perform its duty.

Air Compressor. The air compressor may be either axle-driven or motor-driven. Since there are some objections raised against using the axle-driven compressor, and since the motor-driven compressor is more commonly used, it is deemed advisable to confine ourselves to the motor-driven compressor. Reference will be made to Figs. 86, 87, and 88. All metal parts, such as pistons, rods, frames, etc., will be referred to as *1, 2, 3*, etc., while all cavities and chambers will be called *A, B, C*, etc.

The motor is of the series type, having an opening at the commutator end which permits of ready access to the commutator. This

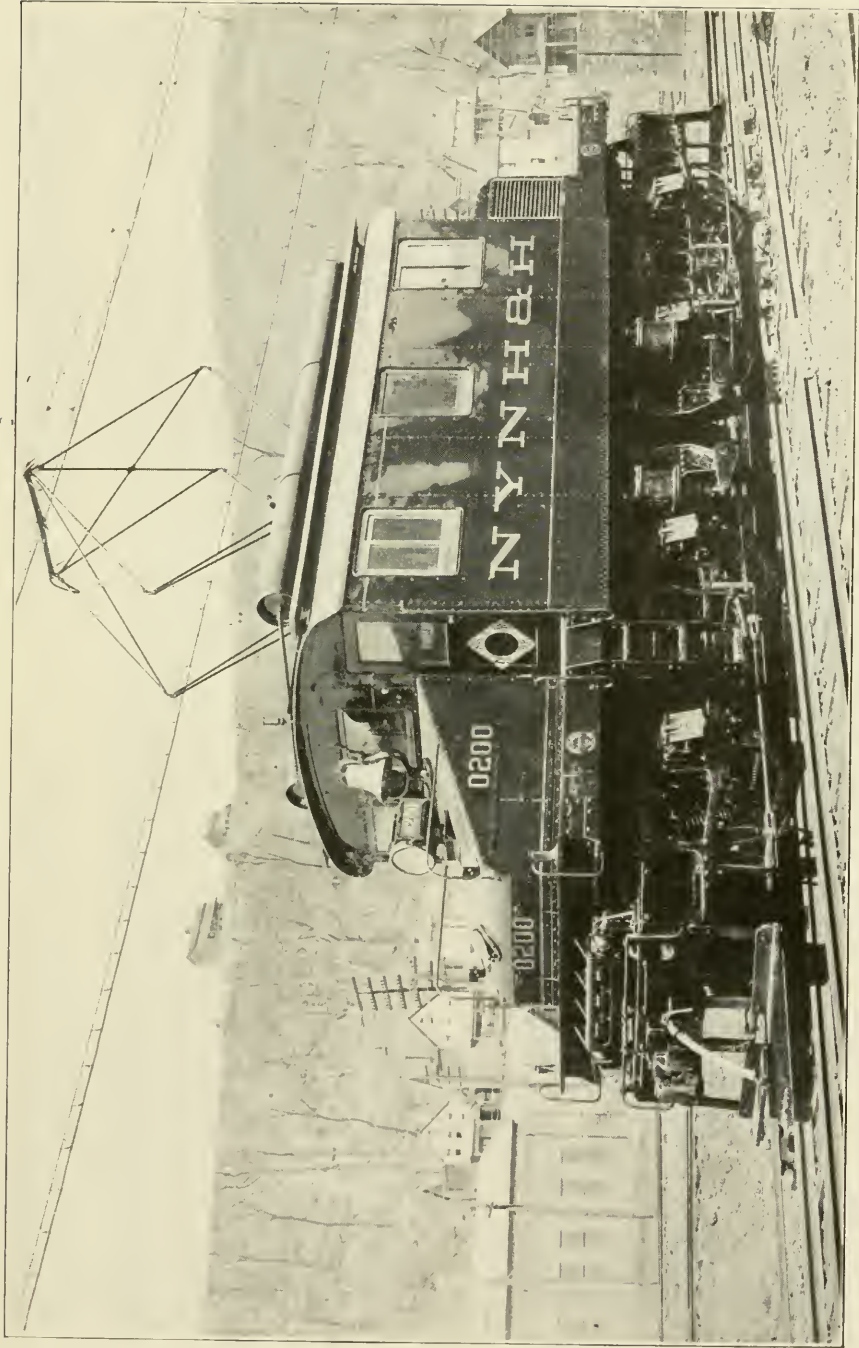

STANDARD ELECTRIC SWITCHING LOCOMOTIVE USED ON NEW YORK, NEW HAVEN, AND HARTFORD ROAD
Courtesy of Westinghouse Electric and Manufacturing Company

opening is provided with a tight-fitting door which excludes all dirt, dust, and moisture. In the ends of the frame are fitted heads 1 and 2, which provide bearings for the ends of the armature. Each

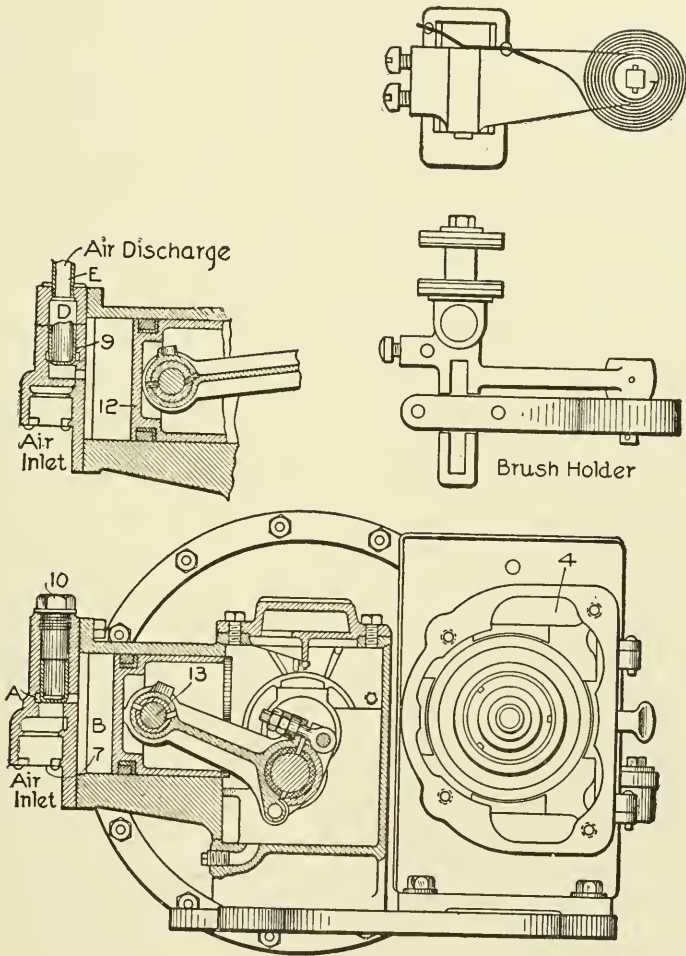

Fig. 86. Diagram of Parts of Motor Driven from Pressure

bearing is provided with two oil-rings which secure proper lubrication of the shaft. Oil holes are provided for filling the oil wells, and the location is such that there is no danger of flooding the interior of the motor with oil. A passageway at the pinion end conducts any excess

of gear-lubricating oil to the bottom of the gear case, thus assisting in preventing any flooding of the motor. Two of the poles of the motor are a part of the frame 3, and two are made up of soft laminated iron 4 bolted to the frame. The armature 5 is made up of soft-steel punchings which have accurately spaced slots in which are imbedded coils of uniform size. The brush-holders 6 are made of brass and

are bolted to a cast-iron yoke with proper insulation. The brushes are carbon, and are held against the armature by coiled springs.

The action of the compressor in compressing air is as follows: Air is drawn through the suction screen 7, lifts the check-valves 8, and passes through the ports *A* into the cylinders *B*. On the return stroke, the compressed air is forced out through the ports *C*, lifting the discharge valves 9, then passing into the chamber *D*, and finally into the discharge pipe *E*. The suction and discharge valves are made of steel, and are accessible by removing the caps 10 and 11, respectively. These valves do not have any coiled springs to seat them, but close by gravity.

The pistons 12 are accurately fitted with rings, and are made long so as to reduce the amount of wear. When repairing the pump, the rings should always be

kept with the piston to which they belong. The wrist pin 13 is made of steel, and works on a bronze bushing in the connecting rod. The crank end of the connecting rod is lined with bab-bitt which works on the crank, and has suitable means for adjustment. The center line of the cylinders is placed above that of the crank shaft, in order that the angularity of the connecting rod

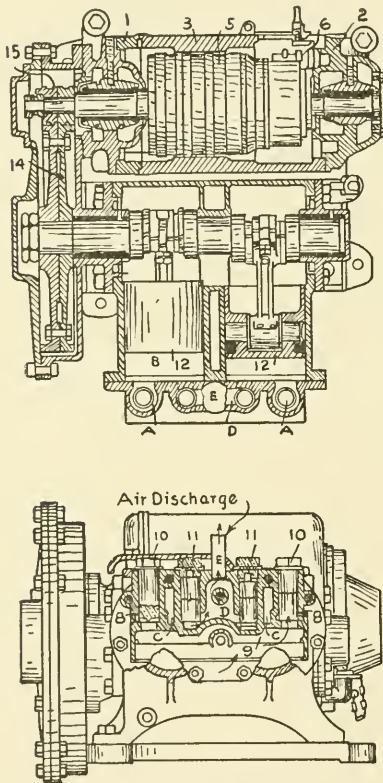

Fig. 87. Section of Motor and Pump in Motor Driven from Pressure

may be reduced during the compression stroke. This reduces the vertical component of the thrust on the pistons, and thereby reduces the amount of wear on the cylinders. It should be remembered, however, that the pump should always run with the compression part of the stroke on the upper half of the revolution. The crank-shaft is made of forged steel, and has two bronze bearings, one at either end, and a babbitt bearing in the middle. The crank-shaft bearings, wrist-pins, and crank-pins are lubricated by the splash system, from a bath of oil in the crank case. The gear wheels 14 and 15 are of the *herringbone* type, and are lubricated from a bath of oil in the dust-proof gear case.

An air compressor heats very rapidly when in operation, if no means are provided to conduct the heat away. For this reason, com-

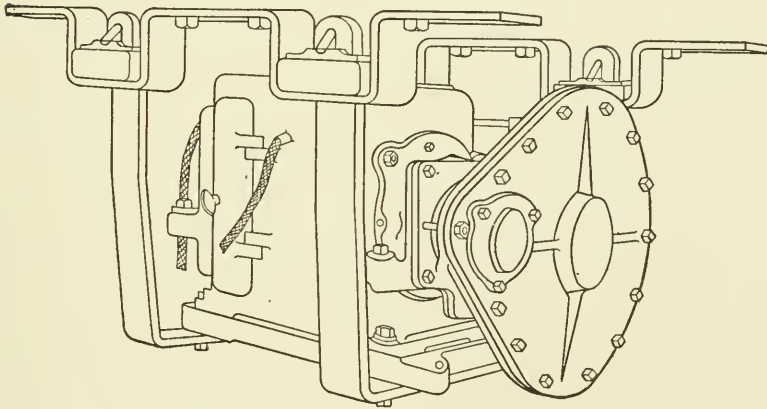

Fig. 88. Westinghouse Air Compressor Complete

pressors which are designed for continuous service are always water-jacketed. Since compressors for electric-car service are used intermittently, they have time to cool, and a water-jacket is unnecessary. Experience has shown that such a compressor as just described, when compressing air at 100 pounds per square inch, should not run longer than 15 minutes at a time, and should then be permitted to cool at least fifteen minutes. This compressor is suspended under the car, in the position shown in Fig. 88, when in service. The method of suspension permits of its being readily removed for repairing.

Pump Governor. The location of the governor is shown in Fig. 85. Its purpose is to start and to stop the compressor in order to maintain a predetermined pressure, by alternately making and breaking the circuit leading to the motor. The governor is shown in front

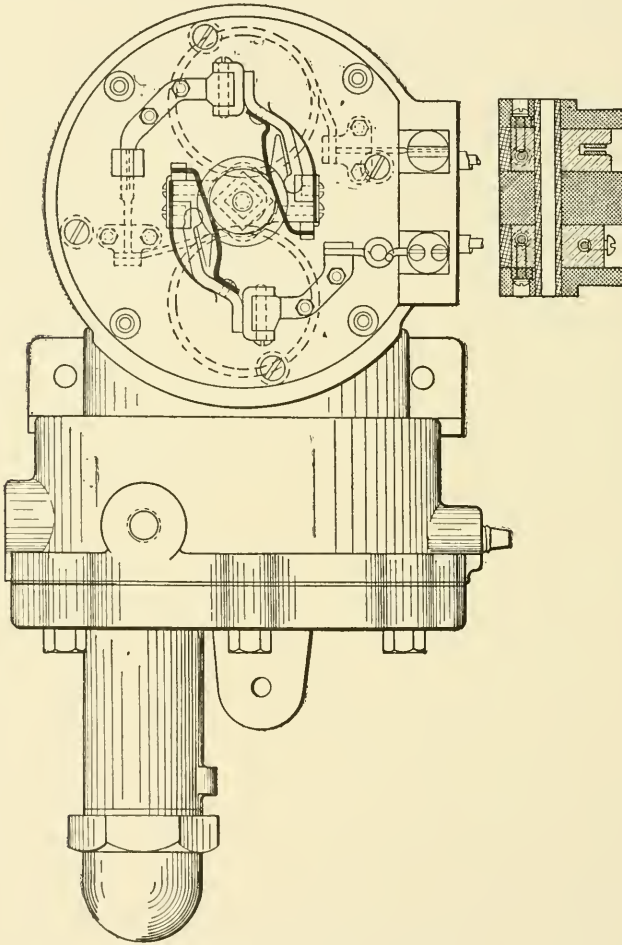

Fig. 89. Front View of Pump Governor

view in Fig. 89, and in section in Figs. 90 and 91. The chamber *A* is in communication with the reservoir. The other side of the diaphragm *1*, which forms one wall of the chamber *A*, is open to the atmosphere. The diaphragm *1*, therefore, is subjected to reser-

voir pressure on the one side and to atmospheric pressure and the regulating spring *2* on the other. The slide valve *3* is connected to

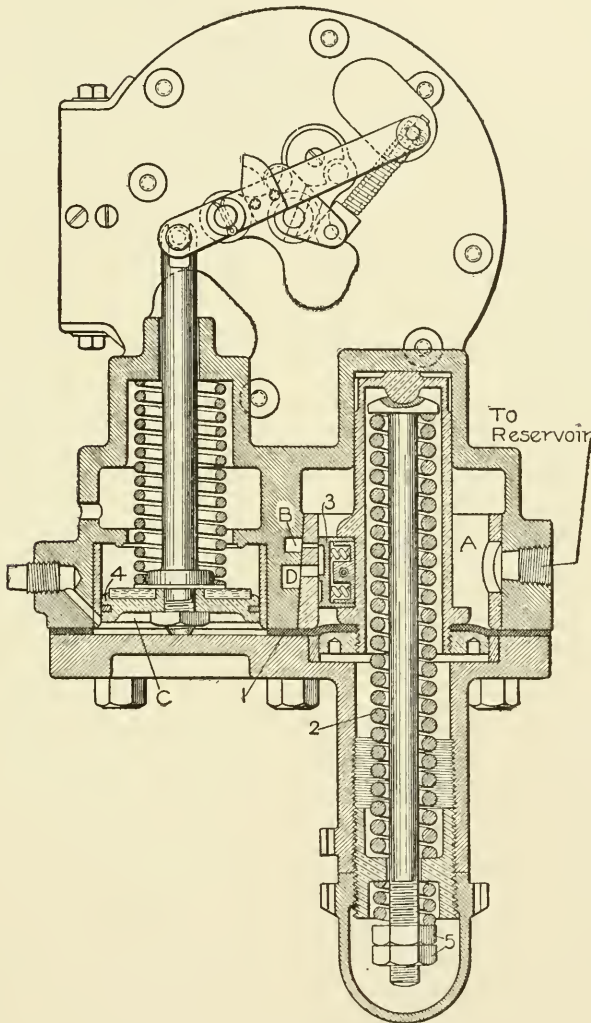

Fig. 90. Part Section of Pump Governor

the diaphragm *1* in such a manner that any movement of the latter operates the former. When the maximum pressure is attained, the regulating spring *2* is so adjusted that the diaphragm *1* is pressed

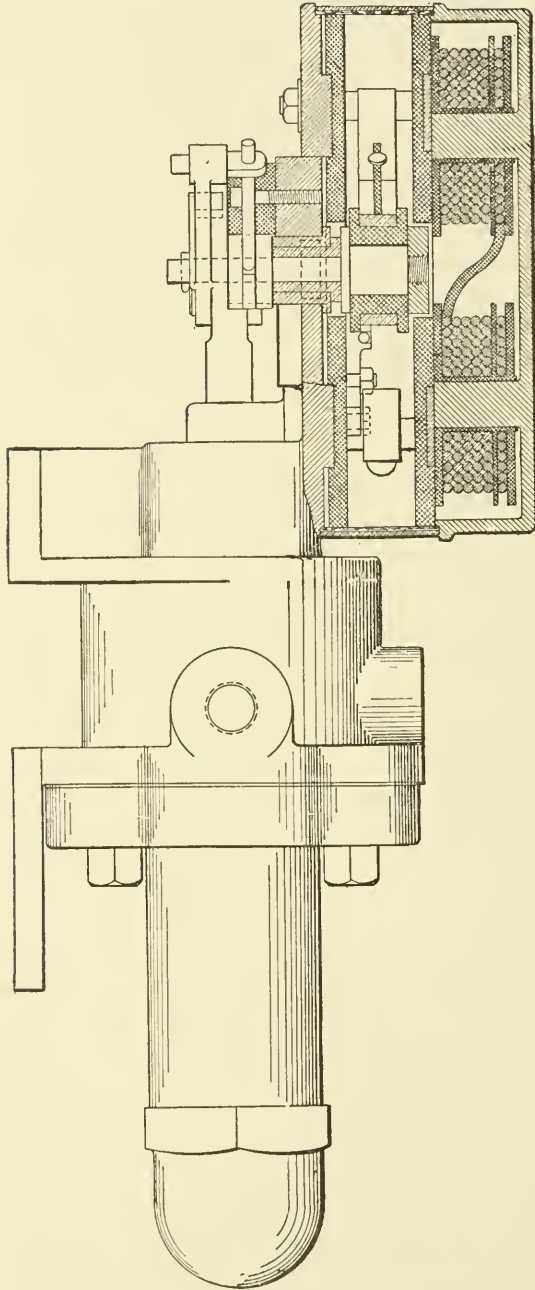

Fig. 91. Part Section of Pump Governor

downward. This moves the slide valve *3* and uncovers the port *B*, which is in communication with the chamber *C*. The air pressure now in the chamber *C* forces the piston *4* upward, thereby opening the switch in the motor circuit, and the motor stops. When the air pressure in the reservoir drops slightly, and consequently the pressure above the diaphragm *1* is reduced, the regulating spring *2* forces the diaphragm upward, which also moves the slide valve *3* and connects the port *B* with the exhaust port *D*. Air from the chamber *C* is now exhausted into the atmosphere; the piston *4* moves downward and closes the switch in the motor circuit; and the pump starts. This action continues, and maintains the required pressure in the reservoir. The mechanism on the upper part of the governor acts so as to cause the switch to open and close very rapidly, and thus avoids undue arcing. The pressure at which the governor cuts out the motor is

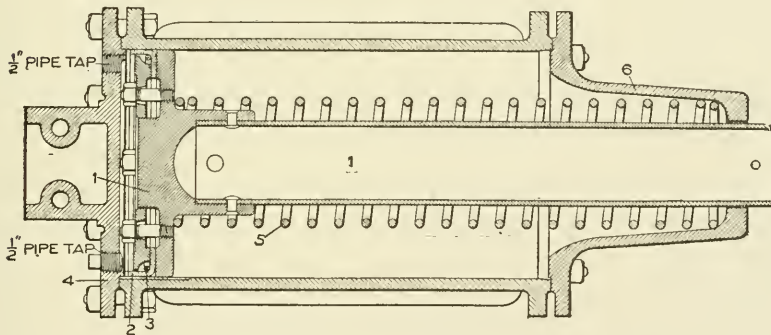

Fig. 92. Brake Cylinder of Hollow-Rod Type

controlled by adjusting the regulating spring *2* by means of the nuts *5*. The governor may be located either under the car or in one end of the car.

The electric apparatus above described is for direct current. Alternating-current motors and governors are being used to some extent, but have not yet come into very general use.

Reservoir. The reservoir should have a sufficient capacity to supply air for three or four applications without reducing the pressure more than 15 pounds. It is conveniently located under the car, and its dimensions depend upon the size of the brake cylinder used. It serves to collect moisture and oil, and prevents them from being

carried further into the system. It should be drained frequently, as its capacity for stored air will be reduced proportionally to the volume of water it contains.

Brake Cylinder. The brake cylinder shown in Fig. 92 is of the hollow-rod type. The piston is connected to the brake rigging in such

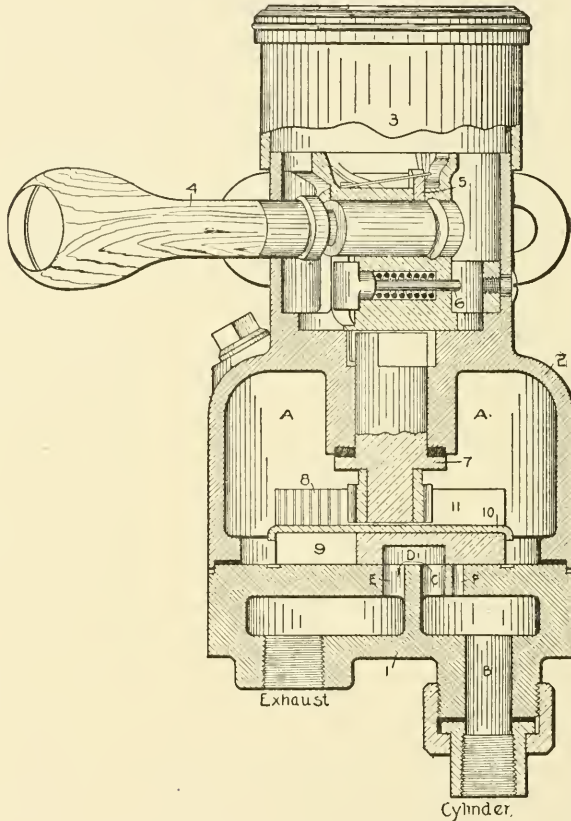

Fig. 93. Section of Air Operating Valve

a way that it moves only when the power brake is used. When the hand brake is used, no movement of the piston occurs. The piston rod *1* is made hollow to receive the push rod. A leather packing ring *2* is provided which prevents air from leaking around the piston. The leather packing ring is held against the walls of the cylinder by means of the round spring expander *3*. The cylinder head *4* may

be either plain or as shown. That shown is constructed to receive an automatic slack-adjuster which is sometimes used with the automatic system.

When an application is made, air enters behind the piston and forces it outward, compressing the release spring 5. When the air is exhausted from the cylinder, the release spring 5 pushes the piston back to its normal position. Cylinder head 6 is constructed so as to provide a place for the coil spring when the piston is forced outward. The size of the cylinder depends on the design of the brake rigging and on the weight of the car. The sizes commonly used are 8, 10, and 12 inches in diameter.

Operating Valve. The purpose and operation of the operating valve have already been described as well as the four positions of the valve.

In describing the mechanical details, reference will be made to Figs. 93, 94, and 95. The valve is cast in two parts—the base 1 and the head and body 2. On the top of the head is a double gauge 3; the red hand indicates the reservoir pressure; and the black hand, the brake-cylinder pressure. Just below the gauge is a socket into which fits the operating handle 4, which is removable. In swinging from the release position to the emergency position, the handle turns through about 130 degrees. The handle can be inserted and withdrawn only when the valve is in lap position. When the handle is withdrawn, the latch 5 is thrown into position by a small spring, and the valve is permanently locked until the handle is again inserted. Just below the handle socket is a second one which contains

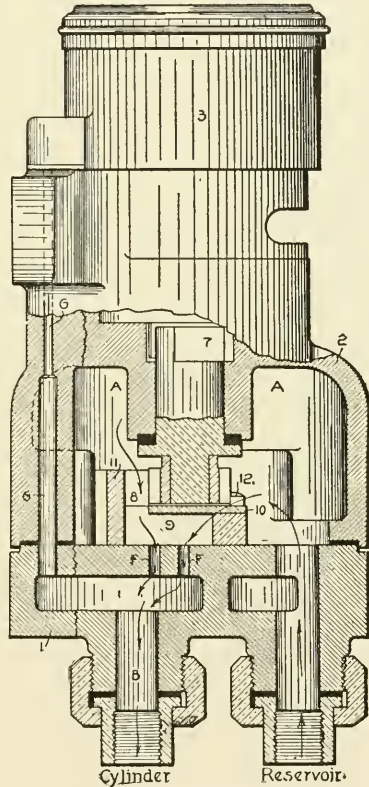

Fig. 94. Section of Air Operating Valve

a bolt *6* actuated by a spring. As the handle is turned, the head of the bolt *6* passes over notches which serve to indicate when the valve is in the proper position. Connected to the lower side of the socket is the stem *7*, having a pinion fitted to its lower end, which actuates the rack *8*. The rack *8* is connected to and operates the slide valve *9*. The spring plate *10* does not act as a stop for the slide valve *9*, but is used only to assist in getting the valve in the proper position when assembling the parts. The slide valve *9* moves between suitable guides *11* and *12*. The chamber *A* is always in communication with the reservoir, and a port leads to the gauge above, which indicates the pressure. In the figure, the valve is shown in release position; air passes from the cylinder through the

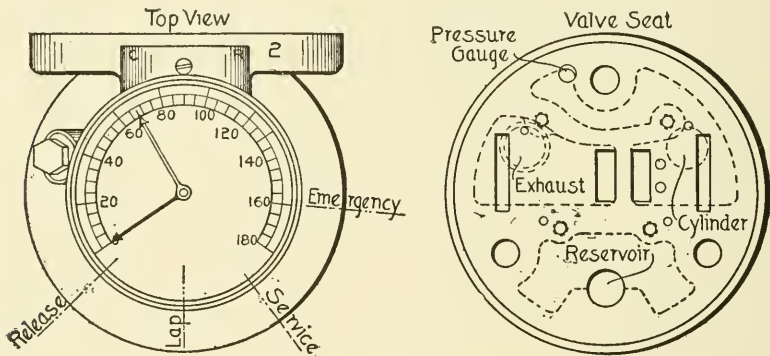

Fig. 95. Top View and Section of Valve Showing Pressure Gauge

pipe *B*, the port *C*, the cavity *D*, the port *E*, and thence to the exhaust pipe. When the valve is in emergency position, the right-hand edge of the slide valve *9* registers with the left-hand edge of the port *C*. Air then passes from the chamber *A*, through the ports *C* and *F*, through the pipe *B*, to the brake cylinder. In this position, the port *E* is blocked. In lap position, the right-hand portion of the slide valve *9* covers the ports *C* and *F*, and the port *E* is blocked. The port *G* connects the brake-cylinder pipe with the gauge above, which indicates the cylinder pressure.

Another form of this operating valve is sometimes used which has no gauge at the top to indicate the cylinder and reservoir pressures, but the operation is the same as in the case of the one just described.

The valve just described is sometimes used in a modified form, as shown in Fig. 96. Here the operating handle and valve parts are separate, the valve parts being bolted to the floor of the car. In operating this brake, the handle must be thrown in the opposite direction to that just described, but otherwise the operation of the valve is the same as previously given.

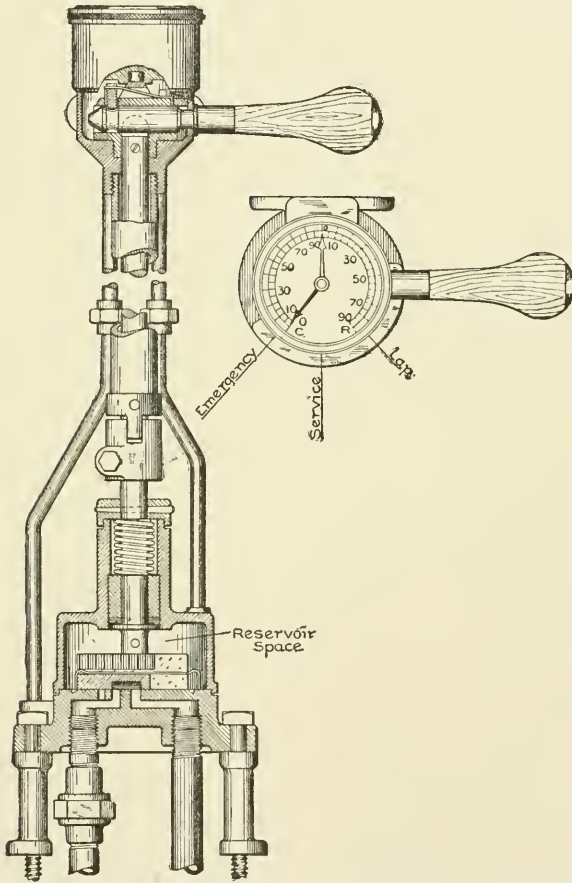

Fig. 96. Front View and Section of Another Form of Operating Valve

Piping. Referring to Fig. 85, the sizes of the various pipes are as follows:

The train pipe connecting the brake cylinder with the operating valve should be a standard $\frac{1}{2}$ -inch pipe. If more than one trailer is used, a $\frac{3}{4}$ -inch pipe should be used.

The reservoir pipe connecting the reservoir with the operating valve is a $\frac{1}{2}$ -inch pipe. A $\frac{3}{4}$ -inch pipe is better if it can be used conveniently.

The pump governor and whistle connections are made with $\frac{3}{8}$ -inch pipes. Wherever possible, long bends in pipes should be used, rather than a standard elbow fitting.

Safety Valve. The safety valve should be connected to the reservoir line leading to the controlling valve, at a point near the reservoir. Its operation may be understood by reference to Fig. 97. It can be set for any pressure by adjusting the regulating spring *1* by means of the nut *2*.

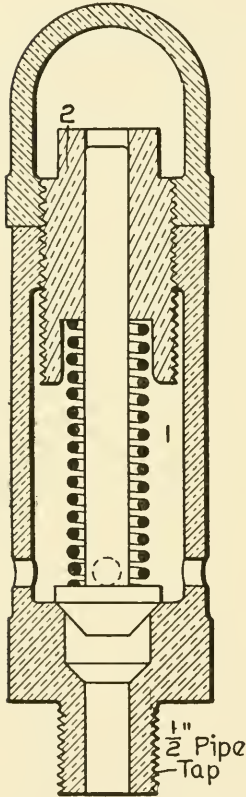

Fig. 97. Section of Safety Valve

In an axle-driven compressor equipment, a slight change in the piping is necessary from that above described. Since the compressor is mounted on the truck, and has some movement relative to the car frame which carries the reservoir, flexible hose connections are necessary in order to make connections to the reservoir and also to the compressor regulator. A small reservoir, which receives air from the compressor, is connected to the main reservoir by a pipe containing a regulating valve. The air attains a pressure of about 35 pounds in the small reservoir before any air passes into the main reservoir and this pressure, attained while the car runs about 100 yards, is available for applying the brakes. This always insures air for operating the brakes if the car previously runs a short distance. With this exception, the piping is the same, and no further description is necessary.

If a car is fitted with a storage air-brake equipment, no compressor is installed in the car. The compressed air which is used for braking is carried on the car in large reservoirs. The general scheme of a storage air-brake equipment is shown in Fig. 98. Two large reservoirs connected by a 1-inch pipe carry air at high pressure.

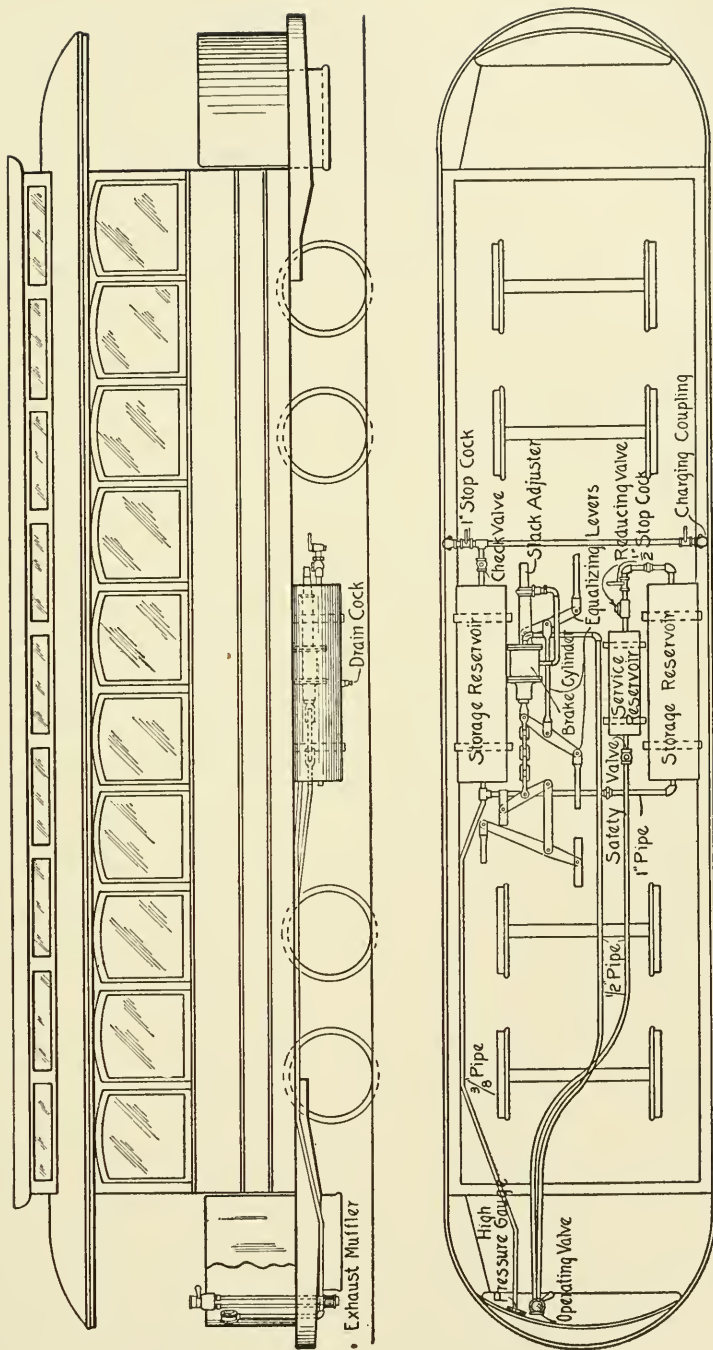

Fig. 98. Diagram of Storage Air-Brake Equipment

These reservoirs deliver air through a reducing valve to a service reservoir. The pressure in the service reservoir corresponds to that in the reservoir previously described. Other than these parts just mentioned, the straight air-brake and the storage air-brake systems are the same.

Westinghouse Automatic Friction Brake. The general scheme of the Westinghouse automatic friction brake equipment is shown in Fig. 99, which gives the names of the principal parts and their relative location. The principle of its operation is very different from that of the straight air-brake system in which the brake pipe is subjected to pressure only when an application is made. With the automatic system, air at 70 pounds of pressure per square inch is carried in the brake pipe. The brake is applied by exhausting air from the brake pipe, thus reducing its pressure; and it is released by restoring this pressure. It follows that any accident or operation which results in reducing the brake-pipe pressure will apply the brakes on all cars. This is not true, however, in case of the straight air-brake system. In the straight air-brake system, if any accident occurs to break or open the brake-pipe, the brake at once becomes inoperative. With the exception of compressed air being supplied by a motor-driven compressor, a governor controlling the operation of this compressor, and a change in the form of the brake valve, the system is almost identical with the Westinghouse system for steam-operated roads.

The standard automatic air-brake system as used on steam roads today cannot be successfully operated on electric trains for street service composed of one car, for the following reasons:

First. Applications of the brake are likely to follow in such rapid succession that sufficient time would not be given to properly recharge the auxiliary or braking reservoir on each car.

Second. A graduated release or gradual decreasing brake-cylinder pressure is absolutely necessary in electric-car work, in order to obtain a smooth stop. With the standard automatic equipment, release of the brake-cylinder pressure is complete, when once started.

Third. A prompt response of the brakes when re-applied after a release is very essential. This is not always possible in the standard automatic equipment, since the auxiliary reservoir is very slow in charging.

To overcome these difficulties, there has been devised an automatic system for electric-car work, having quick-service, graduated-

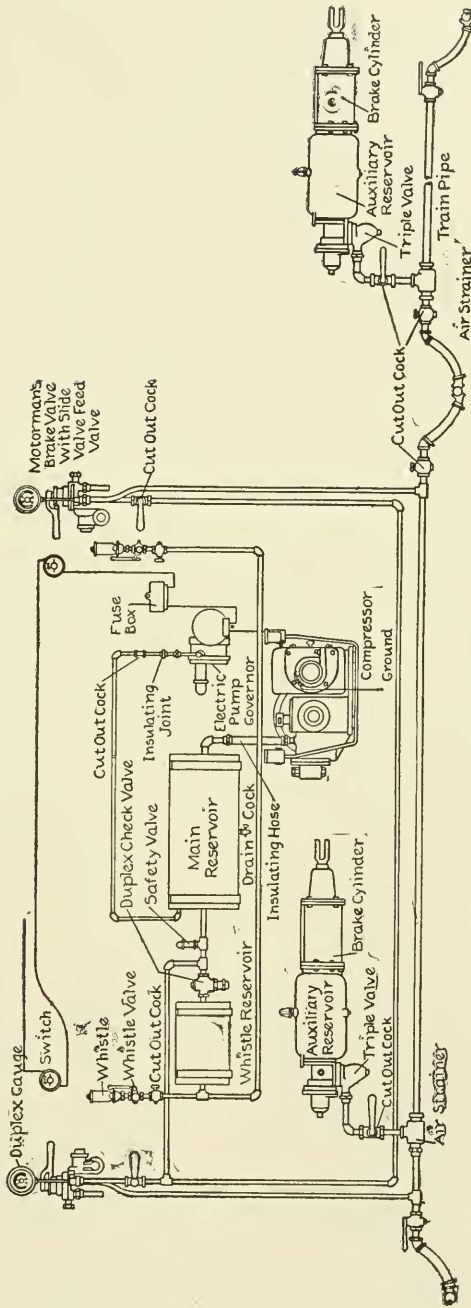

Fig. 99. Piping Diagram of the Westinghouse Automatic Friction Brake Equipment

release, and quick-recharging features. This system is very important for a certain class of service, but will not be described.

Train Air Signal. As the size of electric cars and the length of trains increase, a signal system becomes more and more a necessity.

Stopping a Car. The brake equipment of all electric cars is calculated with reference to the unloaded weight of the car, *i. e.*, the parts are so designed that there will be no danger of slipping the wheels when the car is unloaded. In stopping a car, the forces which

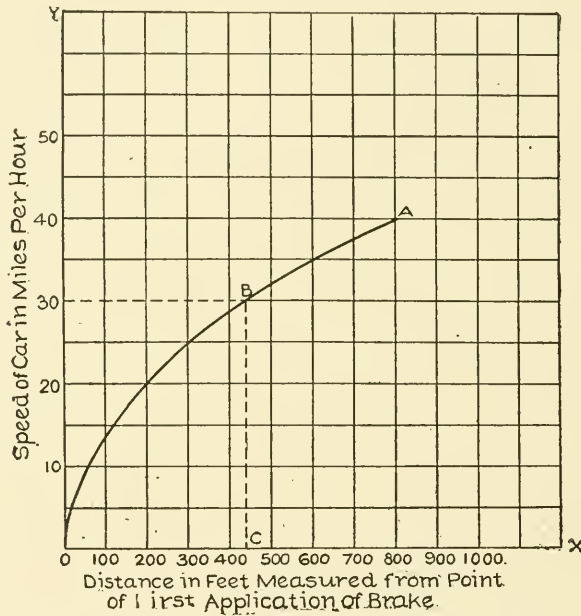
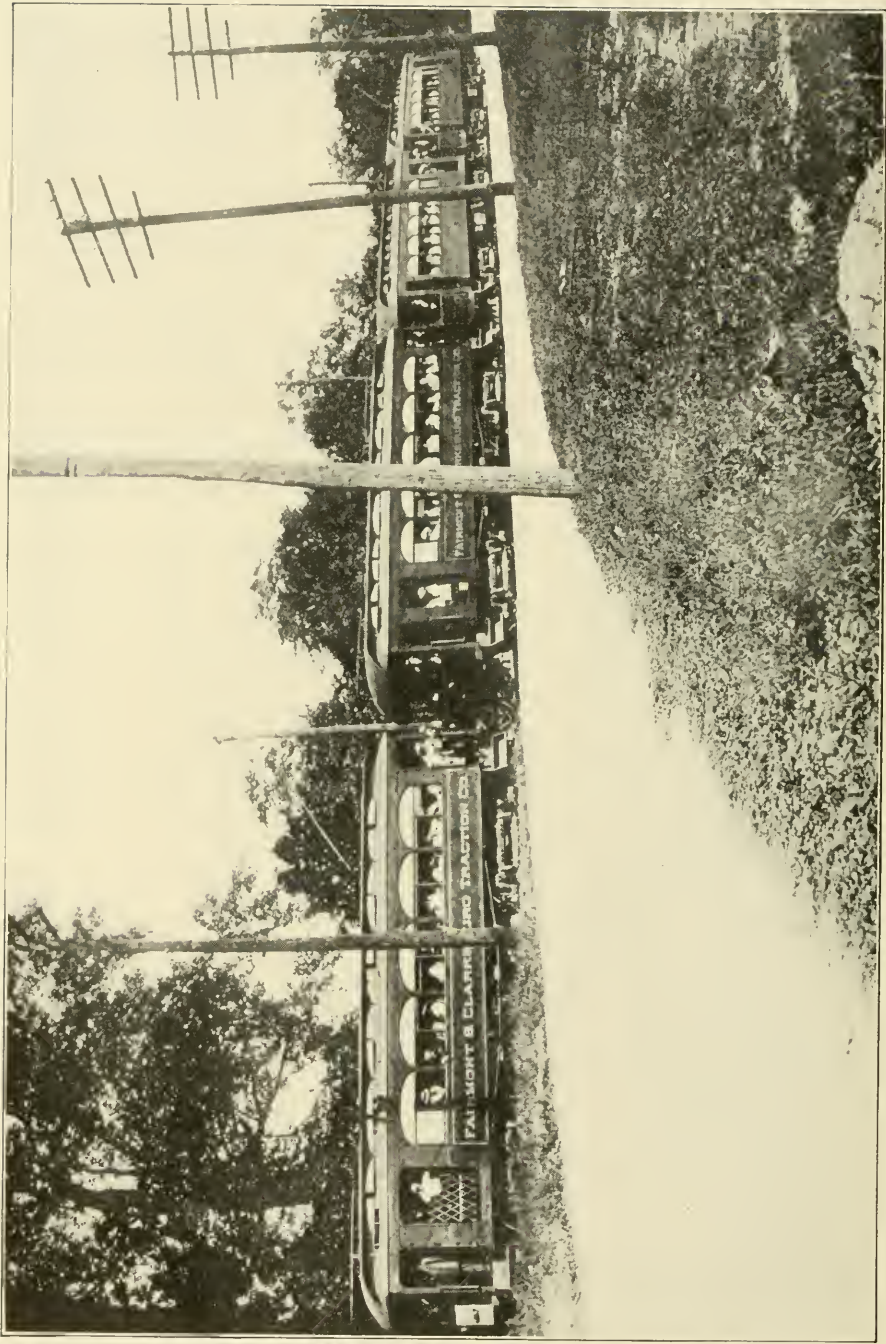

Fig. 100. Graph of Relation Between Speed of Car and Distance Required to Stop Car

act to retard its motion are: (a) the resistance of the atmosphere; (b) the frictional resistance of the journals and track; and (c) the resistance of the brake-shoes on the wheels.

When the brake is applied, the car pitches forward on the front truck, and the weight on the rear truck is thereby decreased. If proper allowances have not been made in proportioning the brake levers, the rear wheels will probably slip on the track, in which case it will require a greater distance in which to bring the car to rest. In bringing a car to rest, the energy of translation of the entire



FOUR-CAR TROLLEY TRAIN FOR INTERURBAN SERVICE WITH WESTINGHOUSE MOTORS AND MULTIPLE CONTROL SYSTEM

Courtesy of Westinghouse Electric and Manufacturing Company

car and the energy of rotation of all the wheels and motors must be absorbed by friction. To do this efficiently and safely in the shortest possible time, is the purpose of the modern brake systems.

The average person who rides on street and interurban cars knows nothing as to the distance in which these cars can be stopped. "In what distance can a modern double-truck electric car be stopped?" is a question which is frequently asked. In answer to this question, Fig. 100 has been prepared. A great many experiments have been made in stopping cars, with varying results. The chief factors which affect the results of such tests are the condition of the rail and the character of the material composing the brake-shoes. Fig. 100 shows graphically the relation between the distance required to stop a car and the speed (in miles per hour) at the instant the brake was applied. It represents the average result of a large number of experiments with a double-truck car fitted with brake equipment as described in the preceding pages. With perfect conditions, the curve ABO would fall above that shown, while with very poor conditions, it would fall lower. The value of the diagram is made apparent by the following application:

Example. Find the distance in which a double-truck electric car may be stopped if power is shut off and the brake applied while running at a speed of 30 miles per hour.

SOLUTION. Starting on the vertical line OY at 30 miles per hour, follow the horizontal line to the right until the curve ABO is reached at the point B . From the point B , follow the vertical line downward until the horizontal line OX is reached at the point C . This point C indicates the distance in feet in which the car may be stopped, which in this instance is 440 feet. In the same way, the stopping distances may be determined for cars running at any speed.

MISCELLANEOUS CAR EQUIPMENT

Trolley. Current is taken from the trolley wire through a brass wheel carried in a trolley harp mounted on the end of a light tubular steel pole. The pole is attached at its lower end to the trolley base, which is a spring hinge, pivoted on a base plate.

Base. Typical trolley bases are shown in Figs 101, 102, and 103. While these differ in detail they all operate upon the principle of producing a uniform pressure of the wheel on the wire regardless of the position of the pole. Some means of adjusting the tension is provided. In Fig. 101 are the following essential parts: The *stand*,

or *foot*, which is screwed to a small platform on the roof of the car and which is provided with a terminal binding clamp through which the current is carried to the pole and wheel; an *arm*, or *swivel*, one

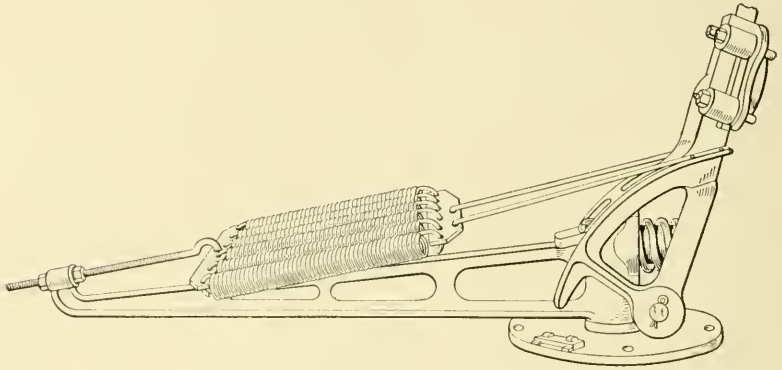

Fig. 101. Type of Trolley Base

end of which is drilled to fit over a swivel pin which forms part of the stand; a *pole socket* which is hinged at the lower end to the swivel arm on the pole socket axle pin—the pole socket also carries a pair of cams to which flexible bands for transmitting the tension from the springs are attached; a *set of springs* attached at one end

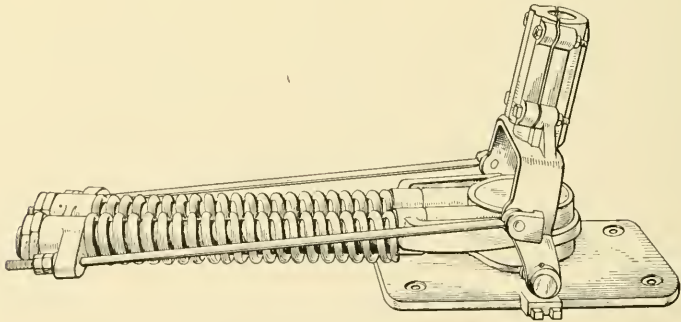

Fig. 102. Trolley Base with Ball-Bearing

by the flexible bands to the pole socket and at the other end, through an eye bolt and adjusting nuts, to the end of the arm; a *buffer spring* to absorb the shock in case the pole flies up suddenly.

The purpose of the cam which forms part of the pole socket is to increase the length of the lever arm, upon which the springs act,

as the pole rises toward a vertical position. The nearer the pole is to this position the greater is the torque required to produce the desired vertical pressure of the wheel on the wire. The reason for mounting the arm on the swivel pin is to allow the wheel to follow the trolley wire on curves and to permit the turning of the pole when the direction of motion of the car is to be reversed.

In order to allow the swivel arm to swing freely many modern trolley bases are provided with ball bearings instead of the swivel pin bearings. Such a base is shown in Fig. 102. In this base the same general prin-

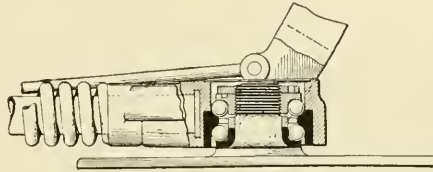

Fig. 103. Ball-Bearing of Fig. 102 in Detail

ciples are found but the springs are in compression instead of in tension as in the preceding case. The ball bearing is shown in Fig. 103. The stand or foot carries a vertical threaded stud on which are the upper and lower ball races or rings, with a nut at the top to permit of adjustment of the position of the upper race. The outer ball race is carried by the swivel. This mounting gives practically a frictionless support for the swivel and pole socket.

Pole. Trolley poles are made of light, high-grade steel tubing about $\frac{1}{2}$ inch in thickness and of a length determined by the height of the trolley wire above the car roof. The angular elevation of the trolley pole may be approximately 30 degrees. This will require poles between 12 and 18 feet in length. The steel of the poles is reasonably soft so that in general they will bend rather than break under ordinary shocks. The tubes are tapered from a point several feet from the upper end and they have an outside diameter at the butt from $1\frac{1}{2}$ to 2 inches. The standard outside diameter at the upper end is 1 inch, the inside being reamed to fit the standard harp shank. At the butt end the poles are reinforced by a length of tube inside, the length and strength of this being determined by the service to which the poles will be subjected.

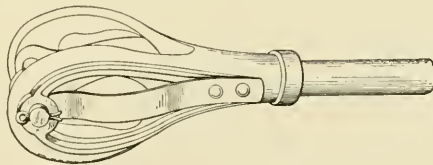

Fig. 104. Trolley Harp for Holding Pulley

Harp. The trolley harp is the device which is mounted on the upper end of the pole to carry the trolley wheel. A typical harp is

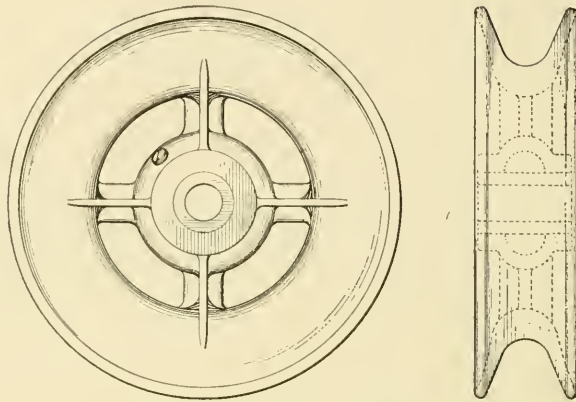

Fig. 105. Typical Trolley Wheel

shown in Fig. 104. The harp is a brass or malleable iron casting, or it may be of drop forged steel. It is provided with a cold rolled-steel shank, finished carefully to standard size, which slips into the reamed hole in the upper end of the trolley pole, where it is riveted into place. At the upper part of the harp is an axle pin upon which revolves the trolley wheel. Contact springs are also provided for conducting the current from the wheel to the pole.

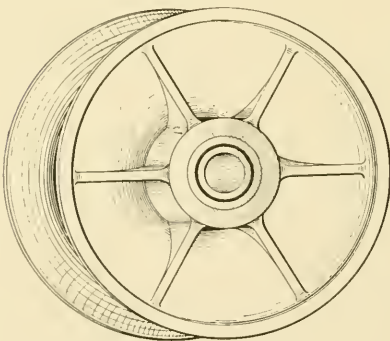

Fig. 106. Perspective View of Good Type of Trolley Wheel

Wheel. The trolley wheel is cast from brass of special composition satisfactory as to toughness and wearing qualities. The wheels are grooved as shown in Fig. 105, the grooves being of such form as to prevent the wheel from leaving the wire and at the same time to give sufficient clearance

so that the wheel will not bind when the car is rounding curves. The wheels are provided with graphite bushings so that they will be self-lubricating, and in some cases oil reservoirs are cast in the

hubs to furnish additional lubrication. The diameter of the wheels is determined by the speed at which they are to be operated, larger wheels being used for higher speeds. The diameter is from 4 to 5 inches for low-speed wheels and it may be 6 inches or over for use on high-speed interurban cars. Fig. 106 shows in perspective the usual form of wheel used in cars of moderate size. Fig. 107 is a wheel used in cutting sleet from the trolley wire.

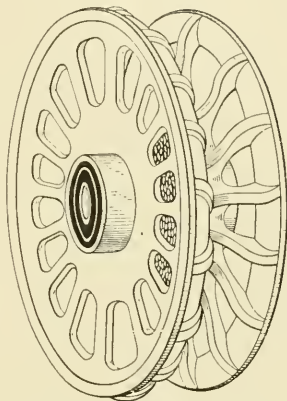

Fig. 107. Special Form of Trolley Wheel for Cutting Sleet

Catcher and Retriever. It is necessary to have some arrangement for preventing the trolley pole from flying up in case the wheel leaves the wire. If this happens and there is no "catcher" or "retriever" to hold the pole, the latter is likely to strike a span wire and be broken or badly bent. A simple, recent device for catching the trolley wheel and returning it to its place is shown in Fig. 108. A spirally-grooved aluminum piece is placed on each side of the trolley wheel, the spirals being right- and left-handed, respectively. The tendency of the whole device is to center itself on the wire. Whether or not this device will meet with favor it is impossible to say, but it is an interesting suggestion.

The standard forms of trolley catcher are more or less like that shown in Fig. 109. The trolley rope is wound about a drum or reel mounted in an iron box on the back of the car. This drum is rotated by a spring of moderate strength which keeps the slack rope wound up, but does not tend to pull the wheel off the wire. On the drum is a pair of pawls which are normally held close to it by springs. If, however, the rope is jerked suddenly, as it is when the trolley wheel slips off the wire, the pawls are thrown outward by centrifugal force and catch in lugs which are cast in the back of the case.

A retriever is a device which not only catches the trolley rope but winds it up until the trolley wheel is below its normal position, and, therefore, entirely clear of span wires and other obstructions. The usual form of retriever contains two springs, the *tension spring* for taking up the slack in the wire, and the *retrieving spring*, much

stronger than the other, for drawing the pole down. Normally the tension spring only is in operation. When the trolley rope is jerked, a centrifugal force is applied to a weight or governor which connects the reel with the retrieving spring and releases the latter. When the trolley wheel is replaced on the wire the conductor draws out the rope and winds the retrieving spring and latches it in its wound-up position ready for use again. As compared with the simple catcher, the retriever costs much more, but the expense is probably justified in high-speed work.

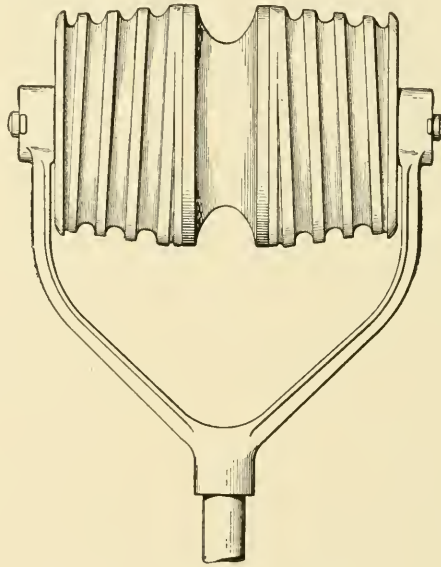

Fig. 108. Trolley Catcher with Spiral Groove

Heaters. Electric cars are heated by electric heaters (coils of wire of fairly high resistance) and by hot water. The former method, although wasteful of power, is preferred in city cars on account of its convenience.

Electric. Electric heaters are of the open-coil type, such as is shown in Fig. 110, or of the enamel type, shown in Fig. 111. A heater of the open-coil type is merely a number of coils of iron or other high-resistance wire mounted on non-combustible supports such as porcelain knobs. The coils are placed in a well-ventilated iron case to protect them from mechanical injury and to prevent contact with the clothing of passengers.

The enamel heaters have the resistance wire covered with enamel and thus protected from the air. The enamel prevents oxidation and permits the use of higher current densities than the open-

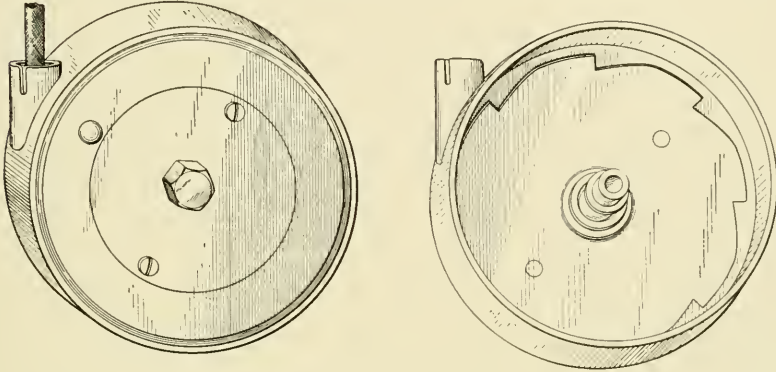

Fig. 109. Form of Trolley Catcher with Drum and Reel

coil type without rapid deterioration of the wire. The enamel heaters are, therefore, more compact and are used where there is little space for them.

Electric heaters are usually provided with coils of different resistance and, therefore, with different heating ability. It is thus possible to graduate the amount of heat produced by means of switches in the heater circuits. A sample wiring arrangement is given in Fig. 112.

The Consolidated Car Heating Company gives in Table II data on the current required to heat ears, while Table III gives results of heating tests made on Brooklyn cars.

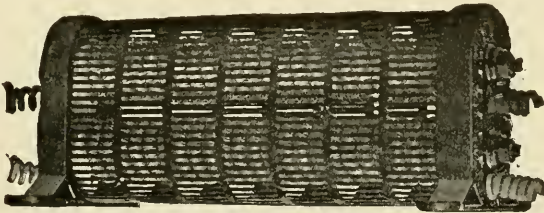

Fig. 110. Open-Coil Type of Car Heater

Hot-Water. Hot-water heaters are frequently used on large electric cars. Hot-water pipes are placed along the sides of the car,

TABLE II
Car Heating Data

	LENGTH OF CAR BODY	AMPERES		
		SWITCH POSITIONS		
		1	2	3
Average conditions.....	14 to 20 feet	3	4	7
	20 to 28 feet	3	6	9
	28 to 34 feet	4	7	11
Severest conditions.....	18 to 24 feet	4	7	11
	28 to 34 feet	6	8	14

*TABLE III
Heat Tests on Brooklyn Cars

CARS			TEMPERATURE F		CONSUMPTION	
DOORS	WINDOWS	CONTENTS CUBIC FEET	OUTSIDE	AVERAGE IN CAR	WATTS	AMPERES AT 500 VOLTS
2	12	850 $\frac{1}{2}$	28	55	2295	4.6
2	12	850 $\frac{1}{2}$	7	39	2325	4.6
2	12	808 $\frac{1}{2}$	28	49	2180	4.3
2	12	913 $\frac{1}{2}$	35	52	2745	4.5
4	16	1012	7	46	3038	6.
4	16	1012	28	54	3160	6.3

*Foster's "Electrical Engineers' Handbook."

and connected with a stove containing hot-water coils at one end of the car. The water, as it is heated in the stove or heater, expands, and consequently becomes lighter per cubic inch or other unit of volume; it, therefore, tends to rise when balanced against the colder water in the car pipes. Hot water leaves the top of the heater, flows up to an expansion tank and then down through the car piping, and back to the bottom of the heater. The car piping slopes continuously down from the top connection to the bottom connection of the heater. At the top, an opening to the atmosphere is provided through a small water tank, called an *expansion tank*. This prevents water-pressure bursting the pipes as they become heated, and allows any steam that may have formed, to escape. The most modern hot-water heaters for cars are completely closed except as to the ash pit at the bottom and a small feed door in the top. The latter is locked so that the fire cannot come out even if the car is

tipped over in a wreck. Fig. 113 shows the pipes of a hot-water heating installation.

Lighting System. The incandescent lamps in a car are usually connected in series and lamps of the proper voltage are selected to

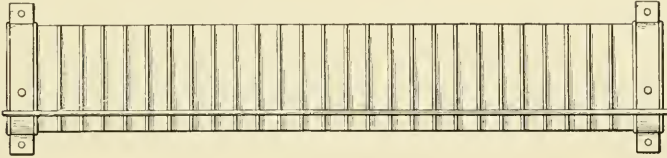

Fig. 111. Enamel Type of Electric Heater

fit the requirements. For example, if there are four inside lamps and a headlight and the trolley voltage is 550, 110-volt lamps are selected. Large cars requiring, say, eight inside lamps are supplied with two lamp circuits in parallel. A sample wiring diagram is shown in Fig. 114.

Lamps. Lamps for this service have to be selected very carefully for uniformity of current consumption at rated voltage, for when connected in series they receive the same current. If the lamps are not carefully matched, the voltage drops in the several lamps

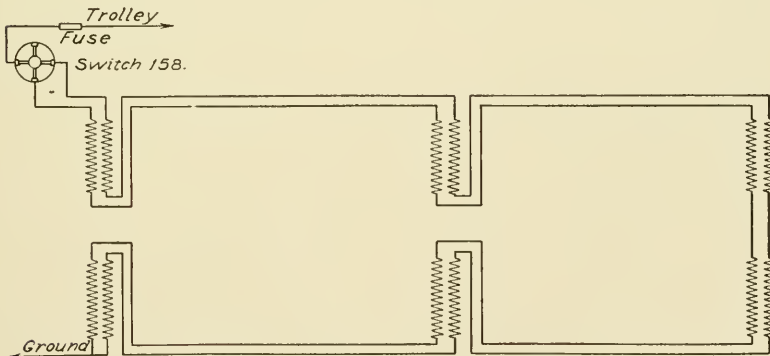

Fig. 112. Diagram of Car Heater Circuits

in the series will not be uniform and the candle power and life of each will be different. As car lamps are subjected to constant vibration, the filaments cannot be operated at as high a temperature as those in stationary service. A rather high specific power consumption, from 3.6 to 4 watts per candle power, is, therefore, usual.

Headlights. For the headlights special flat-spiral filaments have been developed so that the light can be concentrated near the

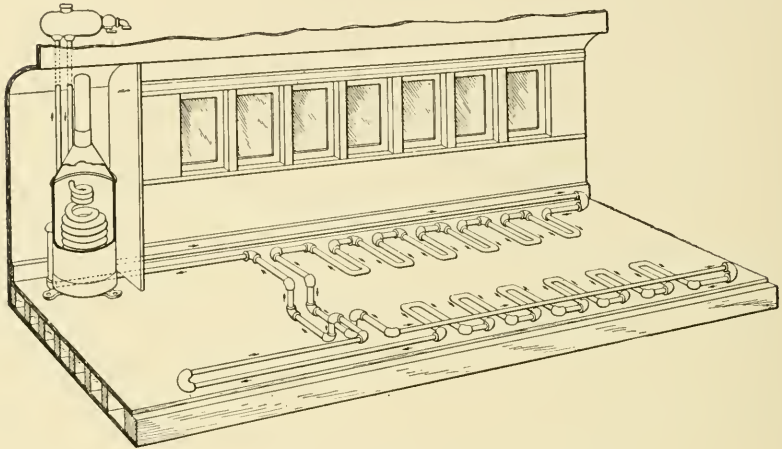

Fig. 113. Diagram of Hot-Water Heating Installation

focus of the parabolic mirror. A cross-section of an incandescent headlight is shown in Fig. 115. It consists of a drawn steel jacket enclosing a spun aluminum parabolic mirror, highly polished. The jacket also supports the brass door frame enclosing a double-thick

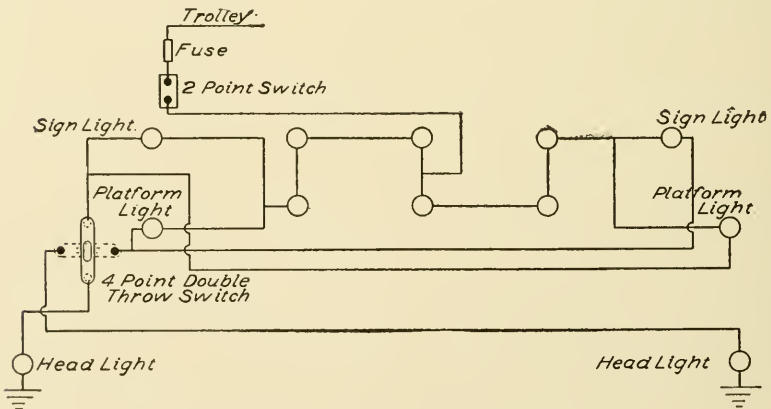

Fig. 114. Wiring Diagram for Car Lighting System

glass. Attached to the jacket is a plug of insulating material which carries contacts electrically connected to the lamp terminals. The

plug drops into a socket on the dashboard of the car, automatically connecting the lamp terminals in the circuit.

Arc headlights are used in interurban service when it is desired to illuminate a long stretch of track ahead of the car. A cross-section of such a lamp is shown in Fig. 116. The arc lamp is a simple gravity feed lamp, the feed being controlled by the solenoid and plunger. The lower carbon has no automatic feeding mechanism

but the position of the arc is adjusted by hand through a friction wheel operated by a knurled head. The operation of the lamp is as follows: The current flows through a controlling resistance, through the carbons and across the arc, through the flexible connecting wire, and through the control magnet coil, all in series. The clutch is a piece of porcelain with a hole slightly larger than the upper carbon. The form of the clutch is seen in the figure. At one end it is pivoted to a link connecting with the lever operated by the magnet core. The other end is held in place by a spring. When the magnet coil is energized by an excessive current the core is attracted and through the levers one end of the clutch is raised. It binds on the carbon and raises it, thus lengthening the arc.

When the arc burns to such a length as to cut down the current by the increase of resistance, the coil releases the core, the clutch returns to the position shown, and the upper carbon slips down until current is increased sufficiently to raise the clutch again, thus maintaining a constant arc length.

As most interurban cars operate in both country and city, and as the arc lamp is very objectionable in the city, a combination of arc and

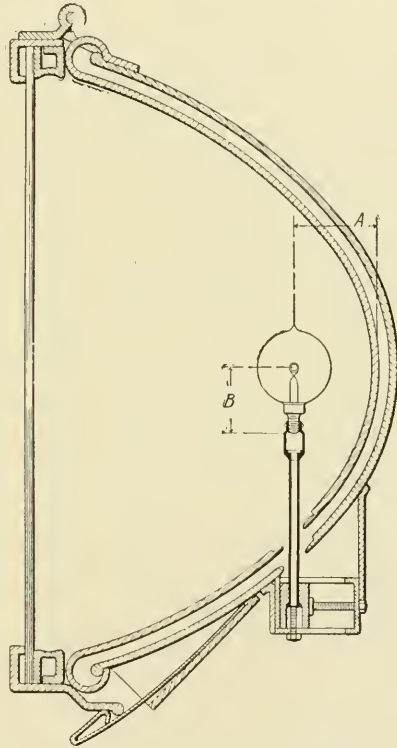

Fig. 115. Section of Incandescent Headlight

incandescent headlights is employed. The two lamps may be conveniently located in the same reflector, although in this arrangement it is impossible to have both lamps at the focus of the reflector. A two-way switch permits the motorman to switch on whichever lamp is desired.

Car-Wiring System. The car-wiring diagrams studied earlier in the course indicate the motor and control circuits which have to be installed. In addition there are the heating and the lighting circuits, the compressor circuits, and in some cases the bell circuits. In cars of moderate size it is customary to bunch the motor-circuit

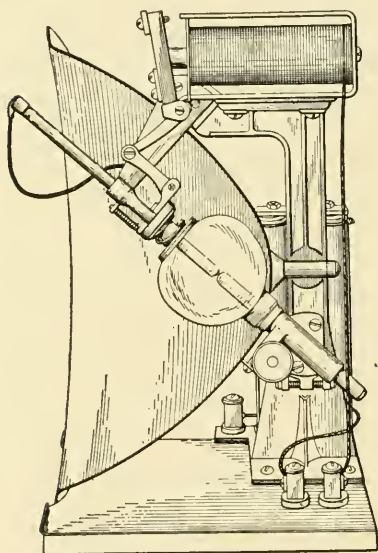

Fig. 116. Section of Arc Headlight

wires into cables of convenient size for handling and to cover these with a special form of heavy canvas hose called "car cable hose". This receives a number of coats of insulating paint. These cables are secured under the car. The other wiring is usually in wooden molding.

A much better class of wiring, such as is used on large double-truck cars, is conduit wiring. Iron enameled conduits enclosing the wires are attached securely to the bottom of the car. These afford first-class mechanical protection and decrease fire risk.

The methods of car wiring in present use have been determined partly by the experience of car operators and partly from the suggestions of the insurance companies.

As railway companies naturally desire to insure their cars, the insurance companies have practically the same jurisdiction over cars that they have over buildings because they can refuse insurance if they consider a car an unnecessarily hazardous fire risk. Section No. 32 of the "National Electrical Code" is devoted to "Car Wiring and Equipment of Cars". It is necessary, therefore, that the student be familiar with this section of the code if he is to understand the reasons for certain details of present practice. The section is as follows:

CAR WIRING AND EQUIPMENT OF CARS

(A) *Protection of Car Body, etc.*

(1) Under side of car bodies to be protected by *approved* fire-resisting, insulating material, not less than $\frac{1}{8}$ inch in thickness, or by sheet iron or steel, not less than .04 inch in thickness, as specified in Section (a) 2, 3, and 4. This protection to be provided over all electrical apparatus, such as motors with a capacity of over 75 h. p. each, resistances, contactors, lightning arresters, air-brake motors, etc., and also where wires are run, except that protection may be omitted over wires designed to carry 25 amperes or less if they are encased in metal conduit.

(2) At motors of over 75 h. p. each, fire-resisting material or sheet iron or steel to extend not less than 8 inches beyond all edges of openings in motors, and not less than 6 inches beyond motor leads on all sides.

(3) Over resistances, contactors, and lightning arresters, and other electrical apparatus, excepting when amply protected by their casing, fire-resisting material or sheet iron or steel to extend not less than 8 inches beyond all edges of the devices.

(4) Over conductors, not encased in conduit, and conductors in conduit when designed to carry over 25 amperes, unless the conduit is so supported as to give not less than $\frac{1}{2}$ inch clear air space between the conduit and the car, fire-resisting material or sheet iron or steel to extend at least 6 inches beyond conductors on either side.

The fire-resisting insulating material or sheet iron or steel may be omitted over cables made up of flameproof braided outer covering when surrounded by $\frac{1}{8}$ inch flameproof covering, as called for by Section (i) 4.

(5) In all cases fireproof material or sheet iron or steel to have joints well fitted, to be securely fastened to the sills, floor timbers and cross braces, and to have the whole surface treated with a waterproof paint.

(6) Cut-out and switch cabinets to be substantially made of hard wood. The entire inside of cabinet to be lined with not less than $\frac{1}{8}$ inch fire-resisting insulating material which shall be securely fastened to the woodwork, and after the fire-resisting material is in place the inside of the cabinet shall be treated with a waterproof paint.

(B) *Wires, Cables, etc.*

(1) All conductors to be stranded, the allowable carrying capacity being determined by Table "A" of No. 16, except that motor, trolley and resistance leads shall not be less than No. 7 B. & S. gauge, heater circuits not less than No. 12 B. & S. gauge, and lighting and other auxiliary circuits not less than No. 14 B. & S. gauge.

The current used in determining the size of motor, trolley, and resistance leads shall be the per cent of the full load current, based on one hour's run of the motor, as follows:

SIZE EACH MOTOR	MOTOR LEADS	TROLLEY LEADS	RESISTANCE LEADS
75 h. p. or less	50%	40%	15%
Over 75 h. p.	45%	35%	15%

Approved fixture wire will be permitted for wiring *approved* clusters.

(2) To have an insulation and braid *approved* for wires carrying currents of the same potential.

(3) When run in metal conduit, to be protected by an additional braid.

Where conductors are laid in conduit, not being drawn through, the additional braid will not be required.

(4) When not in conduit, in *approved* molding, or in cables surrounded by $\frac{1}{8}$ inch flameproof covering, must be *approved* rubber covered (except that tape may be substituted for braid) and be protected by an additional flameproof braid, at least $\frac{3}{32}$ inch in thickness, the outside being saturated with a preservative flameproof compound. Except that when motors are so enclosed that flame cannot extend outside of the casing, the flameproof covering will not be required on the motor leads.

(5) Must be so spliced or joined as to be both mechanically and electrically secure without solder. The joints must then be soldered and covered with an insulation equal to that on the conductors.

Joints made with *approved* splicing devices and those connecting the leads at motors, plows, or third rail shoes need not be soldered.

(6) All connections of cables to cut-outs, switches and fittings, except those to controller connection boards, when designed to carry over 25 amperes, must be provided with lugs or terminals soldered to the cable, and securely fastened to the device, by bolts, screws or by clamping; or, the end of the cable, after the insulation is removed, shall be dipped in solder and be fastened into the device by at least two set screws having check nuts.

All connections for conductors to fittings, etc., designed to carry less than 25 amperes, must be provided with up-turned lugs that will grip the conductor between the screw and the lug, the screws being provided with flat washers; or by block terminals having two set screws, and the end of the conductors must be dipped in solder. Soldering, in addition to the connection of the binding screws, is strongly recommended, and will be insisted on when above requirements are not complied with.

This rule only to apply to circuits where the maximum potential is over 25 volts and current exceeds 5 amperes

(c) *Cut-outs, Circuit Breakers, and Switches.*

(1) All cut-outs and switches having exposed live metal parts to be located in cabinets. Cut-outs and switches, not in iron boxes or in cabinets, shall be mounted on not less than $\frac{1}{4}$ inch fire-resisting insulating material, which shall project at least $\frac{1}{2}$ inch beyond all sides of the cut-out or switch.

(2) Cut-outs to be of the *approved* cartridge or *approved* blow-out type.

(3) All switches controlling circuits of over 5 ampere capacity

shall be of *approved* single pole, quick break or *approved* magnetic blow-out type.

Switches controlling circuits of 5 ampere or less capacity may be of the *approved* single pole, double break, snap type.

- (4) Circuit breakers to be of *approved* type.
- (5) Circuits must not be fused above their safe carrying capacity.
- (6) A cut-out must be placed as near as possible to the current collector, so that the opening of the fuse in this cut-out will cut off all current from the car.

When cars are operated by metallic return circuits, with circuit breakers connected to both sides of the circuit, no fuses in addition to the circuit breakers will be required.

(d) *Conduit.*

When from the nature of the case, or on account of the size of the conductors, the ordinary pipe and junction box construction is not permissible, a special form of conduit system may be used, provided the general requirements as given below are complied with.

(1) Metal conduits, outlet and junction boxes to be constructed in accordance with standard requirements except that conduit for lighting circuits need not be over $\frac{5}{16}$ inch internal diameter and $\frac{1}{2}$ inch external diameter, and for heating and air motor circuits need not be over $\frac{3}{8}$ inch internal diameter and $\frac{9}{16}$ inch external diameter, and all conduits where exposed to dampness must be water tight.

(2) Must be continuous between and be firmly secured into all outlet or junction boxes and fittings, making a thorough mechanical and electrical connection between same.

(3) Metal conduits, where they enter all outlet or junction boxes and fittings, must be provided with *approved* bushings fitted so as to protect cables from abrasion.

(4) Except as noted in Section *i*, 2, must have the metal of the conduit permanently and effectively grounded.

(5) Junction and outlet boxes must be installed in such a manner as to be accessible.

(6) All conduits, outlets or junction boxes and fittings to be firmly and substantially fastened to the framework of the car.

(e) *Molding.*

(1) To consist of a backing and a capping and to be constructed of fire-resisting insulating material, except that it may be made of hard wood where the circuits which it is designed to support are normally not exposed to moisture.

(2) When constructed of fire-resisting insulating material, the backing shall be not less than $\frac{1}{4}$ inch in thickness and be of a width sufficient to extend not less than 1 inch beyond conductors at sides.

The capping, to be not less than $\frac{1}{8}$ inch in thickness shall cover and extend at least $\frac{3}{4}$ inch beyond conductors on either side.

The joints in the molding shall be mitred to fit close, the whole material being firmly secured in place by screws or nails, and treated on the inside and outside with a waterproof paint.

When fire-resisting molding is used over surfaces already protected by $\frac{1}{8}$ inch fire-resisting insulating material no backing will be required.

(3) Wooden moldings must be so constructed as to thoroughly encase the wire and provide a thickness of not less than $\frac{3}{8}$ inch at the sides and back of the conductors, the capping being not less than $\frac{3}{16}$ inch in thickness. Must have two coats of waterproof paint both outside and inside.

The backing and the capping shall be secured in place by screws.

(F) *Lighting and Lighting Circuits*

(1) Each outlet to be provided with an *approved* receptacle, or an *approved* cluster. No lamp consuming more than 128 watts to be used.

(2) Circuits to be run in *approved* metal conduit, or *approved* molding.

(3) When metal conduit is used, except for sign lights, all outlets to be provided with *approved* outlet boxes.

(4) At outlet boxes, except where *approved* clusters are used, receptacles to be fastened to the inside of the box, and the metal cover to have an insulating bushing around opening for the lamp.

When *approved* clusters are used, the cluster shall be thoroughly insulated from the metal conduit, being mounted on a block of hard wood or fire-resisting insulating material.

(5) Where conductors are run in molding the receptacles or cluster to be mounted on blocks of hard wood or of fireproof insulating material.

(G) *Heaters and Heating Circuits*

(1) Heaters to be of *approved* type.

(2) Panel heaters to be so constructed and located that when heaters are in place all current-carrying parts will be at least 4 inches from all woodwork.

Heaters for cross seats to be so located that current-carrying parts will be at least 6 inches below under side of seat, unless under side of seat is protected by not less than $\frac{1}{4}$ inch fire-resisting insulating material, or .04 inch sheet metal with 1 inch air space over same, when the distance may be reduced to 3 inches.

Truss plank heaters to be mounted on not less than $\frac{1}{4}$ inch fire-resisting insulating material, the legs or supports for the heaters providing an air space of not less than $\frac{1}{2}$ inch between the back of the heater and the insulating material.

(3) Circuits to be run in *approved* metal conduit, or in *approved* molding, or if the location of conductors is such as will permit an air space of not less than 2 inches on all sides except from the surface wired over, they may be supported on porcelain knobs or cleats, provided the knobs or cleats are mounted on not less than $\frac{1}{4}$ inch fire-resisting insulating material extending at least 3 inches beyond conductors at either side, the supports raising the conductors not less than $\frac{1}{2}$ inch from the surface wired over, and being not over 12 inches apart.

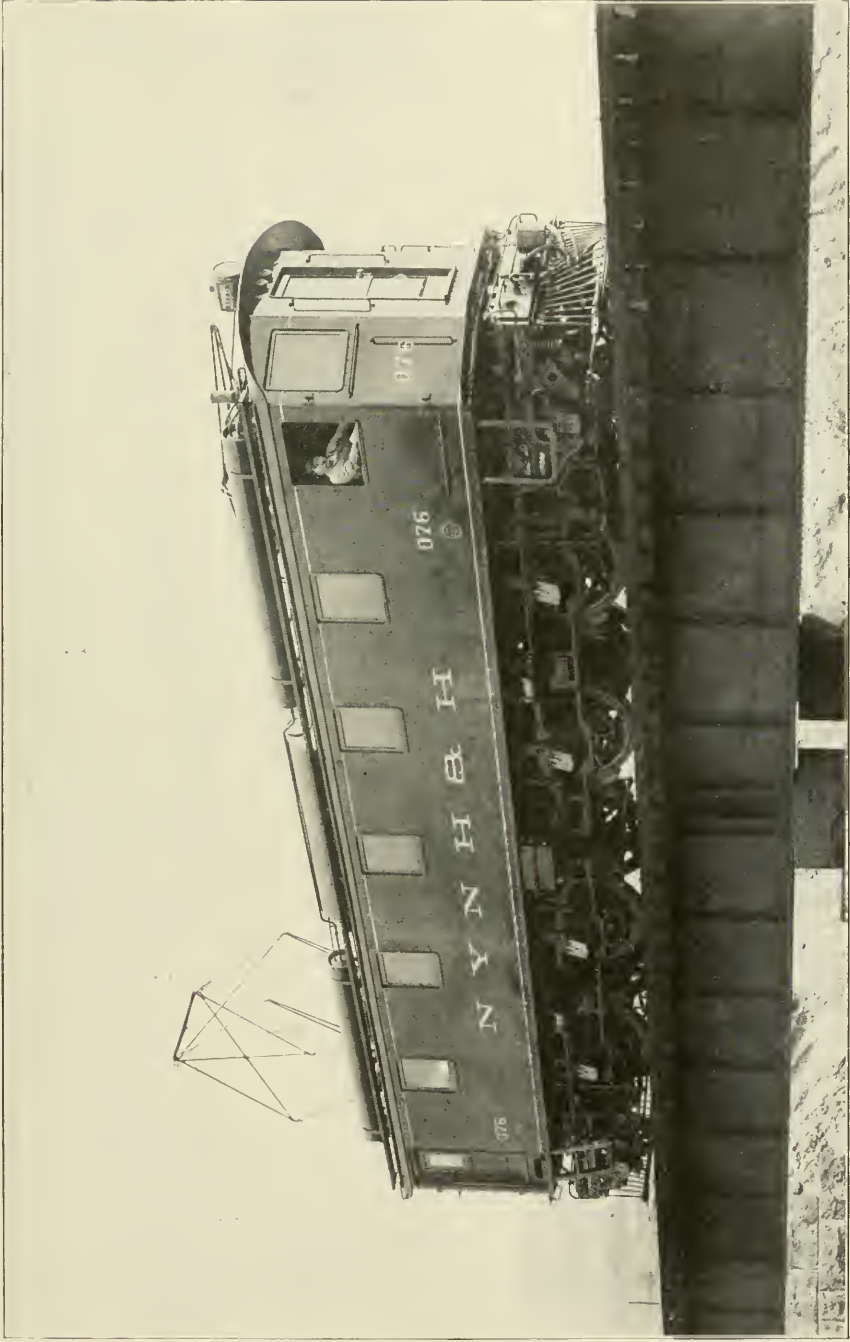

ELECTRIC PASSENGER LOCOMOTIVE IN USE ON NEW YORK, NEW HAVEN, AND HARTFORD ROADS
Courtesy of Westinghouse Electric and Manufacturing Company

(H) Air Pump Motor and Circuits

(1) Circuits to be run in *approved* metal conduit or in *approved* molding, except that when run below the floor of the car they may be supported on porcelain knobs or cleats, provided the supports raise the conductor at least $\frac{1}{2}$ inch from the surface wired over and are not over 12 inches apart.

(2) Automatic control to be enclosed in *approved* metal box. Air pump and motor, when enclosed, to be in *approved* metal box or a wooden box lined with metal of not less than $\frac{1}{32}$ inch in thickness.

When conductors are run in metal conduit the boxes surrounding automatic control and air pump and motor may serve as outlet boxes.

(I) Main Motor Circuits and Devices

(1) Conductors connecting between trolley stand and main cut-out or circuit breakers in hood to be protected where wires enter car to prevent ingress of moisture.

(2) Conductors connecting between third rail shoes on same truck, to be supported in an *approved* fire-resisting insulating molding or in *approved* iron conduit supported by soft rubber or other *approved* insulating cleats.

(3) Conductors on the under side of the car, except as noted in Section *i*, 4, to be supported in accordance with one of the following methods:

(a) To be run in *approved* metal conduit, junction boxes being provided where branches in conduit are made, and outlet boxes where conductors leave conduit.

(b) To be run in *approved* fire-resisting insulating molding.

(c) To be supported by insulating cleats, the supports being not over 12 inches apart.

(4) Conductors with flameproof braided outer covering, connecting between controllers at either end of car, or controllers and contactors, may be run as a cable, provided the cable where exposed to the weather is encased in a canvas hose or canvas tape, thoroughly taped or sewed at ends and where taps from the cable are made, and the hose or tape enters the controllers.

Conductors with or without flameproof braided outer covering connecting between controllers at either end of the car, or controllers and contactors, may be run as a cable, provided the cable throughout its entire length is surrounded by $\frac{1}{8}$ inch flameproof covering, thoroughly taped or sewed at ends, or where taps from cable are made, and the flameproof covering enters the controllers.

Cables where run below floor of car may be supported by *approved* insulating straps or cleats. Where run above floor of car, to be in a metal conduit or wooden box painted on the inside with not less than two coats of flameproof paint, and where this box is so placed that it is exposed to water, as by washing of the car floor, attention should be given to making the box reasonably waterproof.

Canvas hose or tape, or flameproof material surrounding cables after conductors are in same, to have not less than two coats of waterproof insulating material.

(5) Motors to be so drilled that, on double truck cars, connecting cables can leave motor on side nearest to king bolt.

(6) Resistances to be so located that there will be at least 6 inch air space between resistances proper and fire-resisting material of the car. To be mounted on iron supports, being insulated by non-combustible bushings or washers, or the iron supports shall have at least 2 inches of insulating surface between them and metal work of car, or the resistances may be mounted on hard wood bars, supported by iron stirrups, which shall have not less than 2 inches of insulating surface between foot of resistance and metal stirrup, the entire surface of the bar being covered with at least $\frac{1}{8}$ inch fire-resisting insulating material.

The insulation of the conductor, for about 6 inches from terminal of the resistance, should be replaced, if any insulation is necessary, by a porcelain bushing or asbestos sleeve.

(7) Controllers to be raised above platform of car by a not less than 1 inch hard wood block, the block being fitted and painted to prevent moisture working in between it and the platform.

(J) *Lightning Arresters*

(1) To be preferably located to protect all auxiliary circuits in addition to main motor circuits.

(2) The ground conductor shall be not less than No. 6 B. & S. gauge, run with as few kinks and bends as possible, and be securely grounded.

(K) *General Rules*

(1) When passing through floors, conductors or cables must be protected by *approved* insulating bushings, which shall fit the conductor or cable as closely as possible.

(2) Molding should never be concealed except where readily accessible. Conductors should never be tacked into molding.

(3) Short bends in conductors should be avoided where possible.

(4) Sharp edges in conduit or in molding must be smoothed to prevent injury to conductors.

Drawbars and Couplers. As cars are frequently used in trains some provision must be made for coupling them together. This matter is of such importance that the American Electric Railway Association has given it special attention, particularly with a view to standardizing the heights of couplers so that all cars of a given class may be coupled. Fig. 117 shows the arrangements recommended by the association, not only for couplers but for steps and bumpers.

The coupler for electric cars differs somewhat from that used in steam practice because such cars must round sharp curves, hence the coupler must have considerable sidewise play.

For small surface cars a crude drawbar is usually provided,

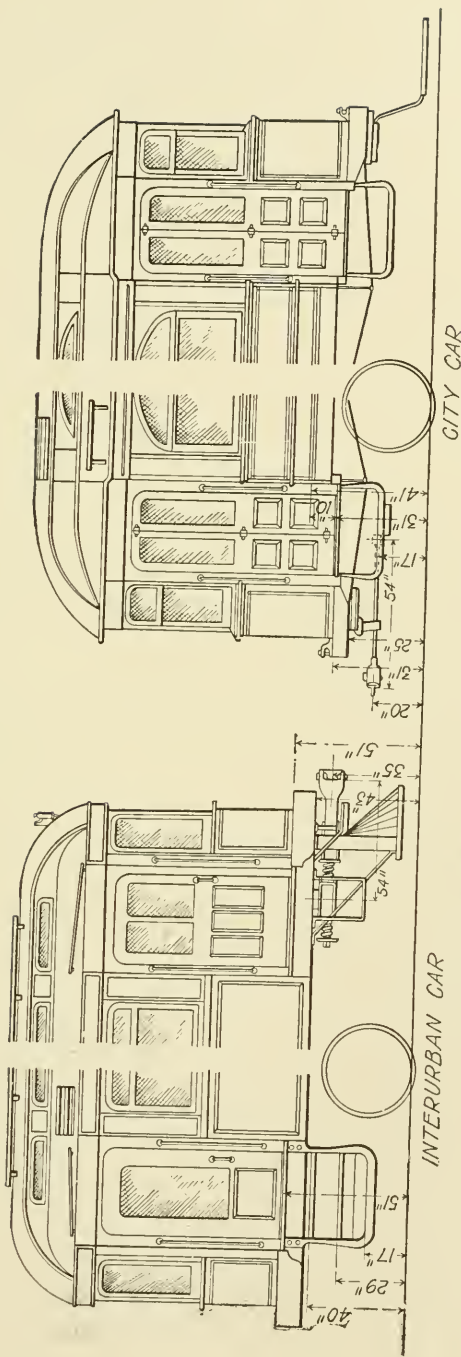

Fig. 117. Details of Coupler, Steps, and Bumpers of an Electric Car

consisting simply of a straight iron bar pivoted under the car and provided with a cast-iron pocket near the end. A coupling pin passing through the pocket of one coupler and through a hole in the end of the bar of the other, holds the two cars together.

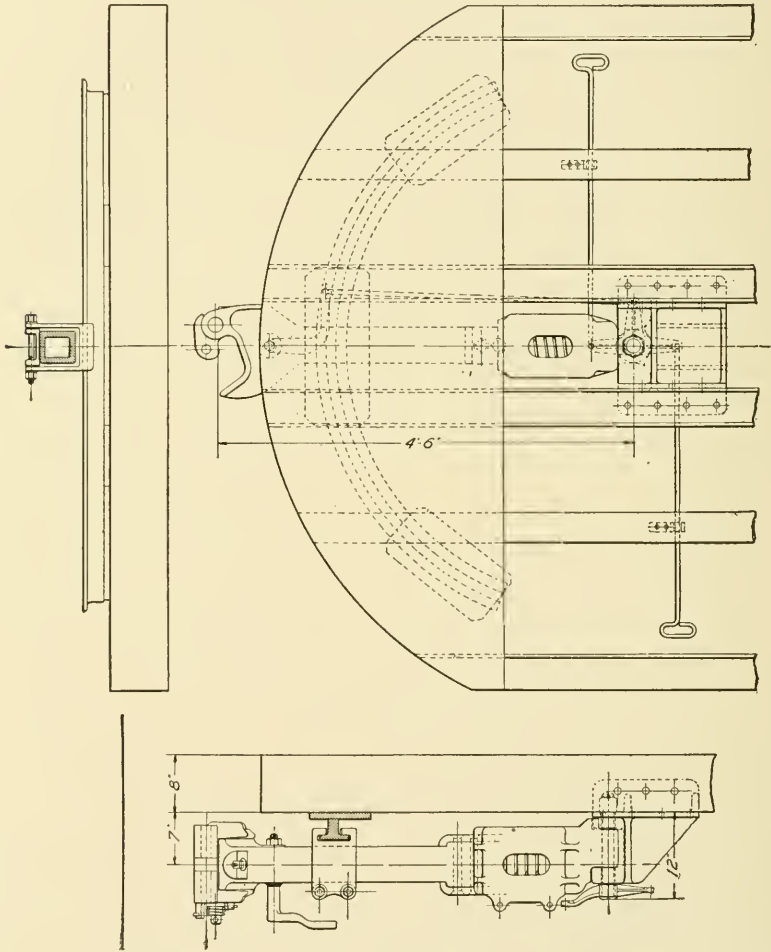

Fig. 118. Plan and Elevation of Standard M. C. B. Coupler

The requirements of a coupler for heavier cars such as those used on interurban and elevated roads and in subways are more exacting. The ends of the bars are usually pivoted under the car about 5 feet back from the bumper. This is shown clearly in Fig.

118, which represents an adaptation of the standard M. C. B. coupler to interurban electric railway conditions. This will be recognized as a modified Janney coupler, familiar in steam railroad practice. The coupler consists of a steel drawbar about $4\frac{1}{2}$ feet in length. It is pivoted from a strong bracket which is bolted firmly to the center sills of the underframe. It swivels on a pin carried by this bracket. At the opposite end of the drawbar is a knuckle which couples with a similar knuckle on the next car. The vertical dimension of the knuckle face is large, say 10 inches, so that cars may be coupled even if their couplers are not exactly on the same level. The weight of the drawbar at the outer end is supported by a curved carrying-iron bolted under the bumper. This coupler is partly automatic in its action as the two knuckles take the relative positions as shown in the dotted lines in the upper part of the figure. They are locked and unlocked by a simple lever system operated by the handles shown in the lower figure. It is not necessary for the operator to go between the cars.

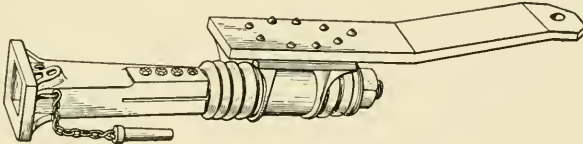

Fig. 119. Drawbar of a Simple Coupler

An important feature of these automatic couplers is the spring cushion at the pivot end of the bar, to prevent excessive shock when two cars come together. It is evident that the couplers have to take the entire shock in this case. The spring cushion is shown in Fig. 118 and still more plainly in Fig. 119 which shows the drawbar of a VanDorn coupler.

As this figure and the following one indicate, the VanDorn is a link coupler, which automatically couples and which is ordinarily uncoupled by withdrawing one of the pins. The head consists of a rectangular, flat-faced pocket, inside of which is a laminated spring. Holes are provided for dropping the rather flat coupling-pins into position. The links and pins are of drop forged steel and have the form shown in Fig. 120. The uppermost drawing in this figure represents a section of a complete coupler with the link firmly locked in position. Before coupling, the pin was placed in the right-hand

head in the position shown and then the two heads were brought together. The link pushed its way into the other head, pressing back the spring as shown in the middle figure, and hooking itself over the other pin which had been previously placed in the position indicated. When hooked over this pin the coupling of the cars is complete. There are numerous slight modifications of the coupler described but these show the essential features.

Rheostats. The starting resistance is provided by rheostats which are mounted under the car. An excellent type of rheostat for this work consists of east-iron grids of the form shown in Fig. 121. Fig. 122 shows details of a rheostat with a slightly different

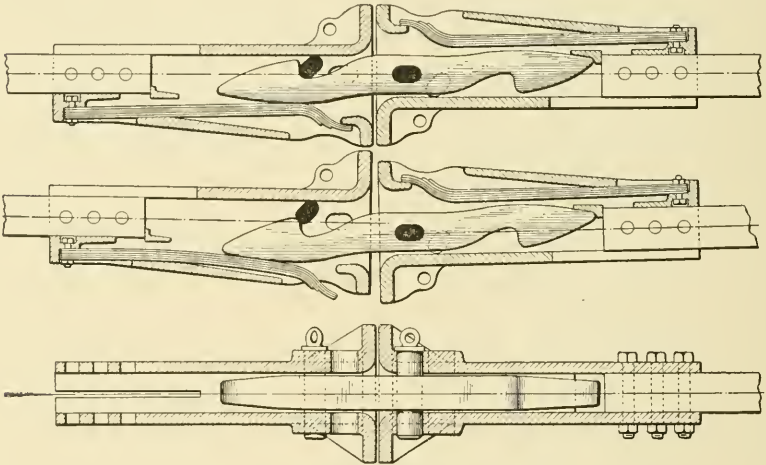

Fig. 120. Sectional Views of Link Coupler

form of grid. Each grid is a zigzag strip of iron with eyes on the ends and in the middle. The eyes form the supports for the grids and at the same time permit of convenient connection of the grids in series. The grids are covered with non-oxidizing metal to prevent rust to which they would be liable on account of their exposed location. The grids are assembled on mica-insulated bolts between end castings. In order to connect them in series, mica insulating washers are placed between alternate eyes on each side and between all of the center eyes so that the current is obliged to flow through all of the iron strip. Parallel connection of grids as well as series can be made by proper placing of the insulating washers. Electrical con-

nection to the grids is made through brass terminals of the form shown in the figure. These are provided with prongs which slip in between the eyes at the proper points, being held firmly in place by the clamp bolts.

The cast grids are made in standard sizes having resistances from about one-fiftieth ohm to one-sixth ohm each. Any desired number of grids can be assembled in a frame by using the proper bolt lengths. The low-resistance grid mentioned will carry 75 amperes continuously, or 150 amperes in intermittent service such as is usual in car operation. The high-resistance grid will carry 30 and 50 amperes, respectively. The ventilation of these grids is good as there is ample air space between the iron strips.

Track Sanders. A sprinkling of sand on the rails increases the adhesion between rails and wheels. There is usually on cars some provision made for scattering sand on the rails immediately in front of the leading wheels. From sand boxes placed under the seats in the smaller cars, or on the trucks of the larger ones, flexible hose or pipes drop within an inch or two of the rail in front of the leading wheels. A valve under the control of the motorman regulates the flow of

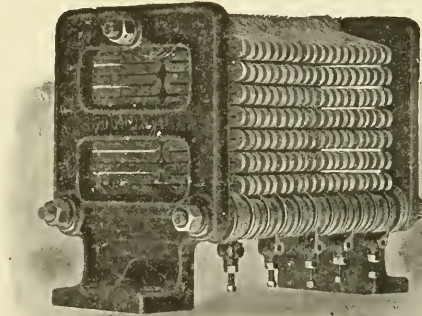

Fig. 121. Typical Rheostat with Cast-Iron Grids

sand to the rail. Sometimes air-pressure is used to blow the sand out of the sand box into the hose. In this case air-pressure is obtained from the air-brake system, and an air valve leading to the sand box is placed in the motorman's cab. A section through a pneumatic sander of this kind is shown in Fig. 123. Sand for use as above described has to be dried very carefully in order that it may flow freely.

Electrical Devices. *Canopy, or Hood, Switch.* An overhead switch, sometimes called a canopy switch, is commonly placed over each street-car platform where a controller is located, usually in the hood or canopy above the motorman's head. This is simply a single-point switch that may be used by the motorman to cut the trolley

current off from the controller wiring so that the controllers will be absolutely dead. When two such switches are used, one on each end of the car, they are connected in series.

Car Circuit Breaker. Frequently on large equipments an automatic circuit breaker is provided instead of the overhead switch. This circuit breaker can be "tripped" by hand to open the circuit whenever desired. It is equipped with a solenoid magnet, which can be adjusted so that it will trip or open the circuit breaker at approximately whatever current it is set for. This circuit breaker protects

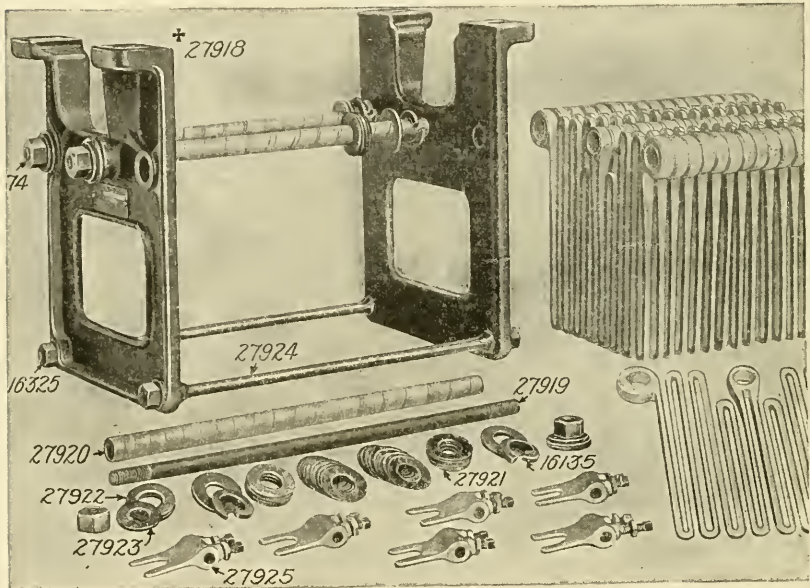

Fig. 122. Rheostat with Grids and Other Parts Displayed

the motor and car wiring from excessive current, such as would occur in case of a short-circuit in motors or car wiring, or in case the motorman turned on current so rapidly as to endanger the windings of the motors. Circuit breakers, however, are most commonly used on cars having controllers located at only one end in a motorman's cab. A typical automatic circuit breaker is illustrated in Fig. 124.

Fuses. A fuse is placed in series with the motor circuit between the trolley and the controller wiring. When circuit breakers are used instead of canopy switches, the fuse-box may sometimes be dispensed

with. The fuse-box on street cars is usually located underneath one side of the car body where it is accessible for replacing fuses, but when a motorman's cab is used, the fuse may be placed in the cab.

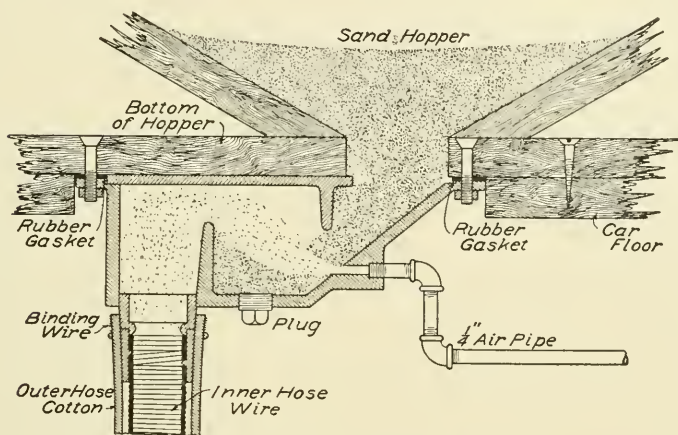

Fig. 123. Section of Pneumatic Sander

The fuse may be of any of the types in common use, either open or enclosed.

Lightning arresters are used on all cars taking current from

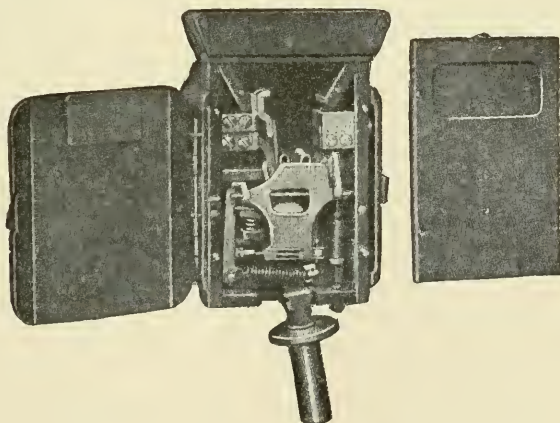

Fig. 124. Typical Automatic Circuit Breaker

overhead lines. The lightning arrester is connected to the main circuit as it comes from the trolley base, before it reaches any of the other electrical devices on the car, so that it may afford them pro-

tection. One terminal of the lightning arrester is connected to the motor frame so as to ground it, and the other is connected with the trolley. In most forms of lightning arrester, a small air gap is provided, not such as to permit the 500-volt current to jump across, but across which the lightning will jump on account of its high potential. To prevent an arc being established across the air gap by the power-house current after the lightning discharge has taken place and started the arc, some means of extinguishing the arc is provided. In the General Electric Company's lightning arrester, the arc is extinguished by a magnetic blow-out, which is energized by the current that flows through the lightning arrester. The instant the discharge takes place the current flows across the air gap. The magnetic blow-out extinguishes the arc, and this opens the circuit, leaving the arrester ready for another discharge. In the Garton-Daniels lightning arrester, shown in Fig. 125, a plunger contact operated by a solenoid opens the circuit as soon as current begins to flow through the arrester. This plunger operates in a magnetic field, which extinguishes the arc.

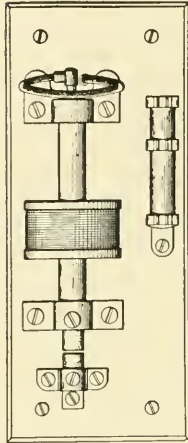

Fig. 125. Typical Form of Lightning Arrester

A choke coil, consisting of a few turns of wire around a wooden drum, is placed in the circuit leading to the motors as a point just after it has passed the lightning-arrester tap. This choke coil is

for the purpose of placing self-induction in the circuit, so that the lightning will tend to branch off through the lightning arrester and to ground, rather than to seek a path through the motor insulation

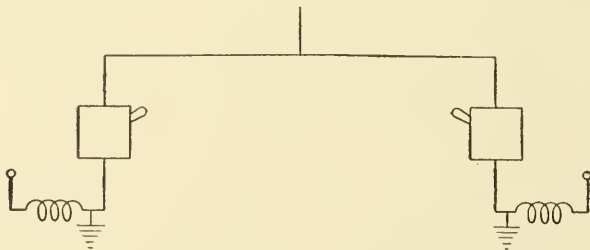

Fig. 126. Parallel Connections for Choke Coils and Circuit Breakers

for the purpose of placing self-induction in the circuit, so that the lightning will tend to branch off through the lightning arrester and to ground, rather than to seek a path through the motor insulation

to ground. Often, however, the choke coil is omitted, the coils in the circuit breaker and the blow-out coil in the controller being depended upon to prevent the lightning charge from passing.

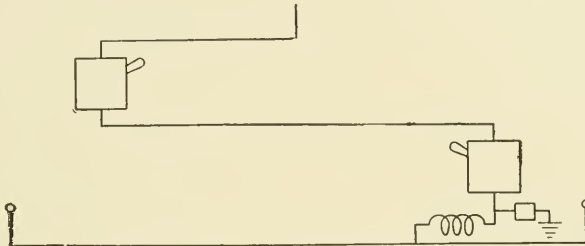

Fig. 127. Diagram of Series Connections for Hand-Operated Circuit Breakers

Wiring of Circuit Breakers and Canopy Switches. Figs. 126, 127, and 128 show the methods of wiring circuit breakers and canopy switches for double-end cars.

In the parallel connection as shown in Fig. 126, the trolley leads after passing through the choke coils go directly to the blow-out coil of the controllers. Aside from the fact that two lightning arresters and choke coils are required, this method is preferable for automatic circuit breakers.

Fig. 127 shows the hand-operated circuit breakers connected in series. This method is used where non-automatic breakers are employed, but for automatic breakers it has the objection that an overload would throw the breaker set at the lowest point. This

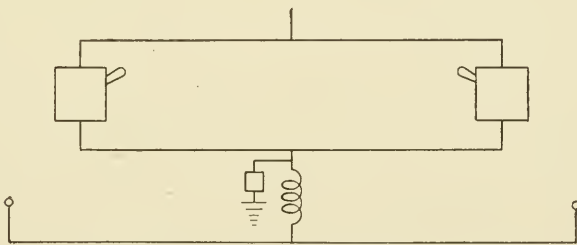

Fig. 128. Parallel Connections of Circuit Breakers Requiring but One Lightning Arrester

breaker might be at the opposite end, in which case the motorman must go to the other end of the car to set the breaker.

Fig. 128 shows a method of parallel connection requiring but one lightning arrester. This method, however, gives the motorman no

assurance that by throwing the breaker over him the power would be cut off, for the rear breaker may have been left set.

MECHANICS OF CAR MOVEMENT

A car has to be (a) brought up to speed, or *accelerated*; (b) maintained at speed; and (c) brought to rest, or retarded, or *decelerated*. In addition it may be allowed to *coast* or run without power.

There are several resistances which must be overcome in the above operations, viz, (a) friction* (including resistance due to curves); (b) grade resistance; and (c) resistance to acceleration.

The *friction* requires a tractive effort which increases somewhat with the speed. An average value for electric cars is about 20 pounds per ton (2,000 pounds). Where great accuracy is desired in this item it is necessary to use a formula which has been derived from experiment. Such a formula is the following, due to W. N. Smith.

$$R = 3 + 0.167V + 0.0025 \frac{A}{T} V^2$$

where R is the resistance in pounds per ton; V is the speed in miles per hour; A is the vertical cross-sectional area of the car in square feet plus one-half the vertical area from car floor to rails; and T is the weight of the car in tons of 2,000 pounds each.

ILLUSTRATIVE PROBLEM

(a) What tractive effort will be required to maintain a uniform speed of 35 miles per hour on a level track with a 20-ton car? The area of cross-section is 100 square feet.

Applying the Smith formula we have

$$R = 3 + (0.167 \times 35) + (0.0025 \frac{100}{20} \times 35^2) = 24.15 \text{ pounds per ton}$$

Total tractive effort $24.15 \times 20 = 483.0$ pounds

(b) What mechanical power is developed at this speed?

The power is the number of foot pounds per minute divided by 33,000 (the number of foot pounds per minute in one horse-power).

$$\text{h.p.} = \frac{483.0 \times 35 \times 5280}{33000 \times 60} = 45.1$$

*The frictional resistance opposing the motion of the car is made up of several components: flange, a gearing and bearing friction, and air resistance. The last increases rapidly with the speed while the others are nearly independent of it. Both of these differ from sliding friction, such as that between brake shoes and wheels, which decreases as the speed increases.

Curve Resistance. Curve resistance may sometimes be of importance. The usual method of allowing for it is to consider that there is a certain amount of resistance per ton per degree of curvature, say 0.7 pound. The number of degrees of curvature is the angle between two radii of the curve drawn at the ends of a chord 100 feet in length. In terms of the radius r , the angle of curvature is twice the angle of which the sine is

$\frac{50}{r}$. This relation is shown diagrammatically in Fig. 129.

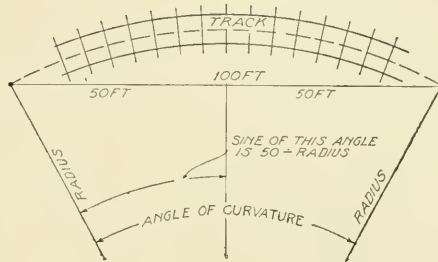

Fig. 129. Graphical Determination of Track Curvature

ILLUSTRATIVE PROBLEM

(a) What is the curvature of a curve the radius of which is 100 feet? As explained above, sine of $\frac{1}{2}$ the angle = $\frac{50}{100} = \frac{1}{2}$. From the table of sines we find that this is the sine of 30° . The angle of curvature is, therefore, 60° .

(b) What additional resistance is caused by this curvature?

$$R = 0.7 \times 60 = 42 \text{ pounds per ton}$$

Grade Resistance. Grade resistance, as was illustrated in connection with the series motor problems, is simply the tractive effort in the direction of car motion necessary to overcome the effect of gravity. It is numerically equal to the product of the weight of car, in pounds, and the grade, in per cent, divided by 100.

ILLUSTRATIVE PROBLEM

What tractive effort is necessary to overcome grade resistance on a grade of 10 per cent with the 20-ton car used in previous problems?

$$R = 20 \times 2000 \times \frac{10}{100} = 4,000 \text{ pounds, or } 200 \text{ pounds per ton}$$

Acceleration Resistance. A body resists any change in speed on account of the property of inertia. Thus, if at rest, it tends to

remain so; if moving with a given velocity, its tendency is to maintain this velocity. By definition, *force is the cause of acceleration of a mass*. The unit of force is that which will produce unit rate of acceleration (in other words, unit rate of increase in speed) in a unit of mass. But what is a unit of mass? This is a matter which has to be arbitrarily chosen by the government. The unit so chosen is the avoirdupois pound. The corresponding value of the unit of force will depend upon the kinds of units in which the acceleration is expressed. It is customary in this country to express acceleration in feet per second per second. That is, if the velocity of a body increases one foot per second every second, it may be said to have unit acceleration. A force which produces this acceleration in a mass of 1 pound is sometimes called a *poundal*. The poundal, while a good scientific unit of force, is not in common use. We are in the habit of speaking of force in pounds, using the word "pound" here to mean the force with which the earth attracts a mass of 1 pound. This force is not proportional to the mass, for it is different in different places. It is greater at the north pole than at the equator for the radius of the earth is shorter at the former. A pound of mass would weigh very little on the moon if the weight were determined by a spring balance calibrated or graduated on the earth, etc.

It is found by experiment that the earth, in most inhabited parts, exerts such a force on a pound of mass as to impart to it an acceleration of about 32.2 feet per second per second. If, therefore, we wish to use the expression "pounds of force," meaning by a *pound of force* the force exerted by the earth on a pound of mass, at a given point on the earth's surface, we must remember that this is equal, in poundals, to the acceleration due to gravity at that point. For practical purposes we can assume that a "pound" of force is about 32.2 poundals. It is in this sense that we have used the horizontal effort of a motor up to this point.

ILLUSTRATIVE PROBLEM

A street car weighs 40,000 pounds. It is desired that it reach a speed of 20 miles per hour in 20 seconds. How much force must be applied (a) in poundals, (b) in pounds?

Apply the formula

$$F = M \times a$$

where mass M is in pounds; and acceleration a is in feet per second per second.

$$F = 40000 \times \frac{20}{20} \times \frac{5280}{3600} = 58600 \text{ poundals}$$

The corresponding force in pounds in most parts of the earth's surface is

$$F = \frac{58600}{32.2} = 1820 \text{ pounds}$$

In railway work it is usual to use as a practical unit of acceleration a mile per hour per second. In the above problem the acceleration was one m. p. h. p. s. (abbreviation of miles per hour per second). The student must be careful to reduce the acceleration to feet per second per second in using the number 32.2, because this is the acceleration due to gravity in feet per second per second.

Braking. In bringing a car to rest the same principles apply as in acceleration. For example, suppose that we wish to bring the above car to rest from 20 m. p. h. in 20 seconds. What "tractive effort" must be exerted by the brakes? The tractive effort in this case is the tangential frictional force on the brake-shoes if we assume that the wheels do not slip on the rails. Applying the same formula as above, remembering that the force is now in a direction opposed to that of the motion of the car, we have, as before,

$$F = 58,600 \text{ poundals, or } 1,820 \text{ pounds}$$

This force does not have to be all supplied by the brakes, for the friction of the bearings, etc., assists the brakes in bringing the car to rest. If we assume, for convenience, that the friction is 20 pounds per ton, a total of 400 pounds, the net force which must be applied by the brakes is $1,820 - 400 = 1,420$ pounds.

Before leaving this part of the subject, attention is called once more to the fact that the decelerating force as calculated above is "gross". To it must be added any resistance which has to be overcome.

As a further example of the last statement, determine what total force is available to bring the car to rest going up a 5 per cent grade, with the same force as above applied by the brake-shoes.

Grade resistance is	$40000 \times 0.05 = 2,000$	pounds
Friction resistance is	$20 \times 20 = 400$	pounds
Deceleration resistance is	$= 1,420$	pounds
The total force available, therefore, is	$\frac{3,820}{\text{pounds}}$	

What net braking force is needed on this grade to bring the car to rest in 20 seconds?

We have seen that the gross decelerating force needed is 1,820 pounds. But the grade gives us 2,000 pounds, and the friction 400 pounds, a total of 2,400 pounds, when but 1,820 are needed. Evidently the car will come to rest in less than 20 seconds. A natural question is, "How long will it require to bring the car to rest without application of the brakes?" Applying the original formula, we note that the rate of deceleration corresponding to 2,400 pounds retarding force is

$$a = \frac{2400 \times 32.2}{40000} \times \frac{3600}{5280} = 1.32 \text{ m. p. h. p. s.}$$

At this rate the car would lose a speed of 20 m. p. h. in $t = \frac{20}{1.32} = 15.2$ seconds.

In the calculations a uniform deceleration is assumed for simplicity of calculation and no great error is involved in so doing. It is interesting, however, to note the actual values obtained from test. Fig. 130 shows the results of such tests. The curves illustrate the important fact that the speed falls off more slowly at the high speed, due to the lower coefficient of friction. With air brakes it is possible to so graduate the air pressure as to produce a practically uniform deceleration if there is any particular reason for having this. The curves show clearly the duration and the distance of braking in each case. The very quick stops, or emergency stops, show what can be done if necessary, although such stops are uncomfortable for the passengers and racking to the equipment. The rate of braking in these cases averages 3.3 m. p. h. p. s., while that for the slower stops is 2.3 m. p. h. p. s. The gross braking forces are, respectively, 120 and 84 pounds per ton.

Coasting. Whenever a motorman finds that he can make satisfactory speed without power, he cuts the latter off and "coasts" or "drifts." The car loses speed by the process and this loss of speed can be calculated by means of the acceleration formula. For example,

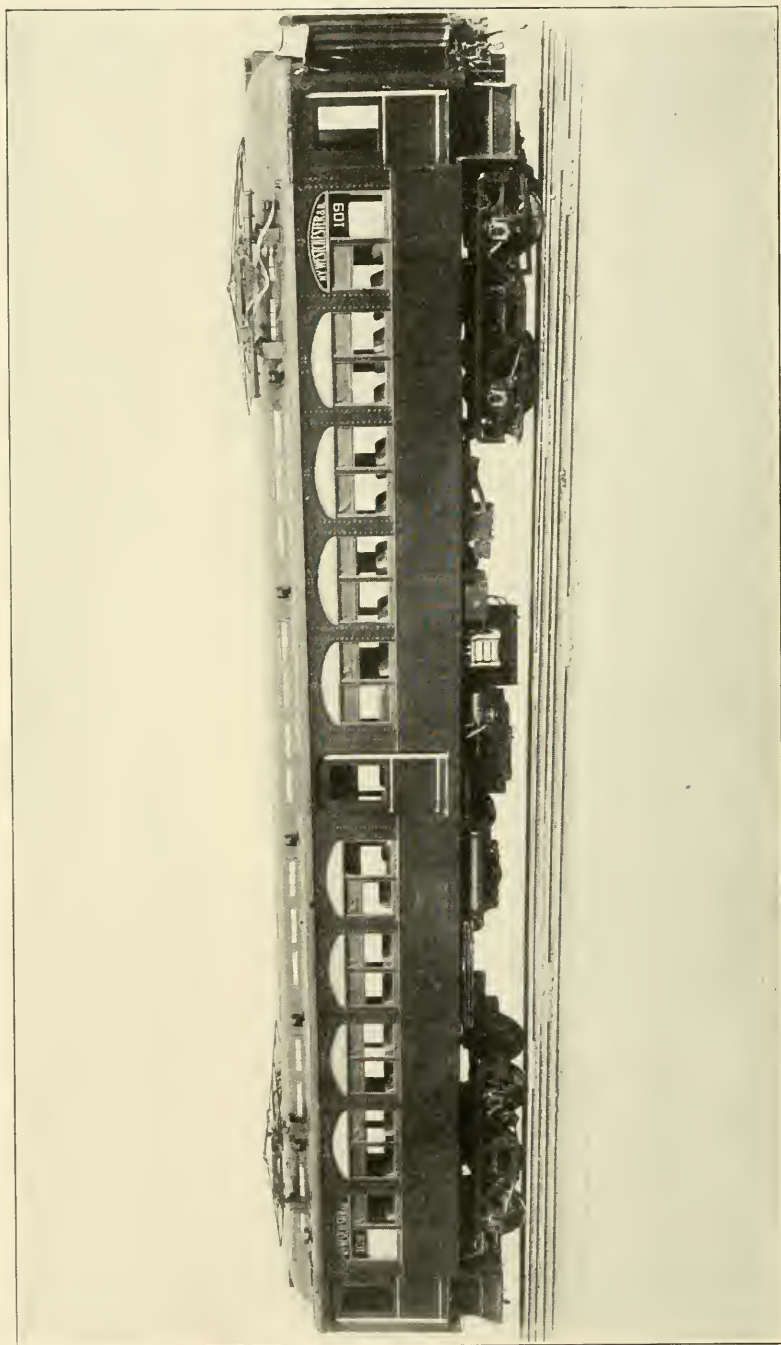

ELECTRIC MOTOR PASSENGER CAR USED ON NEW YORK, WESTCHESTER, AND BOSTON RAILROAD,
EQUIPPED WITH WESTINGHOUSE MOTORS AND CONTROL APPARATUS

Courtesy of Westinghouse Electric & Manufacturing Company

if the car is on level, tangent track, the decelerating force is simply the friction. This we have assumed to be 20 pounds per ton. If this be assumed constant, the total decelerating force is 400 pounds, from which the rate of deceleration is calculated as 0.22 m. p. h. p. s. The car will lose 1 m. p. h. of speed every 4.54 seconds.

Applications of the Principles of Mechanics to Series Motors Mounted on Cars. In practice it is impossible to secure uniform acceleration in a car because the counter electromotive force of the motors increases with the speed and cuts down the current. If the current could be kept uniform it would be possible to apply a constant *gross* accelerating force. Even then the *net* accelerating force would not be constant because the frictional resistance increases with the speed. For the present we shall neglect the latter item, however, as it is not of very great importance except in high-speed cars.

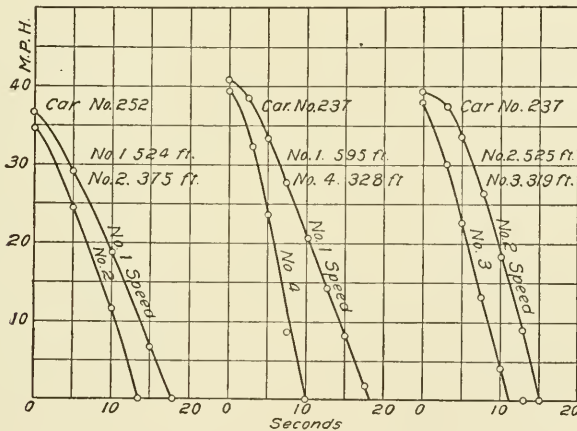

Fig. 130. Acceleration Curves

The problem is now to determine a curve between time and speed for a given equipment by combining the principles already carefully studied separately.

Acceleration Curves. Referring now to the curves of the motor, Fig. 47, we note that for every current there is a corresponding tractive effort with the given gear ratio and diameter of wheels. The motorman controls the amount of the starting current by the speed at which he "notches" out the starting resistance. In the automatic multiple-unit control systems this is done by the throttle

relay automatically. A good motorman should be able to cut out the resistance on his car at such a rate as to maintain the current *per motor* at a fairly uniform value. Of course, in the parallel position the car draws approximately twice the current that it does in the series position. Some cars do not draw uniform current even with the best of care on the part of the motorman. This is due to the incorrect arrangement of the resistances on the various notches, which should be corrected to insure the best results.

After the motorman has cut out all of the resistance he has no further control of the acceleration and the current falls off as the

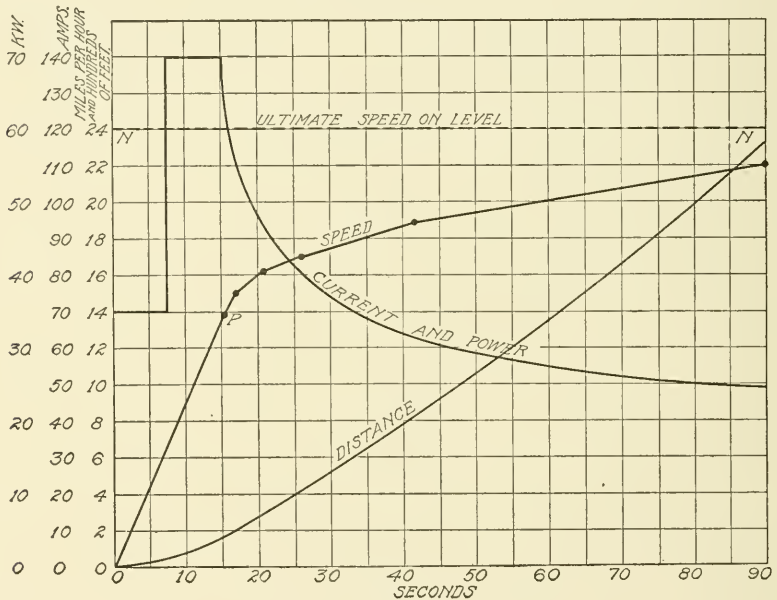

Fig. 131. Speed Curves

counter e. m. f. of the motor rises with increase of speed. Our problem is to determine the rate of acceleration at various parts of the speed curve and from this to determine the speed at the various points.

In Fig. 131 is shown such a curve. It is divided into two parts: (1) where the speed increases uniformly with time (constant acceleration); (2) where the speed increases more slowly due to the decrease in current (decreasing acceleration).

Assume that the starting current allowed is 70 amperes per motor. From the motor curves we find that this corresponds to a tractive effort of 1,030 pounds. If we put two of these motors on our 20-ton car the total tractive effort for the two motors is 2,060 pounds. Assume that the resistance due to friction is 20 pounds per ton and that the car is on level tangent track. No allowance need then be made for curve or grade resistance.

Applying the acceleration formula just explained, after deducting for friction, we find that the acceleration is 0.91 m. p. h. p. s. That is the speed will, for example, increase by 9.1 m. p. h. in ten seconds. A straight line can be drawn through the zero point and the speed at ten seconds and this gives the slope of the first part of the curve.

We must next determine how long this acceleration can be kept up. When the motorman has cut out all of the resistance, the speed must correspond to the current as given by the current-speed curve. This is not true while the resistance is in series with the motor for the resistance cuts down the natural speed for a given current. We, therefore, read on the curve the speed corresponding to the assumed starting current and stop the straight speed-line at this point. In the assumed case this is 14.0 m. p. h. and uniform acceleration has continued for 15.4 seconds.

Next we must determine point-by-point the shape of the speed curve beginning at the point just determined as a starting point. This must be done graphically. Assume an increase of speed to a value slightly above the first speed, say 15.0 m. p. h. During the brief time in which the speed has been increasing the average speed was

$$\text{average m. p. h.} = \frac{14+15}{2} = 14.5 \text{ m. p. h.}$$

Looking now on the motor curves we find that the current corresponding to this average speed is 60 amperes and the tractive effort is 840 pounds per motor. The corresponding acceleration is 0.70 m. p. h. p. s. Beginning with the point p , we lay off a straight line at such an angle as to correspond to the calculated acceleration. We assume here that the acceleration will remain uniform during this short period. Continuing in this way step-by-step, we finally have an approximate form of the speed curve. With a "French curve"

these points can be connected by a smooth line. For the most accurate work the points should be chosen very close together in the part of the curve where it is bending rapidly.

The dotted line NN , is the ultimate speed of the car after all of the acceleration is over. This is determined by assuming that all of the tractive effort is used up in friction resistance, the speed being then read directly from the curves. In this case it is 24 m. p. h.

Distance Curve. The speed curve leads directly to the distance curve, for, as distance is the product of speed and time, the distance up to any time is the area under the speed curve up to that time. In other words, it is the product of the time and the average speed. The area can be determined in various ways, for example by counting the squares under the curve when it is plotted on cross-section paper.

Current Curve. Up to the point where resistance is all cut out the current has the assumed value per motor. In practice it is not uniform but follows a zigzag line while the controller handle jumps from notch to notch. Its average value is, however, that from which we calculated the acceleration. At any other time the current is obtained from the current-speed curve of the motor direct and it has been plotted for the assumed case in the figure.

Power Curve. As the e. m. f. is constant it is possible to obtain the power at any time by multiplying together the current and the e. m. f. This gives the power in watts from which the kilowatts or electrical horse-power can be derived by multiplying by the proper constants.

Data from Road Tests. Fig. 132 gives in graphical form the results of a test of the equipment of an interurban car, made in regular service. It is especially valuable in permitting a comparison of the forms of the curves as calculated and as obtained under service conditions. The upper line shows the line volts, which are the same as the motor volts when the motors are in parallel without starting resistance. The motor volt line indicates how the e. m. f. across the motor terminals increases as the starting resistance is cut out. The motor amperes line, on the other hand, coincides with the car amperes line when the motors are in series, for in this case the same current flows through both motors. The speed line is wavy on account of the change in profile, but it is fairly constant after the period of acceleration is over. It will be noted that there is not the

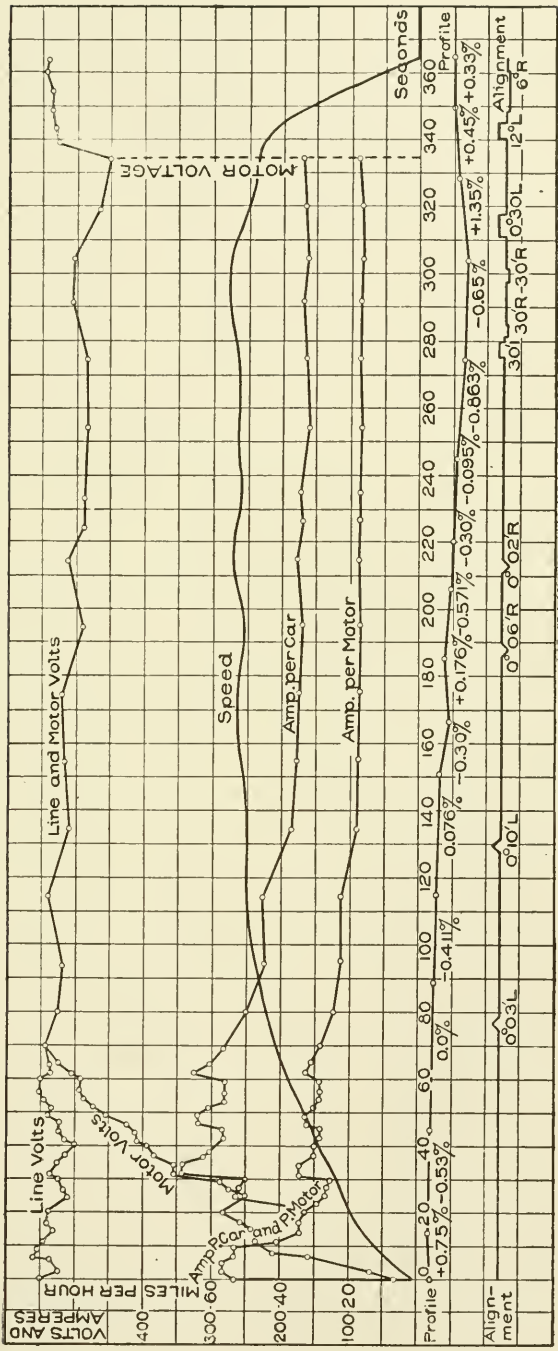

Fig. 132. Graphical Representation of Road Test Data

same form of acceleration curve as we obtained by calculation, but a glance at the "current per motor" line will show why. The current per motor was not kept constant by the proper manipulation of the controller. The lower lines show the profile and alignment. The profile shows the grades upon which the car was operating at the times indicated by the base of the chart. The grades are marked in per cent, the sign "+" being used to designate an up-grade and the sign "-" a down-grade. The alignment shows when the curves are met, the degrees of curvature being indicated as well as the direction of curvature.

MAINTENANCE OF ROLLING STOCK

In order to insure the best service from the car equipment, it must receive careful inspection and repair. Oil requires replacing, brushes must be renewed, etc. Repairs of all kinds must be made promptly to prevent further injury to the equipment.

Oiling. Proper bearing lubrication is of prime importance because a dry bearing will not only ruin itself but it will cause waste of power. Good modern practice seems to favor oiling on a mileage basis, the number of miles between oilings depending upon the make of motors, as the later types have better accommodations for the oil. The armature bearing mileage will vary from 500 to 1,000 for the older motors and may be as high as 3,500 in the newer ones. The axle bearings will operate from 1,000 to 2,000 miles between oilings.

INSPECTION

It is not good practice to wait until a serious defect develops before making repairs to an equipment. Regular inspections will show incipient faults and render their repair easy and cheap. As an evidence of the importance of inspection work the following extract is made from the 1909 report of the Committee on Maintenance of Equipment to the American Electric Railway Engineering Association.

INSPECTION WORK

The slighting of inspection work will cause serious interruption to traffic. Worn and flat trolley wheels cause arcing that burns the overhead wire; dry trolley wheel bearings cause cutting and shorten the life of the wheel; a pole put in with the wheel set at an angle causes the trolley to jump at the switches and may pull the trolley base off the

car or pull the overhead wire down and, in addition to the damage caused, endanger life.

The improper fastening of poles in their bases may be the cause of accidents, and if the spring tension is weak it causes undue arcing and increases the wear on both wheel and wire. If a base is neglected and becomes dry, the trolley runs hard, causing jumping at switches and trouble without limit. Poor contact at the base causes the wire to burn off. Leaky roofs ruin car ceilings, are bad for seats and generally uncomfortable for passengers. Broken glass is a frequent cause of accidents. Bolts, nails and screws, if projecting from floor or any part of woodwork, sometimes result in torn clothes and falling passengers. Extended step-treads sometimes strike vehicles, resulting in splinters and sharp edges and their accompanying dangers.

If cars are allowed to go into service with dirt or grease somewhere on the inside, the company may have to pay a bill.

Controller rolls, contacts and bearings, if allowed to become dry, will cut and cause short-circuits; the roll will work hard and the motor-man may not be able to tell distinctly whether or not he is stopping on the points; contact fingers may be set too low, and sometimes the set-nut, if left loose on the adjusting screw, works out and the finger drops down and jams on the roll contact. Controller handles, if neglected, become worn and may not turn the roll to the last point, then running on the resistance, burning out a rheostat, and danger of fire may follow.

Neglect of the oiling of motor bearings and car journals is probably the most expensive of all slighted inspection, because it causes the bearings to heat and the armature to go down on the pole pieces.

Lack of care in inspecting motor terminals when connecting up may result in a broken wire in a short time.

Bolts left loose in the armature and axle caps; cotters left out of bolts and hinge pins; brush-holder hammers left up; carbons not cleaned and sticking in their holders; weak springs; failure to tighten bolts and screws at yokes; oil and dust accumulated on brush holders and yokes until they short-circuit and ground; neglect to oil and pack truck journals; brasses allowed to wear down, causing hot journals; bolts in the trucks, not kept tightened, wearing face and holes so that later they cannot be kept tight; all these are points that must be carefully watched to insure the best results.

Tight brakes frequently cause the loss of armatures, which may be blamed upon lubricating system. Improper adjustment and setting of shoes causes them to flange and to lose a large per cent of their life. Worn and neglected hangers cause brakes to shudder and chatter. Cotters left out of shoe-pins, and neglected lever-pins may cause serious damage and accident. Leaks in the air system not discovered result in overworking the compressor. Neglected brake valves cause the seats to cut. Cleaning and oiling, etc., brake cylinders, and a thousand and one other little jobs, should not be neglected. Such neglect is always serious, and may be dangerous. It has a direct bearing on expense. Quite a common practice among repair men is to patch up trouble and

fail to give the car and motors a careful inspection, so that further early trouble may be avoided. Lack of inspection is decidedly detrimental to best economy.

LOCATING DEFECTS IN MOTOR AND CONTROLLER WIRING

Defects in the wirings are due (1) to open-circuits, and (2) to short-circuits. Open-circuits make themselves evident by the failure of the current to flow when the circuit is closed. Short-circuits make themselves evident usually by blowing of a fuse or opening of the breaker. The point of the short-circuit or "ground" can be located roughly by noting on what controller point the fuse is blown. Accurate location can be made by cutting out the motors, disconnecting, etc., according to directions in the following pages. The tests outlined apply particularly to the **K** type of controller with two-motor equipment.

TESTS FOR OPEN-CIRCUITS

No current on first point—circuit is open but point cannot yet be located.

No current on first point multiple—motors are probably all right.

No current on series-resistance points after trying first point multiple—open-circuit is outside controller and equipment wiring.

With an open-circuit wiring anywhere between trolley and ground no current will flow on the first point. Open-circuits are most likely to occur in the motors and these may be tested first. However, as will be explained later, one open-circuit in an armature will not stop the current.

To test the motors open the breaker and put the controller on the first multiple point. Then flash the breaker quickly. A flow of current indicates that one or the other of the motors has an open-circuit. In the series position this open-circuit prevents the flow but in multiple current the current flows through the other motor. The one at fault can be quickly located by returning the controller to the off position and cutting out one or the other of the motors by means of the cut-out switch and then trying for current. The car can in any event be operated by means of the remaining motor. On returning to the shop the open-circuit can be determined definitely by the use of the lamp bank.

If no current flows when the breaker is flashed on the parallel point, it is reasonable to conclude that the motors are all right and

that the open-circuit is elsewhere. As there is a path through each motor normally, there would necessarily be an open-circuit in each one to stop the current. It is hardly probable that such a coincidence would occur.

After failure to find fault with the motors, the controller should be placed on progressive series-resistance points and the breaker flashed on each one. If current is obtained on any point, the open-circuit is in the resistance or the resistance lead just behind the one being used. Special care should be used to flash the breaker quickly, for otherwise the fuse may be blown.

The tests indicated are sufficient for the motors, controllers, and resistance wiring. If no current is obtained on either of them, the trouble is evidently caused by a poor rail contact, a ground wire off (if both motors are grounded through the same wire), or an open-circuit in the blow-out coil, at the lightning arrester, circuit breaker, or on top of the car.

None of the tests applied locate the open-circuit definitely, but this can easily be done in the shop or wherever a lamp bank is at hand. Connect one terminal of the lamp bank to the trolley just behind the circuit breaker and the controller on the series first point, then with the other terminal begin at the ground and trace backwards up the circuit until the lamps fail to light. The path in a **K** type of controller is readily traced with the help of the controller diagram, page 55, Part I.

TESTS FOR SHORT-CIRCUITS

The location of short-circuits is tedious. The blowing of the fuse or opening of the breaker will locate them as shown below. The separate tests can then be followed until the location is definite. These tests are especially adapted to cases on the road or where no facilities for testing are at hand. Rather than to blow fuses as frequently as indicated it would in most cases be better to place a lamp bank across the open-circuit breaker and note the flow of the current by the lights.

CASE I

Fuse blows when trolley is connected:

- (1) Grounded controller blow-out coil.
- (2) Grounded trolley wire or cable.
- (3) Grounded lightning arrester.

The blowing of the fuse immediately on closing the overhead switch or circuit breaker, when the controller is on the off position, indicates that the fault exists somewhere between the circuit breaker and the upper or trolley finger of the controller.

Should the defect occur during a thunderstorm, it may be presumed at once that lightning has grounded the blow-out coil of the controller.

CASE II

Fuse blows on first point:

- (1) Grounded resistance near *R1*.
- (2) Grounded controller cylinder.
- (3) Bridging between sections of cylinder.

When the controller is on the first point all of the wiring of the system with the exception of the ground wire for No. 1 motor is connected with trolley. But a defect in the wiring beyond the resistance will not show itself on the first point by an abnormal rush of current because the resistance of the rheostats is sufficient to prevent any excessive flow of current.

The resistance and leads and the controller cylinder are the only parts to be tested when the fuse blows on the first point.

CASE III

Fuse blows on third or fourth point:

- (1) Grounded resistance near *R4* or *R5*.
- (2) No. 1 motor grounded.

With either of the above defects the car will most probably refuse to move as the current is led to ground before passing through the motors.

No. 1 motor may be tested by cutting it out of service by means of its cut-out switch. If this removes the ground, the motor is at fault.

CASE IV

Fuse blows near last point multiple:

- (1) No. 2 motor grounded.
- (2) Either armature short-circuited.

The fact that the fuse did not blow on the series positions excludes the resistances and No. 1 motor from investigations for grounds. Cut out both motors. If the ground still exists the controller is defective. If not, the fault may be located in either one of the motors by cutting out first one and then the other.

MISCELLANEOUS TESTS

Armature Tests for Grounds. With a lamp bank at hand, tests for grounded armature can be made as follows:

Throw the reverse on center. Attach one terminal of the lamp bank to the trolley. Put the other terminal on the commutator of the armature to be tested. If there is no current, the armature is not grounded. If current flows, remove the brushes and try again, to be certain that the ground is not in the leads.

Field Tests for Grounds. Disconnect field leads and put the test point of the lamp bank on one side of the terminals. If no current flows the fields are not grounded.

Reversed Fields. In placing new fields in the shell it often happens that one or more are wrongly connected. Reversed fields make themselves known by excessive sparking at the brushes.

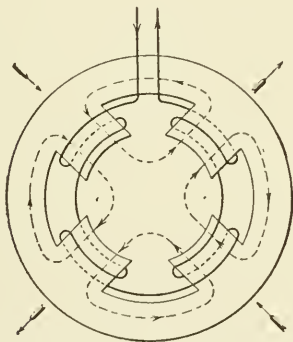

Fig. 133. Motor Field Coils Properly Wound

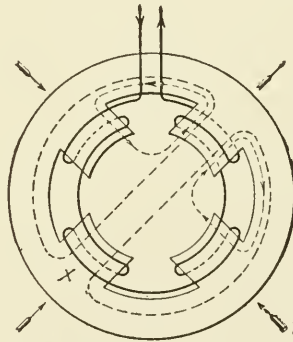

Fig. 134. Magnetic Field of Motor When One Field Coil is Reversed

In Fig. 133 all of the fields are connected correctly. The flow of magnetism is into one pole and out of the adjacent one. Some of the magnetism leaks out of the shell and affects a compass held near the outside. The direction taken by the compass needle in the different positions is shown. The needle should point in opposite directions over adjacent coils and should lie parallel to the shell in positions half way between two coils.

Figure 134 shows the flow of magnetism when one field is reversed. In such a case the compass will take the position shown. The field marked "X" is the one reversed.

With one reversed field a machine will usually operate, as the magnetism in three of the poles is in the normal direction. But an excessive flow of current that has no effect in turning the armature will take place on that side of the armature next to the reversed field.

Motor-Coil Testing. Testing for faults in the motor armature and field coils is done in a great variety of ways. The resistance of these coils can be measured by means of a Wheatstone bridge employing a telephone receiver in place of the galvanometer used in such bridges in laboratory practice; but other less delicate tests are also in use.

Another method is to pass a known current through the coil to be tested and to measure the drop in the voltage between the terminals of the coil. The quotient of the voltage and the current is the resistance.

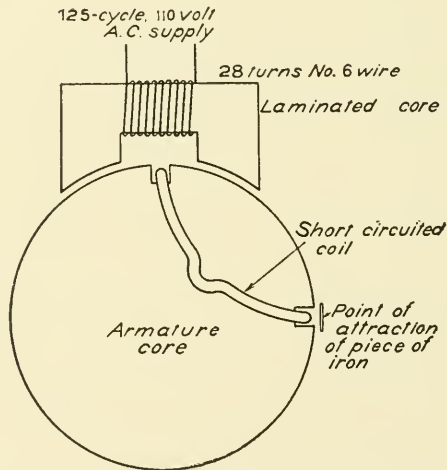

Fig. 135. Diagram Showing "Transformer Test"

A simple method, and one which involves no delicate instruments, is largely used in railway shop practice. This is known as the *transformer test* for short-circuited coils. It requires an alternating current which can easily be supplied either by a regular motor-generator or by putting collecting rings on an ordinary direct-current motor and connecting these rings to bars of opposite polarity on the commutator. This method is indicated in diagram in Fig. 135. A core, built up of soft laminated iron, is wound with, say

28 turns of No. 6 copper wire. This coil is supplied with alternating current from a 110-volt circuit. The core has pole pieces made to fit the surface of the armature. When one side of a short-circuited coil in the armature is brought between the pole pieces of this testing transformer, the short-circuited armature coil becomes the short-circuited secondary of a transformer, and a large current flows in it. This current will in time manifest itself by heating the coil; but it is not necessary to wait for this, as a piece of iron held over that side of the coil not enclosed between the pole pieces will be attracted to the face of the armature if held directly over the coil, but will be attracted at no other point. This testing can be done very rapidly, and does not require delicate instruments or skilled operators.

Tests for short-circuits in field coils can be made in a similar manner, by placing the coils on a core which is magnetized by alternating current. The presence of a short-circuit, even of one convolution of a field coil, will be apparent from the increase in the alternating current required to magnetize the core upon which the field coil is being tested.

The insulation resistance of armatures and fields is frequently tested by means of alternating current, about 2,000 volts being the common testing voltage for 500-volt motor coils. One terminal of the testing circuit is connected to the frame of the motor, and the other to its windings. Any weakness in the insulation insufficient to withstand 2,000 volts will, of course, be broken down by this test. Alternating current is generally used for such tests because it is usually more easily obtained at the proper voltage, as it is a simple matter to put in an alternating transformer which will give any desired voltage and which can be controlled by a primary circuit of low voltage.

Open circuits in the armature can be detected by placing the armature in a frame so that it can be rotated, the frame being provided with brushes resting 90 degrees apart on the commutator. If either an alternating or direct current be passed through the armature by means of these brushes, and the armature be rotated by hand, a flash will occur when the open-circuited coils pass under the brushes. A large current should be used.

Grounds. As one side of the circuit is grounded, any accidental leakage of current from the car wiring or the motors to ground

will cause a partial short-circuit. Such a ground on a motor will manifest itself by blowing the fuse or opening the circuit breaker whenever current is turned into the motor. In case the fuse blows when the trolley is placed on the wire and the controller is off, it is a sign that there is a ground somewhere in the car wiring outside of the motors. Moisture and the abrasion of wires are the most common causes of grounds in car wiring. In motors, defects are usually due to overheating and the charring of the insulation.

Burn-Outs. Burning out of motors is due to two general causes: *First*, a ground on the motor, which, by causing a partial short-circuit, causes an excessive current to flow; *second*, overloading the motor, which causes a gradual burning or carbonizing of the insulation until it finally breaks down.

Short-circuited field coils having a few of their turns short-circuited, if not promptly repaired, are likely to result in burned-out armatures, as the weakening of the field reduces the counter-electromotive force of the motor, so that an abnormally large current flows through the armatures. Cars with partially short-circuited fields are likely to run above their proper speed, though, if only one motor on a four-motor equipment has defective fields, the motor armature is likely to burn out before the defect is noticed from the increase in speed.

Defects in Armature Windings. Defects in armature windings cause a large part of the maintenance expense of electrical equipment of cars. Almost all repair shops have men continually employed in repairing them. The most frequent trouble with armatures is through failure of the insulation of the coils and consequent "grounding". This term is used in connection with armatures and fields and other electrical apparatus where a direct path exists to ground. As the armature core is electrically connected to the ground through its bearings and the motor casing, a break-down of the insulation of the coils in the slots permits the current to pass directly to ground. This shunts the current around the fields and an abnormal current flows because of their weakness. The circuit breaker or fuse is placed in circuit to protect the apparatus in such an emergency, but usually before such devices break the circuit, several of the coils of the armature are burned in such a manner as to make their removal necessary. The coils are so wound on top of one another that in

order to replace one coil alone, one-fourth of the coils of the armature must be lifted.

With the armature of No. 1 motor grounded the car will not operate and if the resistance points be passed over, the fuse will usually blow. When No. 2 motor is grounded the action of No. 1 motor is not impaired and this latter motor will pull the car until the controller is thrown to the multiple position. But if the motors are thrown in multiple, the path through the ground of No. 2 motor shunts motor No. 1.

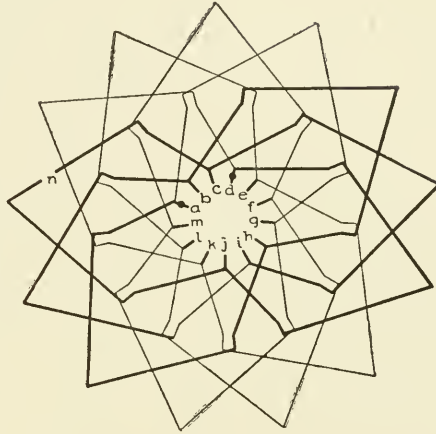

Fig. 136. Diagram Showing the Effect of an Open-Circuit in Armature Winding

Next to grounding, open-circuits are the most serious defects of armatures. These are usually caused by burning in two of the wires in the slot, or where they cross one another in passing to the commutator. Sometimes the connections where the leads are soldered to the commutator become loose.

The effect of an open-circuit is shown in Fig. 136. The circuit is open at *n*. The brushes are on segments *a* and *d*. By tracing out the winding it will be found that no current flows through the wires marked in heavy lines. Whenever segments *c* and *d* are under a brush, the coil with the open-circuit is bridged by the brush and current flows as in a normal armature. As segment *c* passes out

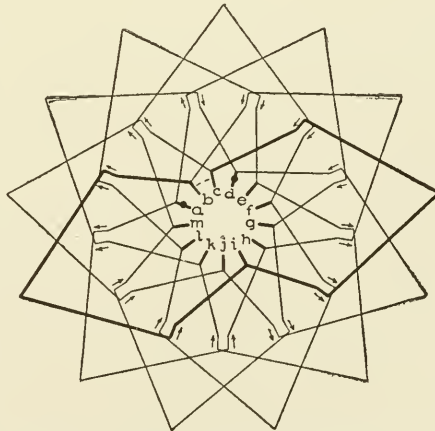

Fig. 137. Diagram Showing the Effect of Short-Circuit Between Two Coils

from under the brush, the open-circuit interrupts the current in half the armature and a long flaming arc is drawn out.

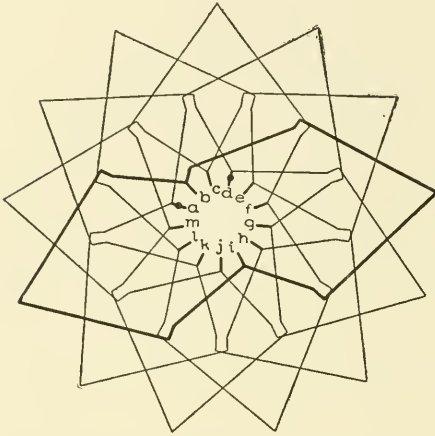

Fig. 138. Diagram Showing the Effect of Crossed Leads

to their proper commutator segments sometimes so confuse him that misconnections are made. The effect of getting two leads crossed is shown in Fig. 138. The leads to segments *b* and *c* from the right are shown inter-

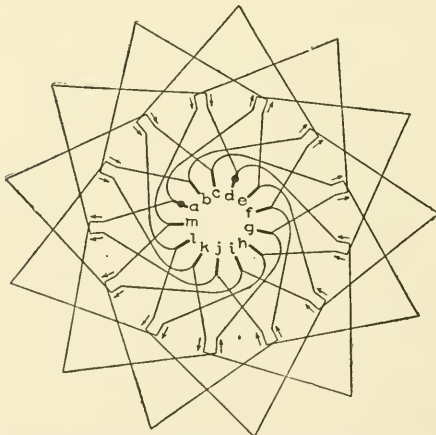

Fig. 139. Diagram Showing the Effect of Wrong Connections to Commutator Bars

of *cn* segment *b* as is the case in Fig. 137. The only result of such

In Fig. 137 is shown the result of a short-circuit between two coils. The short-circuit is at *bc*, the two leads coming in contact with each other when they cross. The effect is to short-circuit all of the winding indicated by the heavy lines.

Mistakes in Winding Armatures. The armature winder is given very simple rules as to winding the armature, but the great number of leads to be connected sometimes so confuse him that misconnections are made. The effect of getting two leads crossed is shown in Fig. 138. The leads to segments *b* and *c* from the right are shown interchanged. This short-circuits the coils shown in heavy lines. The abnormal current resulting in these would usually cause them to burn out.

Fig. 139 shows the result of placing all of the top leads or all of the bottom leads one segment beyond the proper position. This causes the circuit starting from *a* and traveling counter clockwise around the armature to return on segment *m* instead

connections is to change the direction of rotation of the armature. It may be noticed by comparing the two figures that with the positive brush on segments *a*, the arrows show the currents to be in opposite directions in coils similarly located with reference to the position of the brushes. Some armatures are intended to be wound as in the last case mentioned.

Sparking at the Commutator. As railway motors are made to operate, and usually do operate, almost sparklessly, sparking at the brushes may be taken as a sign that something is radically wrong.

The pressure exerted by the spring in the brush holder may not hold the brush firmly against the commutator.

If brushes are burned or broken so that they do not make good contact on the commutator, they should be renewed or should be sandpapered to fit the commutator.

A dirty commutator will cause sparking.

A commutator having uneven surface will cause sparking, and should be polished off or turned down.

Sometimes the mica segments between commutator bars do not wear as fast as the bars and when this is the case, the brushes will be kept from making good contact when the commutator bars are slightly worn. The remedy is to take the armature into the

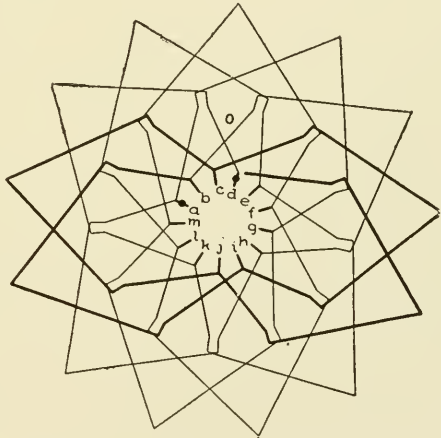

Fig. 140. Diagram Showing the Effect of Open-Circuited Coil Causing Sparking at the Commutator

shop, and groove out the mica between the commutator bars for a depth of about $\frac{1}{4}$ inch below the commutator surface. This grooving is found to be very beneficial also as a general practice. It greatly improves the whole operation of the commutator and brushes.

A greenish flash which appears to run around the commutator, accompanied by scoring or burning of the commutator at two points, indicates that there is an open-circuited coil at the points at which the scoring occurs, as in Fig. 140.

The magnetic field may be weakened by a short-circuit in the field coils, as before explained, and this may give rise to sparking.

Short-circuits in the armature may give rise to sparking, but will also be made evident by the jerking motion of the car and the blowing out of the fuse.

Failure of Car to Start. The failure of the car to start when the controller is turned on may be due to any of the following causes:

Opening of the circuit breaker at the power house.

Poor contact between the wheels and the rails owing to dirt or to a breaking of the bond wire connections between the rail on which the car is standing and the adjacent track.

One controller may be defective in that one of the contact fingers may not make connection with the drum. In this case try the other controller if there is another one on the car.

The fuse may be blown or the circuit breaker opened. The occurrence of either of these, however, is usually accompanied by a report which leaves little doubt as to the cause of the interruption in current.

The lamp circuit is always at hand for testing the presence of current on the trolley wire or third rail. If the lamps light when the lamp circuit is turned on, it is a tolerably sure sign that any defect is somewhere in the controllers, motors, or fuse boxes, although in case the cars are on a very dirty rail enough current might leak through the dirt to light the lamps, but not sufficient to operate the cars. In such a case, the lamps will immediately go out as soon as the controller is turned on. Ice on the trolley wire or third rail will have the same effect as dirt on the tracks.

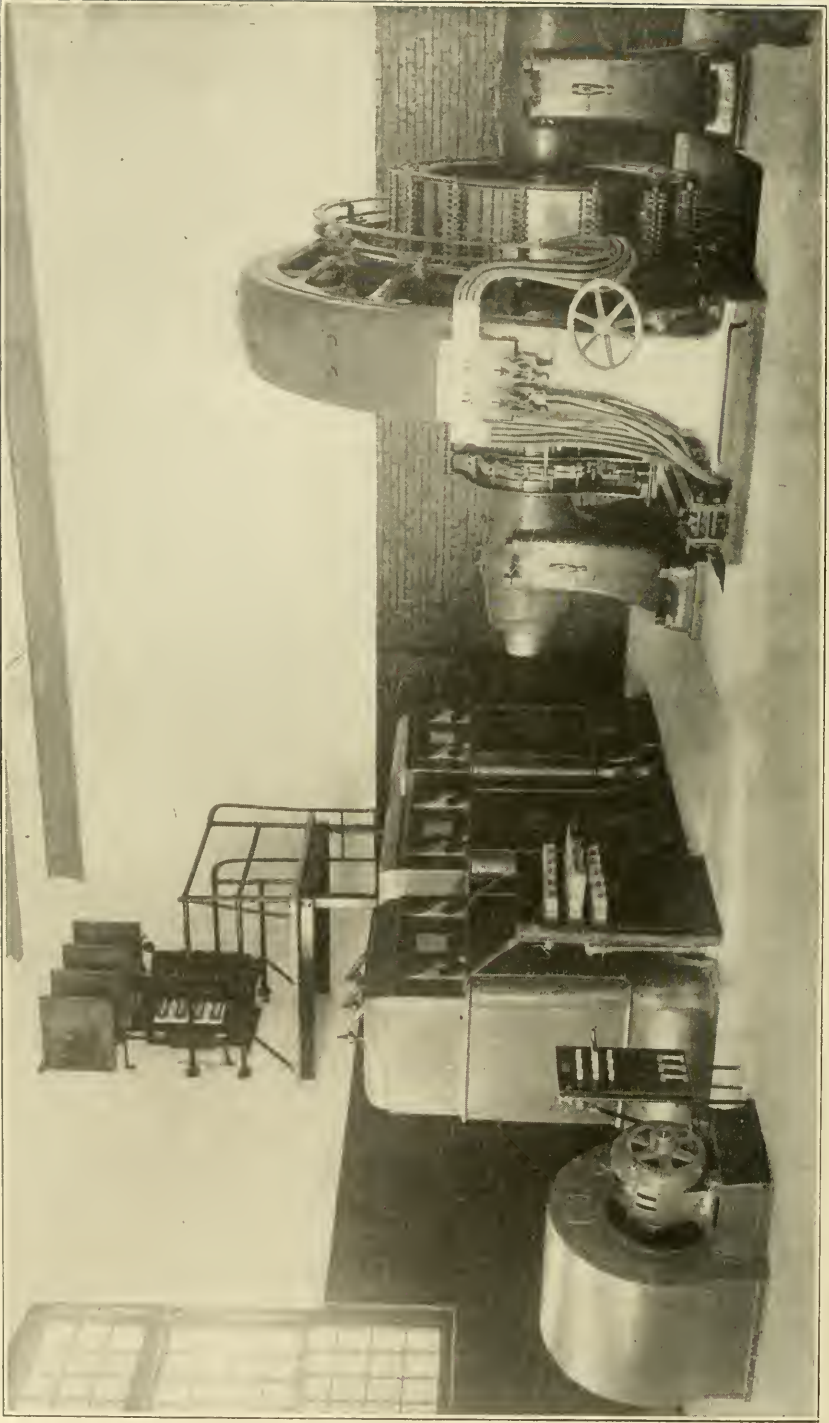

INTERIOR OF SUB-STATION SHOWING ROTARY CONVERTER AND TRANSFORMERS.

The three-phase current is delivered to the transformers where it is stepped down to the voltage required for the rotary converter. In this machine it is transformed to direct current and delivered to the trolley wire.

ELECTRIC RAILWAYS

PART III

POWER PLANTS

From his study of electric generators earlier in the course the student is familiar with the general principles of the electrical machinery of power stations, and of switchboards, and of electrical auxiliaries. With this foundation it will be easy to study the characteristic features of railway power stations. These stations owe their characteristic features to the following facts:

(1) The load is of a fluctuating character.

(2) As a rule, the power must be generated in a form suitable for transmission to fairly long distances because a railway usually covers a large territory.

(3) The power supply must be very reliable.

The railway load is of a fluctuating character, *first*, because each car takes current irregularly; and *second*, because the number of cars operated at one time is quite variable.

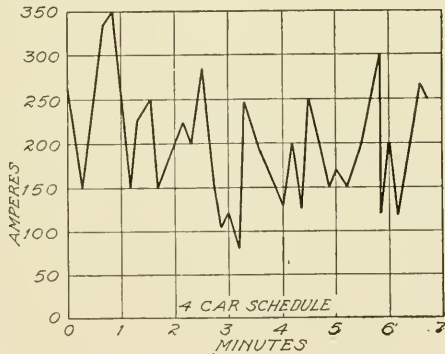

Fig. 141. Load Diagram for Small System

The momentary fluctuations are especially notable in a road having but few cars. Here the starting or stopping of each car results in a peak or a depression in the load curve of considerable magnitude in proportion to the average load. Fig. 141 is a load diagram from such a road.

In large roads the momentary fluctuations do not amount to much because each car draws a smaller proportional amount of power and the starting currents are not so noticeable. In this case, however, the fluctuations during the whole day are greater

because the number of cars in operation varies more than in the small road which is apt to have a rather uniform schedule. In the

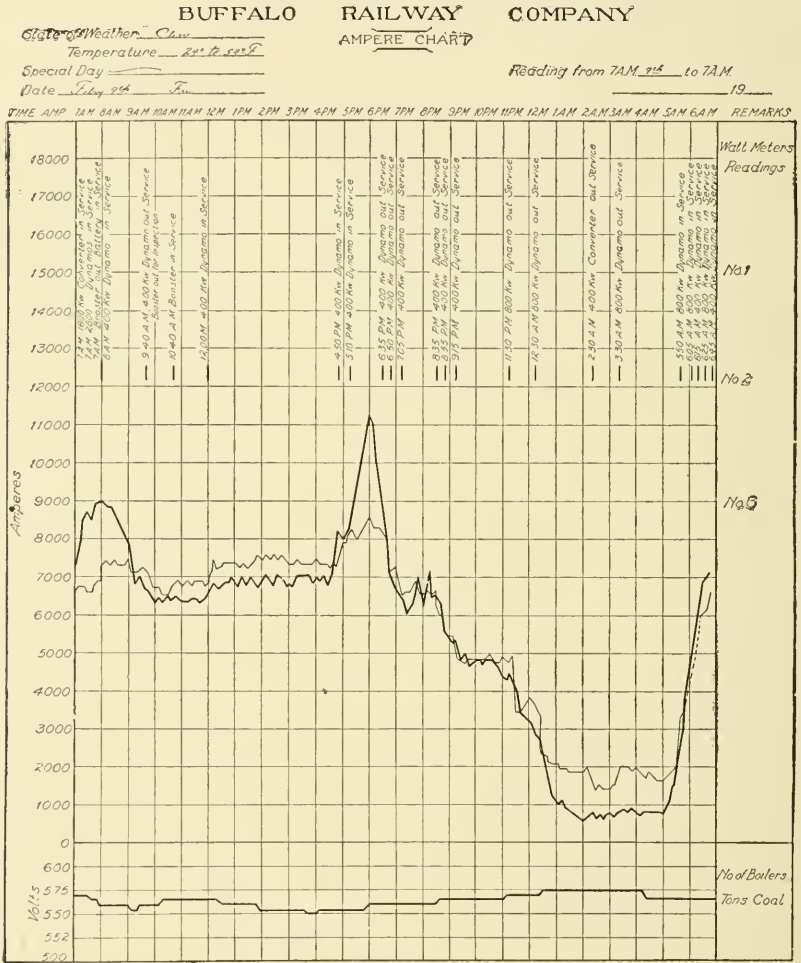

Fig. 142. Load Diagram for Large System

large road it would not pay to run the same number of cars at 10 A. M. as at 6 P. M. for most of them would be empty. A typical diagram for a large system is given in Fig. 142, in which the heavy line is the amperes to line, the light line the amperes from generators. The difference is due to the storage battery; when the heavy line is above, the battery is discharging, and *vice versa*.

As a power house is an electrical energy factory, it is subject to the same economic laws as any other factory. Its function is to produce reliable electrical energy at a minimum total cost per kw. hour. To operate economically requires that boilers, engines, generators, etc., be allowed to furnish an output as near their full-load capacity as possible in order that the efficiency may be high. In studying the lay-out of a few typical stations the above points should be kept in mind to see how the requirements are met in practice.

CHARACTERISTIC FEATURES

POWER HOUSE CONSTRUCTION AND ARRANGEMENT

In a power plant the principal raw materials are fuel, air, and water. It is a good plan to follow the routes of these through the plant in regular order and thus eliminate the danger of overlooking any important feature.

Coal Circuit. The coal circuit begins with the coal pocket or storage. This coal is conveyed in one way or another to the boiler room. It is fed to the boilers either automatically or by hand. The ashes leave the grates and are handled either automatically, semi-automatically, or by hand, and finally they are delivered outside the building.

The air for the combustion of the fuel is drawn in from the boiler room or it is supplied by fans under pressure. It passes through the fire bed and is sucked away from the fire by the chimney or stack or by suction fans. On the way to the chimney it may pass through an economizer and give up some of its heat to the feed water which circulates through the economizer in pipes.

Feed Water. The feed water comes in the first place from the source of water supply. It passes through pumps in most plants, although injectors may be used if the water is not too hot. In general the feed water is heated by passing it through atmospheric heaters into which the steam discharges from the non-condensing engines and pumps. This heater can be arranged as a purifier also if the water is allowed to flow slowly over pans. Scale precipitates under the action of heat in this way and it is prevented from forming in the boiler. Another plan for preventing the formation of boiler scale from the feed water is to add chemicals which will prevent the precipitation of the scale under the action of heat.

In very large plants a heater is sometimes used in the exhaust steam circuit from engine to condenser as explained below, but in general this is an unnecessary refinement. In some plants the feed water then goes through the economizer where it is heated to a high temperature, say 212° F., by the flue gases. It then flows into the boiler.

Steam Circuit. The steam circuit begins at the boiler where steam is generated in a "saturated" condition. It may be superheated either by tubes above the water line in the boiler or by a separately-fired superheater. After flowing through the risers, headers, and leads, it passes to the engines—through steam separators if there is any danger of condensation in the piping. It is practically necessary that the engines get dry steam. From the engines the steam goes to the condenser or to the atmosphere, the latter being an extremely

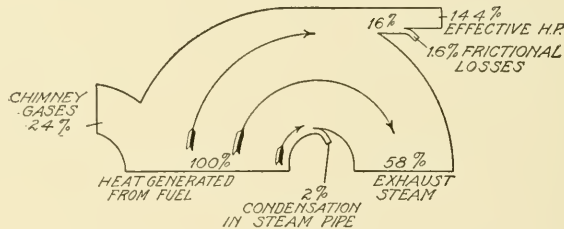

Fig. 143. Diagram Showing Heat and Other Losses in Power Plant

wasteful process. The condensing chamber is kept cool by the circulation of cool water through pipes so that the steam is immediately condensed. In some plants there is a vacuum feed-water heater between the engine and the condenser. Such a heater relieves the condenser by partly performing its function. It also heats the feed water slightly and thus helps the atmospheric heater. The condensed water then goes to the hot well for use in the boilers again. If jet condensers are used the condensed steam and condensing water are mixed and there is but a small proportion of the water used again. Jet condensers, while simple in construction, can only be used where the water is reasonably pure.

Circulating Water. The circulating water for the condensers comes from a stream or from a reservoir in connection with a cooling tower. It is pumped through the condenser either by a pump or by its own weight (as in the barometric type). After this it flows

out again, being either wasted or returned to the cooling tower to give up its acquired heat. If jet condensers are used the water is partly returned to the hot-well for boiler feed and partly returned to the source of supply, as above.

Power Circuit. The power circuit begins at the engine where mechanical power is transferred to electrical power. From the generator the power flows through the electrical circuit to the switch-

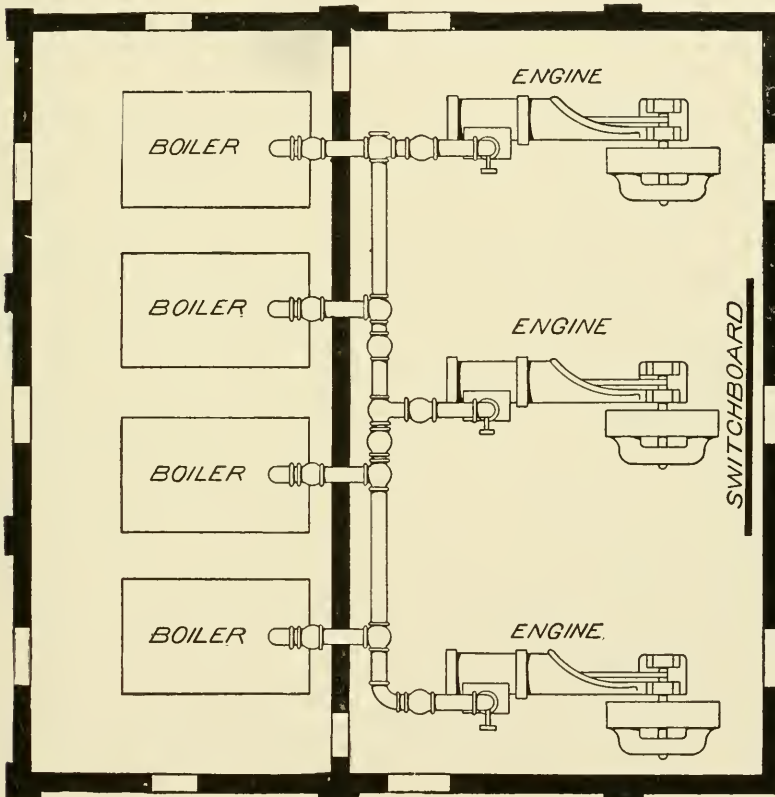

Fig. 144. Diagram of the Principal Elements in a Small Power Station

board, thence to the transformers, if any are used, and it finally reaches the outside circuit. Before doing so it may be converted from one form to another as, for example, from 3-phase alternating current to direct current, for railway purposes.

HEAT AND OTHER ENERGY TRANSFORMATIONS

Transformation of energy in the power plant is extremely inefficient even with the best management. Fig. 143 shows the large losses involved in a typical case. Starting with 100 per cent of energy in the coal pile, 24 per cent is lost in the boiler room through the flue gases, ashes, unburned fuel, radiation, etc. Of the 76 per cent which starts for the engine, 2 per cent is lost in condensation. In the engine the loss is greater yet, as the steam, in expansion, gives up but 16 per cent of the original energy. Finally in the transformation from mechanical to electrical form, a small amount is lost and this loss is augmented by the transmission line loss.

Simple Steam Station. The elements of a small station are shown in Fig. 144. The building is rectangular in form, divided by a fireproof partition between boiler room and engine room. The boilers would, in general, be of the water-tube type, and of a rating from 250 to 500 h.p. each. A boiler horse-power is the ability to generate 30 pounds of steam per hour at 70 pounds pressure with a feed-water temperature of 70° F. The boilers are connected through risers and valves to a steam header from which steam is taken for the engines.

The engines in this plant are high-speed or "automatic" engines direct connected to 500-volt, compound-wound, direct-current generators. A switchboard, containing the switches (generator and feeder), the circuit breakers, and the measuring instruments, is placed at a central point.

The engines are operated condensing if there is convenient condensing water, on account of the steam economy resulting from the use of condensers.

Small Reciprocating Engine Plant. The power house of the Winona Railway Company is shown in elevation and plan in Figs. 145 and 146. It is similar in general plan to the station already described but contains much more detail. Starting at the left of Fig. 145, we note that coal is received on an overhead track just outside the boiler-room wall. It falls into the coal shed from which it is fed to the boilers by hand. The ashes are removed by hand.

In the boiler room are four water-tube boilers furnishing steam at 150 pounds pressure. Water is furnished to the boilers by steam feed pumps, being drawn from the discharge of the jet condensers.

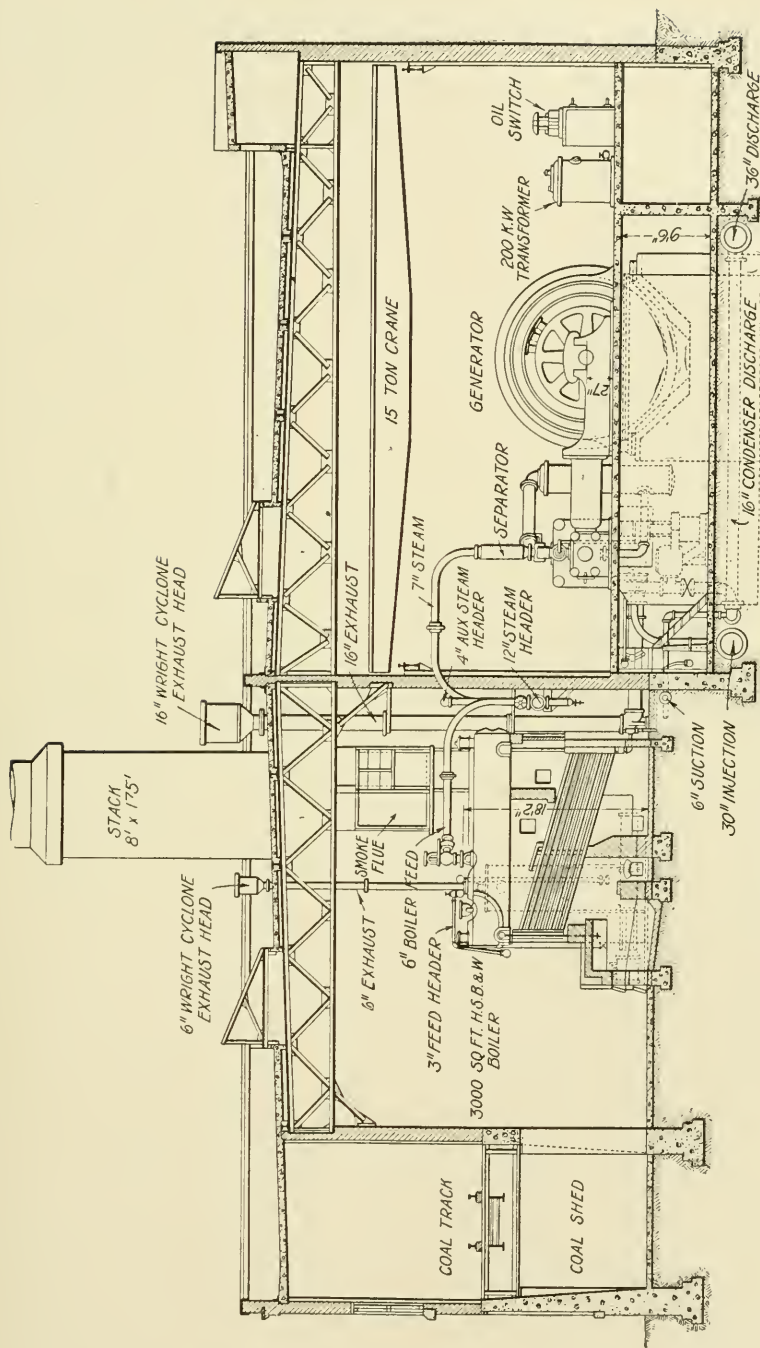

Fig. 145. Elevation of Winona Railway Company Power House

The feed water is heated in the *atmospheric heater* which receives the exhaust steam from the feed pumps. The atmospheric heater is so-called because it operates at atmospheric pressure.

The steam is drawn from the boiler into a 12-inch header which is located below the level of the boiler outlets. This header accumulates any moisture which may be formed in the pipes. The arched

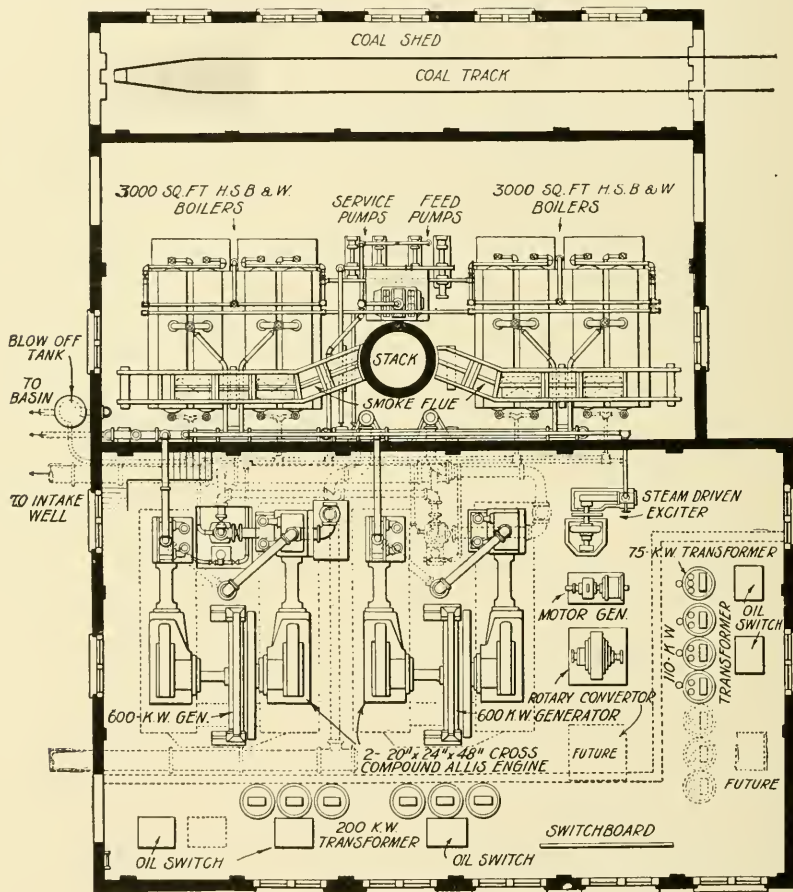

Fig. 146. Plan of Winona Railway Company Power House

engine leads are tapped into the top of the header and, therefore, draw the dry steam from it. Each lead has, however, a steam separator to dry the steam just as it enters the engine.

The 850-h.p. engines are of the Corliss, slow-speed type, cross-

compound, with a 3-phase, 2,300-volt, 25-cycle alternator of 600-kw. capacity direct connected between the high-pressure and low-pressure section of each. Between the high- and low-pressure cylinders is a large vertical receiver from which the low-pressure cylinder draws its supply of steam. The low-pressure cylinder exhausts into the jet condenser located just beneath it.

The alternators are excited by a steam-driven and a motor-driven exciter, the former for starting up and the latter for continuous use, the motor-driven exciter being more efficient than the other.

For transmission the e. m. f. is raised from 2,300 volts to 33,000 volts by means of two banks of three transformers, each with oil-switch control. Alternating current is used in this station as in a large proportion of the railway plants, because it can be transmitted efficiently. This must be converted into direct current for local railway distribution necessitating the use of the rotary converter. This is located in the power-house engine-room together with transformers for lowering the e. m. f. to about 375 volts. It appears, at first sight, uneconomical to go through this round-about process when the direct current could be generated directly. By experience it has been found best, however, to generate a standard form of current and to provide substations for conversion to direct current even under the same roof. One 300-kw. converter with all necessary auxiliary apparatus is installed at present, but provision has been made for extension as shown by the dotted rectangle.

The switchboard in this plant is placed where it is readily accessible. It contains the measuring instruments and switches for controlling the output of the station.

Railway Plant in Modernizing Process. An excellent idea of the tendencies in railway power-plant development is given by the plant illustrated in Fig. 147. This was at one time a reciprocating engine station but during the past few years some of the older engines have been discarded and steam turbines substituted.

In the boiler room are two batteries of boilers, one consisting of four 400-h.p. Stirling, the other of four 600-h.p. Babcock and Wilcox boilers. The boilers are hand-fired from the wide firing aisle shown next to the engine-room wall. Coal is distributed along this aisle in a pile against the wall by means of an electric hoist which travels on an overhead rail. The boilers are provided with a forced draft

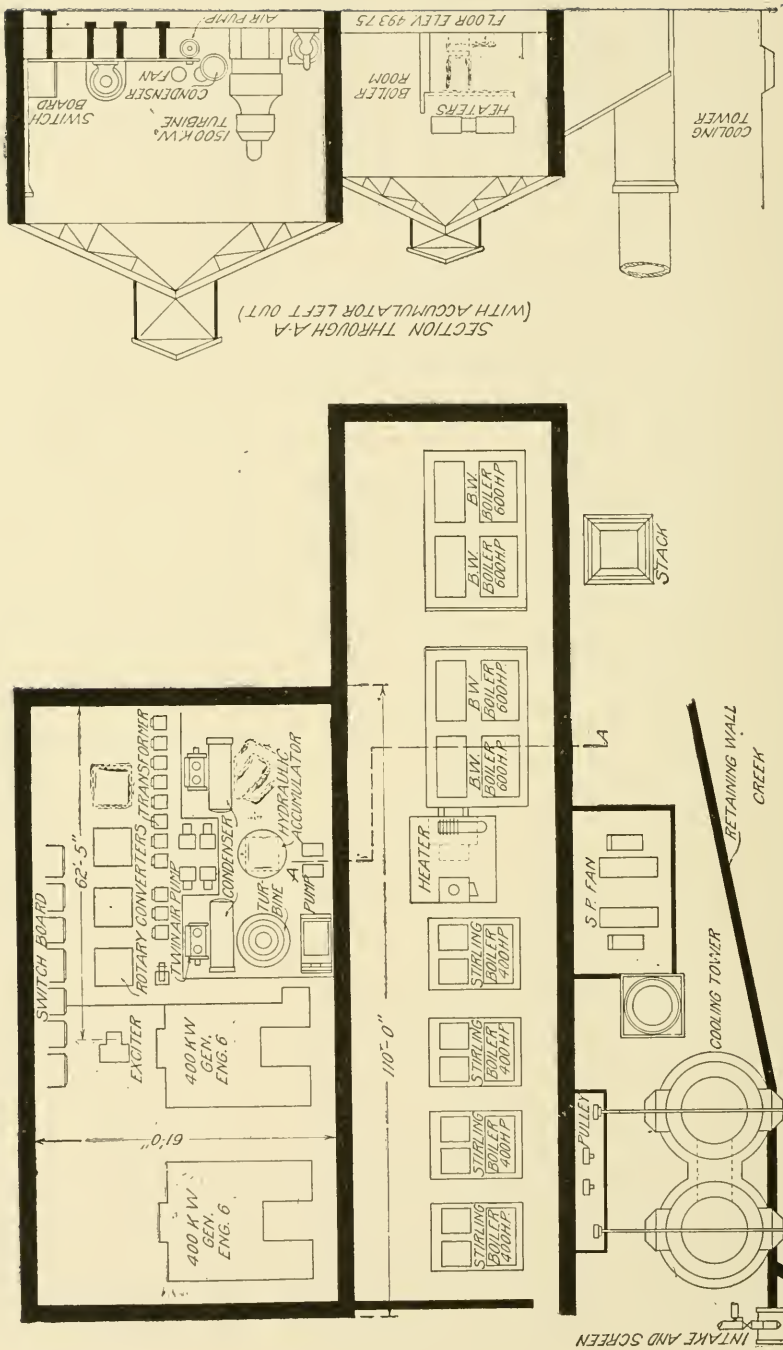

Fig. 147. Plan and Elevation of Modernized Railway Plant, Showing Use of Steam Turbines, Modern Boilers, etc.

by means of engine-driven fans which drive the air through large ducts located under the boiler-room floor. Dampers in the individual boiler ducts permit the adjustment of the draft. The exhaust gases are taken off by two brick stacks, 150 feet in height. Feed water for the boilers is delivered to them from the condensers by feed pumps. The feed water is heated by passing it through heaters into which flows the exhaust steam from the pumps and other auxiliaries which are run non-condensing.

In the engine room are two distinct types of engine. There are two 400-kw. direct-connected sets consisting of three-phase, 2,300-volt, 60-cycle, revolving-field alternators, and cross-connected compound Corliss engines. The latter exhaust into jet condensers. The remaining two engines are vertical Curtis turbines exhausting into surface condensers. The condensers have air pumps to remove air from the condensing chamber and circulating pumps to force the condensing water through the tubes. The condensing water is cooled in two cooling towers through which air is forced by motor-driven fans. This is necessary because there is not sufficient cool water from the neighboring creek to supply the large amount of water necessary. This amount can be roughly estimated from the capacity of the station and an assumed range of temperature of the cooling water. Let us estimate that 30 pounds of water will be required per pound of steam. If the engines were all fully loaded they would be developing 4,800 h. p., which would, at 16 pounds of steam per h.p. hour, require 76,800 pounds of live steam per hour. The corresponding circulating water would be 2,304,000 pounds per hour. This would require a stream of fair size. In connection with the cooling tower there is, in this plant, a large reservoir from which water for the condensers is drawn.

Steam is taken from the boilers to the engines through a 10-inch header which is connected at middle and ends to a similar header in the engine room, making a cross-connected steam loop. In this way the steam has three possible routes. Alternating-current generators are used in this station, as in the plant previously described, on account of the greater ease and efficiency of transmission of alternating current over wide areas. As before, a substation is also located under the power-house roof to convert the current to the direct form in rotary converters for local use.

St. Clair Tunnel Power Plant. A plant of moderate size with rather unusual provision for efficient operation with intermittent load is that of the Grand Trunk Railroad located at Port Huron, Michigan. Unusual care was put into the design of this station because the operating conditions are so severe. Heavy trains have to be hauled through the tunnel under the St. Clair River at irregular intervals separated by periods of no load. The intervals are of a duration too short to permit of the charging and discharging of a storage battery. For simplicity, alternating-current locomotives were selected and the power is, therefore, generated in the form in which it is used. In Figs. 148 and 149 are shown details of this plant.

Handling Fuel. Coal is received on a special track which permits cars to be run right over the hoppers into which they dump the coal. As the St. Clair River is close by, the coal could be transferred readily from barges were it found desirable. However, as the railroad owns the power plant, coal can be delivered cheaply by rail.

From the hoppers the coal falls into a crusher which reduces the size of the lumps to that suitable for use under the boilers. After being crushed it is raised on a bucket elevator to the top of the building where it is received on a horizontal belt conveyor which distributes it along the coal bunkers in the boiler room. From the bunkers the coal falls by gravity through iron chutes to the hoppers of the under-feed stokers by which it is forced under the boilers.

The ashes are drawn by hand from under the grates onto iron gratings which cover the ash hoppers. The clinkers are broken up and the ashes fall into the hoppers and into small hand cars. By means of these they are dumped into an ash chute connected with the coal elevator, which can be used to raise them to a small storage bunker. From the ash bunker the ashes are delivered by gravity to cars outside the building.

Forced Draft. Air for the boiler plant is supplied by forced draft from two engine-driven fans, the speed of which is controlled by an automatic regulator controlled by the boiler pressure. When the latter falls, the fan-engine throttle-valve is opened and the speed of the engines is increased, thus supplying more air to the boilers. At the same time it is necessary that more coal be fed to the grates.

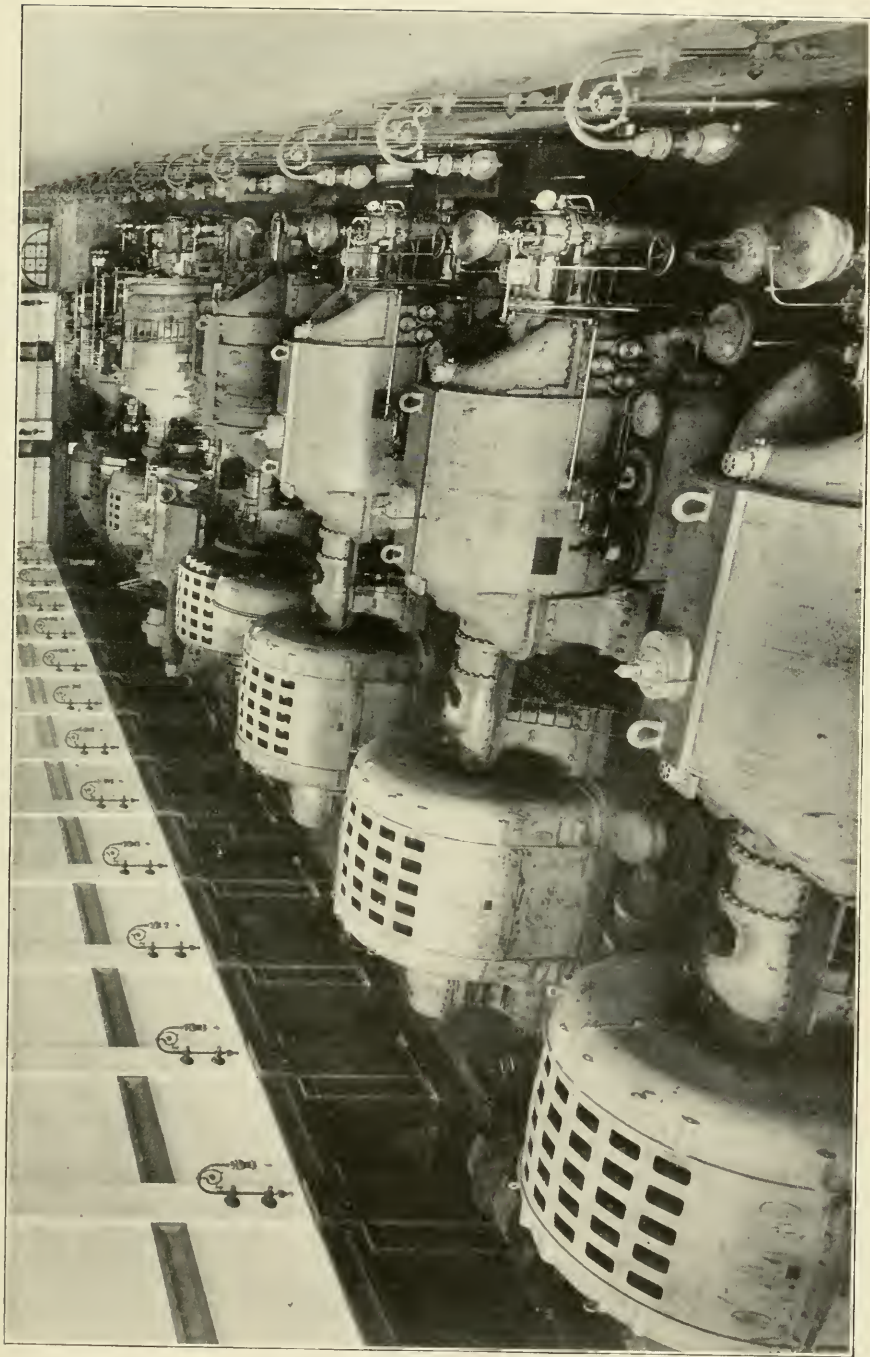

WESTINGHOUSE TUBRO-GENERATOR INSTALLATION OF THE BROOKLYN RAPID TRANSIT COMPANY.
RATED CAPACITY OF PLANT 100,000 KILOWATTS

Courtesy of Westinghouse Machine Company

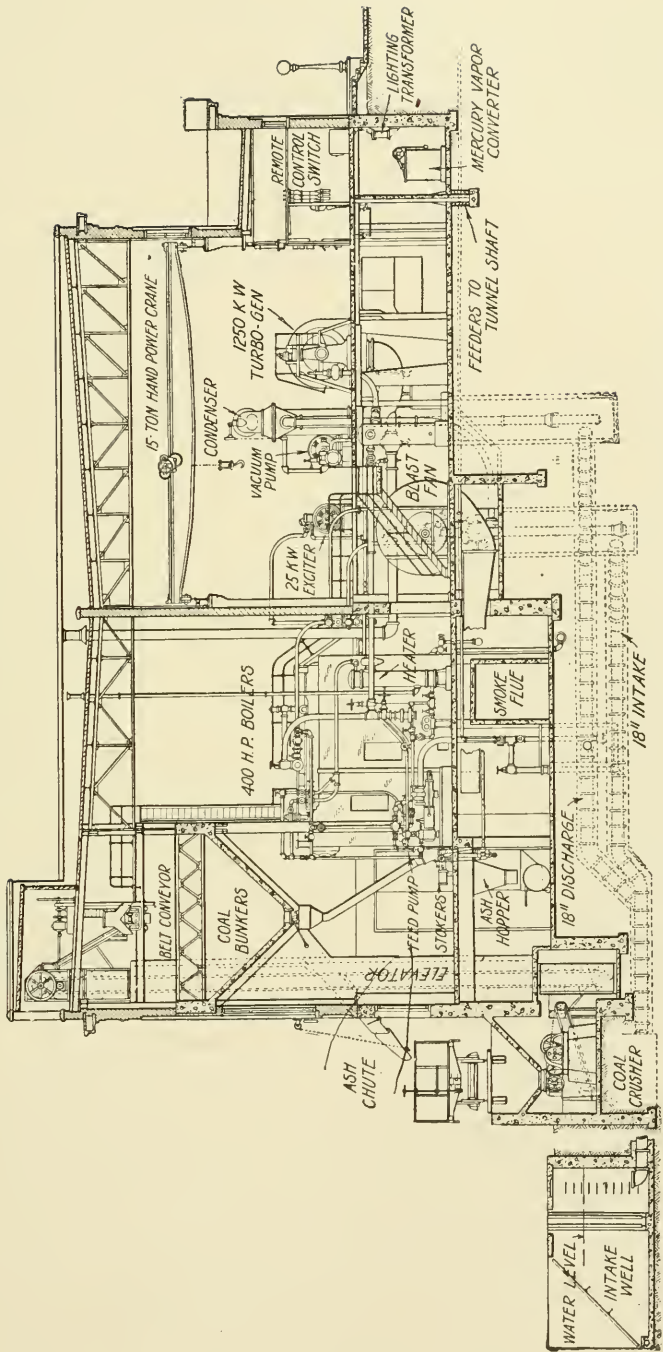

Fig. 148. Sectional Elevation of St. Clair Tunnel Power Plant of the Grand Trunk Railroad

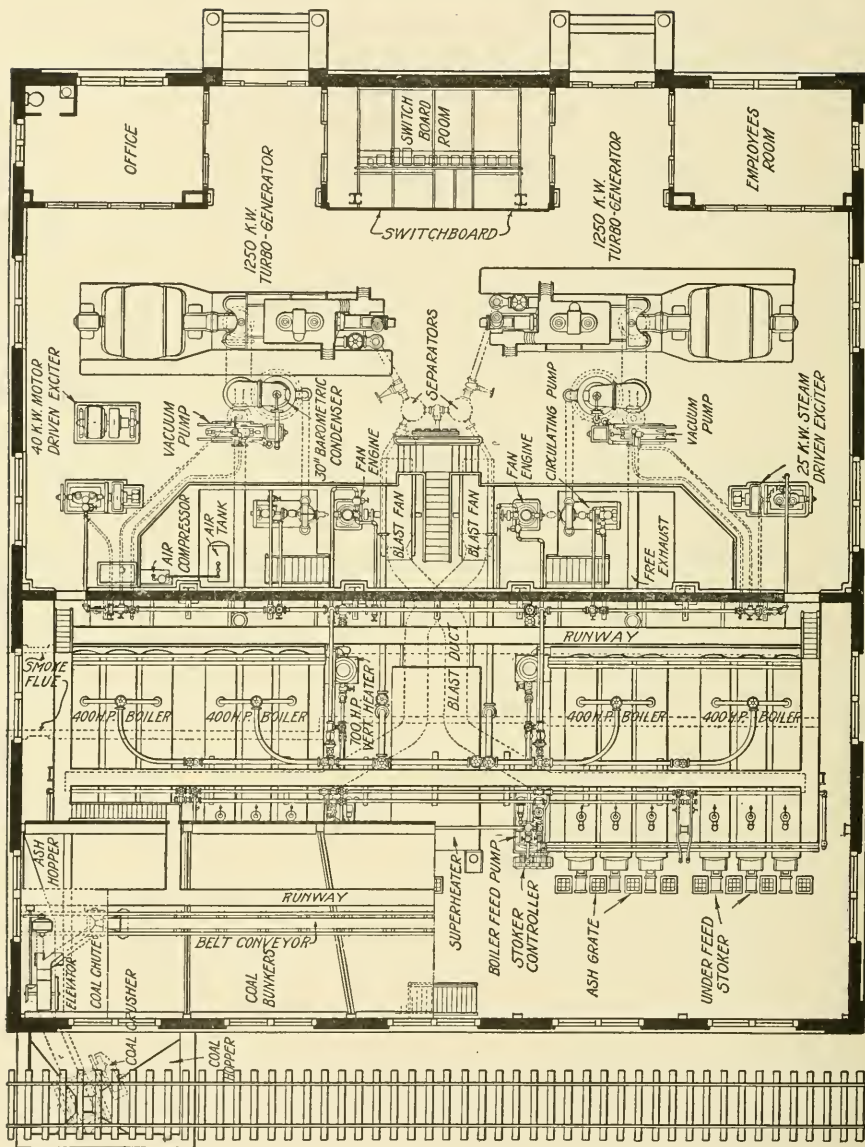

Fig. 149. Plan of St. Clair Tunnel Power Plant of the Grand Trunk Railroad

This is accomplished by means of a stoker regulator which is belted to the fan engines. Whenever the fan engines increase their speed, the stoker regulator does the same. In this way the boilers automatically take care of an increase in the load, for this causes a falling off in boiler pressure which in turn increases the quantity of steam produced by the boilers. The plant operates with a very slight change in boiler pressure.

Superheated Steam. The steam produced by the boilers is superheated in a separate superheater. The function of this device is to raise the temperature of the steam about 200° F. above the natural temperature at a pressure of 200 pounds per square inch. As it is impracticable to control the firing of the superheater by the method used in the boilers, the following plan is employed: A temperature regulator controls the flow of air into the combustion chamber of the superheater; when the temperature is high, the air is admitted above the grate and the fire is cooled; when the temperature is low, the air is admitted under the grate, thus increasing the intensity of the fire.

Feed Water. The feed water for the plant comes primarily from the city water service, this water being the purest available. Ordinarily it is only necessary to draw from this source enough to make up for the leakage, as the condensed steam from the engines is nearly enough. In case it is necessary, however, water can be drawn from the St. Clair River, which is the source of the condensing water. The feed water in general is pumped from the hot-well by duplex feed-pumps through an oil separator which takes out any oil brought over from the engines. The water then passes through the feed-water heater into the boilers.

Turbines and Generators. The live steam flows from the boilers to two horizontal steam turbines direct connected to three-phase, 3,300-volt, 25-cycle generators. From the engines the steam goes to barometric jet condensers, supplied with circulating and air pumps, and finally in the form of condensed steam, the water reaches the hot-well again, thus completing the water-steam-water circuit.

The electric generators are three phase although the plant is single phase. Three-phase generators were used, presumably, because they are standard and operate well as single-phase machines even if all of the wire on the armature is not in use. This practice will

also be found in other power plants, notably that of the New Haven Railroad. The generator e. m. f. in this plant is lower than in some on account of the short distance over which power has to be transmitted and on account of this short distance, the generator voltage can be used directly on the line without the intervention of transformers.

In this plant there are two sources of excitation, a motor-driven set and two engine-driven sets. This practice, which has already been mentioned, insures excitation current under all circumstances. Obviously, all other parts of the system would be useless if there were no current for the excitation of the alternators.

The switchboards in the Port Huron plant are very complete as they control current for a large variety of purposes in addition to that for the main overhead circuit. These include the lighting of the station and surrounding buildings, both arc and incandescent lamps being used, the supplying of power to the motors for operating details of the plant and tunnel, the lighting of the tunnel, etc. Remote control switches are employed for this work, the operating parts of the switches being located in a locked enclosure with all apparatus accessible for inspection and repair. The small control switches are located on marble panels in the engine room.

ELECTRICAL DETAILS OF POWER PLANTS

Direct-Current Machines. The student may gather from the first part of this chapter that the direct-current generator has been entirely superseded by the alternator and the rotary converter. This is not true for there are many power plants which employ direct-current generators, in fact this is the case wherever the entire output of the plant is used in the immediate vicinity of the station. The increasing use of 1,200-volt equipment is due to the ability of a power plant to send its product farther without transformation or conversion. Direct-current plants are equipped with compound-wound generators direct connected to slow- or moderate-speed engines, but not in general to steam turbines. The speeds of the latter are too high.

The electrical connections of such machines are shown diagrammatically in Fig. 150. An essential feature of the arrangement is the heavy equalizer bar connecting the points between the armatures and series fields. This bar insures an equitable division of

current between the series fields and prevents the building up of one field at the expense of the others. Otherwise if two or more machines were operating in parallel, the one with the highest e. m. f. would take more than its share of the load. As its load increased its e.m.f. would increase also and thus it would immediately become very much overloaded.

The operation of starting up a compound-wound generator in a plant like this is of importance and will be explained in detail. Suppose that a new generator is to be started up and connected to the bus bars in addition to others already in operation. The engine of

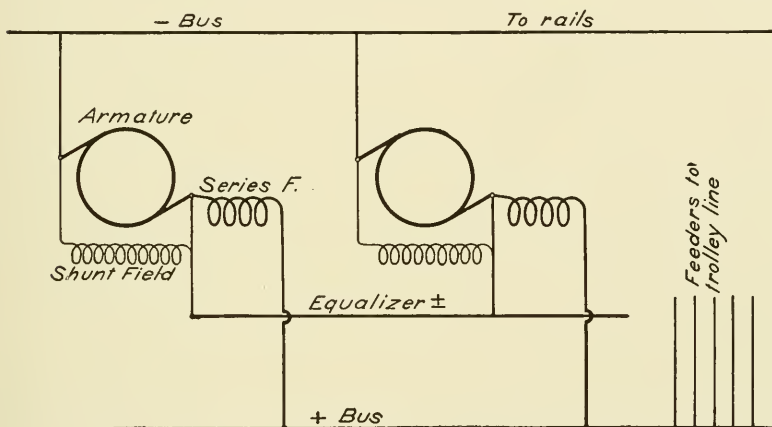

Fig. 150. Diagram of Connections for Direct-Current Power Plants

that generator is first brought up to speed. The switch controlling the shunt-field circuit is then closed, causing current to flow through the shunt fields; and the generator begins to "build up", its voltage gradually rising until it approximates that upon the bus bars. Before the generator is thrown in parallel with the others by connecting it with the bus bars, it is important that its voltage be nearly the same as that of the bus bars. Otherwise, if the voltage were too high, it might take more than its share of the load; while, on the other hand, if its voltage were too low, it might act as a motor, taking current from the bus bars. In order that the voltage of the generator to be thrown in shall vary in accordance with the bus-bar voltage, the next step in the operation is to close the positive switch, assuming that the equalizer switch on the generator has already been closed. This throws the series field of the new generator in parallel

with the series fields of the other generators. The voltage of the new generator will, therefore, vary just as the voltage on the bus bars; and, by adjusting the resistance of the shunt field, this voltage can be adjusted so as to be the same as that on the bus bars. The voltages on the bus bars and on the new generator are measured usually by a large voltmeter on a bracket at the end of the generator switchboard. By means of a voltmeter plug or of a push button on the generator panel, the voltmeter can be connected either to the

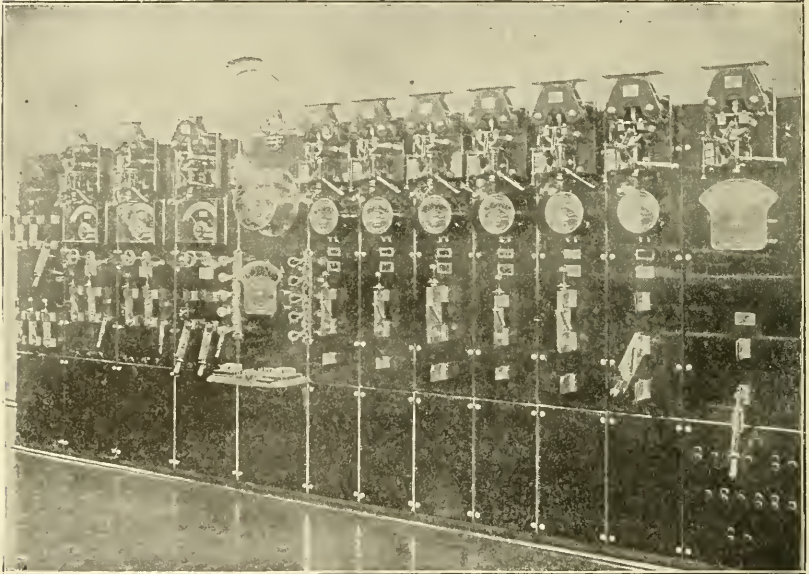

Fig. 151. Simple Railway Switchboard Panel

bus bars or to the new generator. When the two voltages are the same, the negative switch of the new generator can be closed, and it will operate in parallel with the other generators, taking its share of the load. If the attendant sees that any generator is not taking its share, he can raise its voltage by cutting out some of the resistance in series with its shunt field, thus forcing the generator to take more load.

Direct-Current Railway Switchboards. Railway switchboard panels for direct-current plants are of two varieties, viz, *generator panels* and *feeder panels*. A general view of a simple board is given in Fig. 151. The generator panel usually contains an automatic

circuit breaker which will open the main circuit to the generator in case of an overload due to a short-circuit. These circuit breakers contain a coil in the main circuit, which acts upon a solenoid. When the current in the coil exceeds a certain amount, the solenoid is drawn in, and a trigger is tripped. This allows the circuit breaker to fly open under the pressure of a spring. In one form of General Electric circuit breaker, the main contact is made by heavy copper jaws, but the last breaking of the contact is made between points which are under the influence of a magnetic field. This magnetic field blows out the heavy arc that would otherwise be established. In the I-T-E, Westinghouse, General Electric breaker, Fig. 152, and

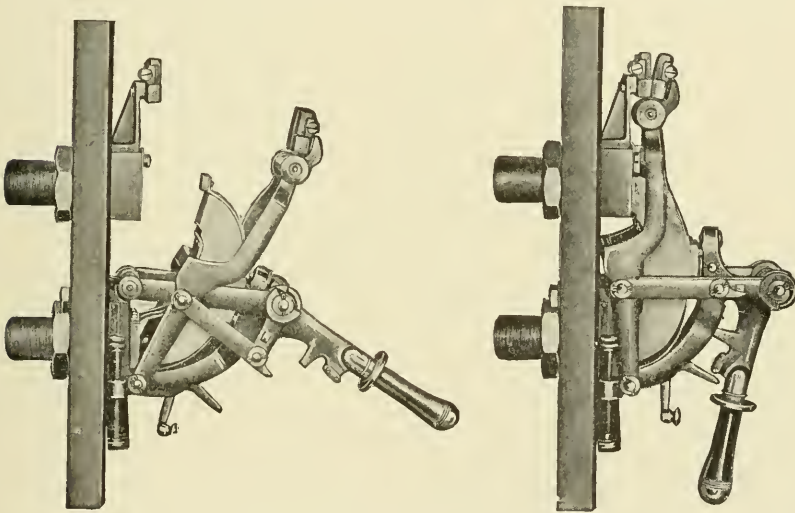

Fig. 152. General Electric Circuit Breaker

most other types of circuit breaker, the final breaking of the contact takes place between carbon points, which are not so readily destroyed by an arc as are copper contacts, and which are more cheaply renewed. The main contact through the circuit breaker, in either type, is made between copper jaws of sufficient cross-section for carrying the current without heating. These jaws open before the current is finally broken by the smaller contacts which take the final arc.

Two examples of circuit-breaker construction are shown in Figs. 152 and 153. In each, a laminated copper brush bridges between two copper terminal blocks, and is pressed firmly against these by

a toggle joint, operated by a handle. The closed position is maintained against the resistance of a spring by means of a catch which is released by the armature of a tripping coil which carries the main current. If desired a shunt tripping coil can also be used. The auxiliary contacts at which the circuit is finally broken are shown at the top. These open after the copper brush contacts.

On the switchboard, in addition to the circuit breaker, there

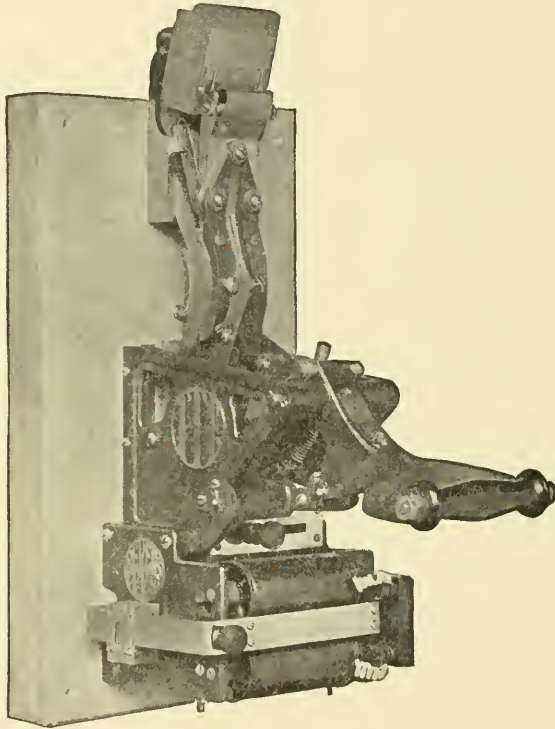

Fig. 153. I-T-E Circuit Breaker

is usually an ammeter to indicate the current passing from the generator; and a rheostat handle, geared to a rheostat back of the board, for cutting in and out the resistance in the shunt-field coils of the generator to reduce or to raise the voltage. There is also a small switch for opening and closing the circuit through the shunt-field coils.

The main leads from the generator pass through two single-pole quick-break knife switches. The most recent practice is to have the switches on the switchboard in only the positive and the negative

leads from the generator, leaving connection to the equalizer to be made by a switch located on or near the generator. However, all three leads may be taken to the switchboard, and a three-pole knife switch may be used instead of the positive and the negative switches.

The feeder panel is simpler than the generator panel, since it usually handles only the positive side of the circuit. Frequently two feeders are run on a single panel side by side. The feeder panel has an automatic circuit breaker, an ammeter for indicating the current on that feeder, and a single-pole switch for connecting the feeder to the bus bar. All generators feed into a common set of bus bars; and the positive bus bar continues back of the feeder panels so that all feeders can draw current from the bus bars. Fig. 151 shows a railway switchboard with 7 feeder panels at the right; 4 generator panels at the left; and in the middle a panel with an ammeter and recording watt-meter for measuring total output.

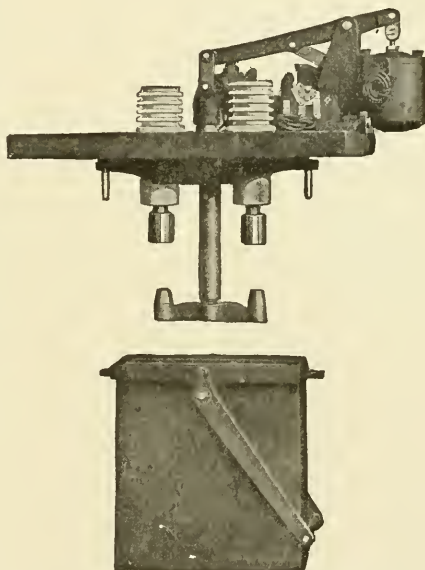

Fig. 154. Single-Pole Westinghouse Type E Electrically-Operated Oil Circuit Breaker

In some stations two, or even three, sets of bus bars are used, as it may be desired to operate different parts of the system at different voltages or to feed a higher voltage to the longer lines than to those near the station. In such a case double-throw switches are provided for connecting feeders and generators to either set of bus bars.

Alternating-Current Railway Switchboards. High-tension, a.c. switchboards differ from the d.c. boards principally in that the switches proper are not on the faces of the panels. They may be located directly behind the operating board or at some distance away. If the latter, they are "remote-control" switches. Alternating-current circuits are ordinarily broken under oil. A single pole,

electrically operated circuit breaker for remote control is shown in Fig. 154. The switch proper is in the oil tank and its conductors are brought through the porcelain bushings shown. The tank is lowered in the figure and contacts are open showing operating solenoid and knife switch for signal lamps on the side of the frame. The switch is closed when the lever on top is depressed.

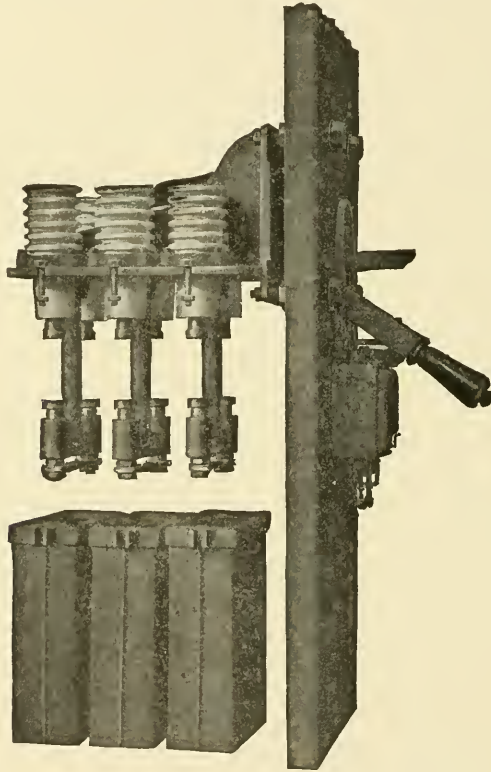

Fig. 155. Hand-Operated Automatic, 300-Ampere, 3-Pole Circuit Breaker. Open Position

Figs. 155 and 156 show, respectively, the open and closed positions of a hand-operated, automatic, 300-ampere, 3-pole breaker mounted on a panel. The switches are closed by a lever and held closed by a trigger; the latter is tripped by a solenoid through which flows the current of the circuit to be protected.

A switchboard, Figs. 157 and 158, using switches of the general type just mentioned is that of the St. Clair tunnel power plant.

In Fig. 157 the board is seen to consist of ten panels. Beginning at the left, the first panel contains a voltage regulator, a device for automatically weakening and strengthening the generator field to adjust the voltage to load and other changes; voltmeters; a frequency meter; and a synchroscope for use in synchronizing the generators preparatory to connecting them in parallel. The next two panels are for control of the exciting circuits. They contain, besides the measuring instruments and switches, the field-regulating rheostats. The fourth panel controls the lighting and power circuits of the plant. These circuits are on the same generator circuit as the locomotive line, the voltage of which is controlled by the Tirrill voltage regulator, already referred to. This panel is supplied with an oil circuit breaker. The next two panels, which are alike, control the two turbo-generators, and the sixth is the locomotive feeder panel. The remainder of the panels are for lighting and power circuits in and about the tunnel.

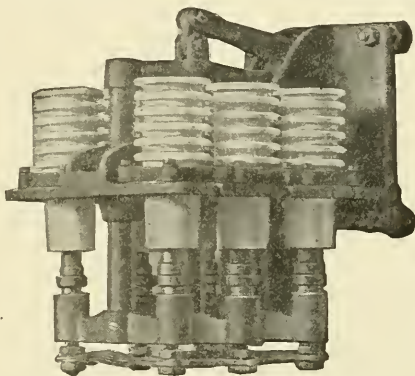

Fig. 156. Rear View Hand-Operated 300-Ampere, 3-Pole Circuit Breaker. Closed Position

Fig. 158 is a rear view of the board. It shows the several bus bars, wiring, oil switches, and circuit breakers.

Remote-control switches and circuit breakers are used for circuits of very high voltage or large capacity or both. These switches are operated by motors, solenoids, or compressed air. A large solenoid circuit breaker is shown in Figs. 159 and 160. The switch does not differ in principle from the smaller one shown but a more elaborate operating mechanism is used. The force for closing the switch is furnished by a large direct-current solenoid. The force acts through the chain and the system of levers shown in the figures as follows: The solenoid plunger pulls down on one end of a double lever hinged near the right-hand end to the upright frame. Pulling with the plunger are springs which assist the solenoid in starting the plunger in its downward movement. The left-hand end of the first lever is attached to a second lever near its middle. The second lever

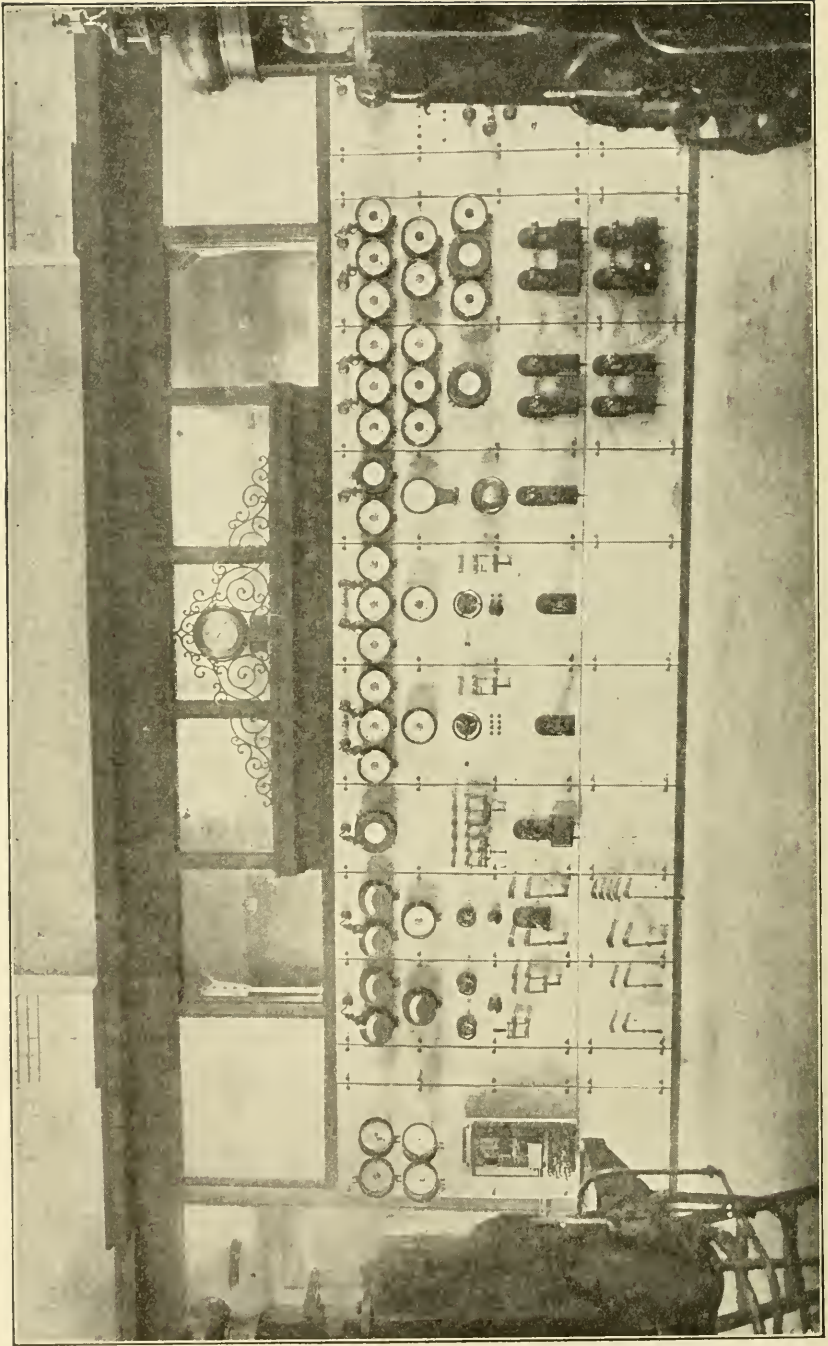

Fig. 157. Switchboard of the St. Clair Tunnel Power Plant, Front View

has its fulcrum at its left-hand end, which is hinged on the upper end of a link which has its fixed point on the base of the switch gear. The right-hand end of the second lever is connected to a bar

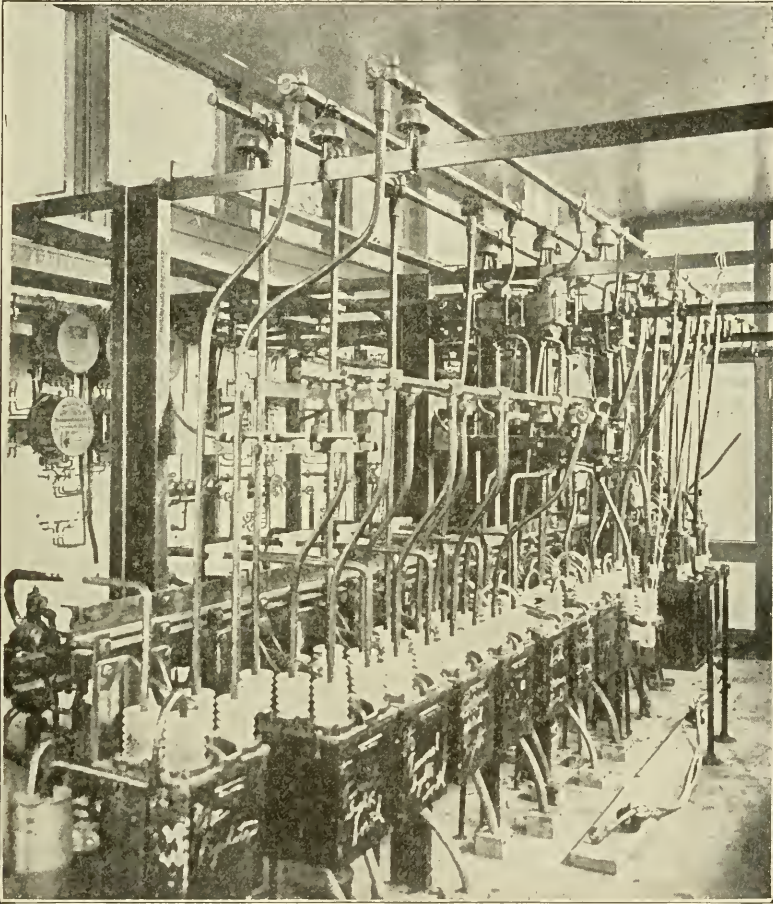

Fig. 158. Switchboard of the St. Clair Tunnel Power Plant, Rear View

from which hang the three switch rods. When the solenoid is energized—which it is in this case by 125-volt direct current—the switch rods are pulled up.

So far the apparatus described is merely a solenoid-operated switch. The one shown is also a circuit breaker. The switch-

closing current is on for but a short time, just enough to close the switch. The switch is held in the closed position by a simple toggle joint; when the switch rods are raised and the switch is closed the two arms of the toggle joint are in line with each other. A counter weight serves to hold the toggle joint in this position with some stability, and an arm which is connected with the toggle joint

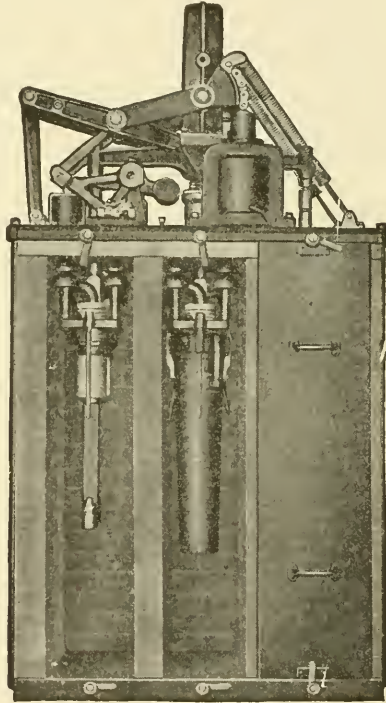

Fig. 159. 3000-Ampere, 3-Phase, Electrically-Operated Oil Circuit Breaker—1 Pole Enclosed; 1 Pole, Door Removed and Tank in Place; 1 Pole, Door and Tank Removed

rests above a small solenoid shown at the left. This coil carries the current of the circuit to be protected. If the current becomes excessive the core within the coil is attracted and the toggle joint is pushed out of its stable position. The switch then immediately opens under the action of gravity.

Fig. 161 shows a number of these switches in the power house of the Brooklyn Rapid Transit Company.

COST DETAILS OF POWER PLANTS

The function of a power plant is to generate electrical energy at a minimum total cost per kw. hour. The cost may be divided into two parts: (a) operation (labor, fuel, sundry); (b) interest, depreciation, maintenance, insurance, taxes.

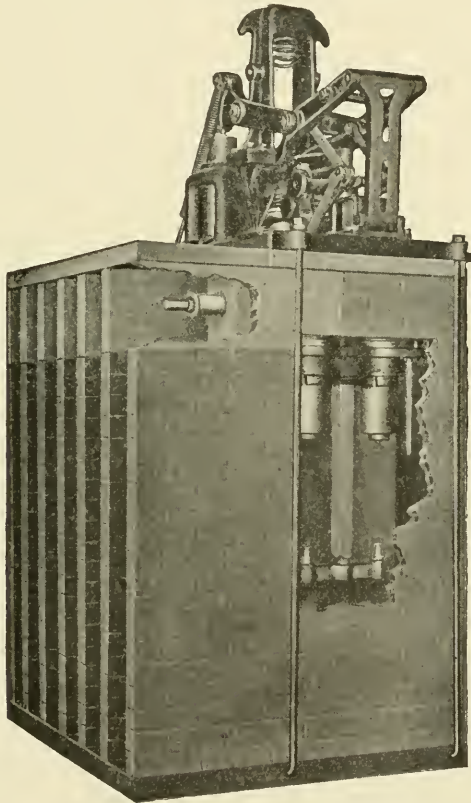

Fig. 160. Side View of Fig. 159 Showing Contact Mechanism

There is a tendency on the part of beginners to judge the cost of producing energy on the basis of operating expenses, but this is but a part of the total cost. The second part, sometimes called the "burden" or "fixed charges," may be nearly as great, in some instances, as the operating costs. The burden is a very variable quantity as it depends upon cost of real estate and other items which differ widely in different communities. Moreover it is difficult to assign

proper values to depreciation. One cannot tell how long an engine or generator will last nor how soon a new type will be developed which will require the discarding of the old equipment.

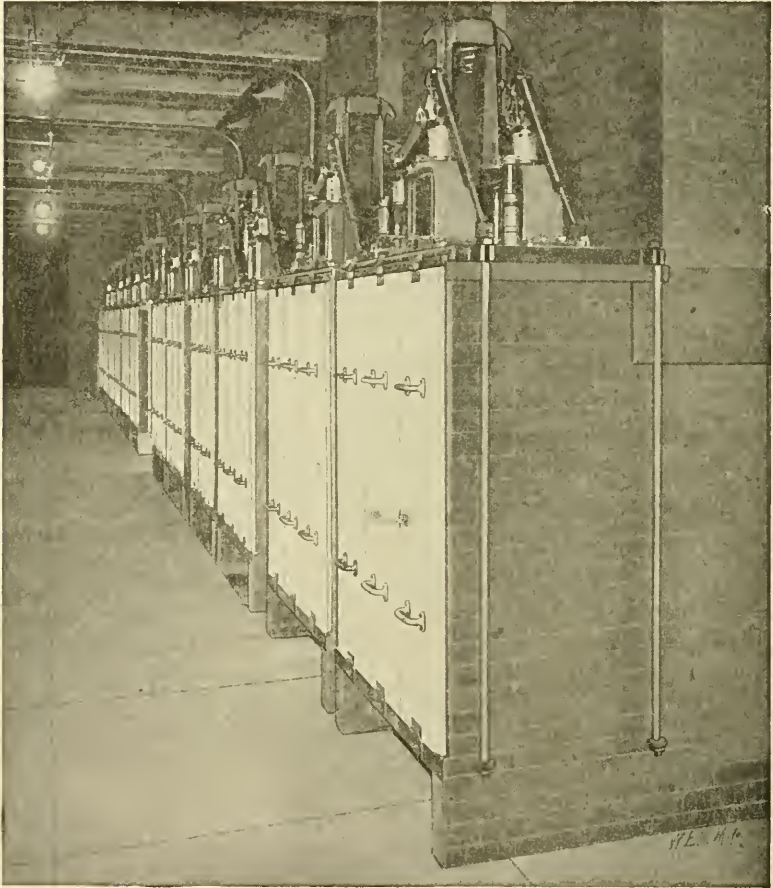
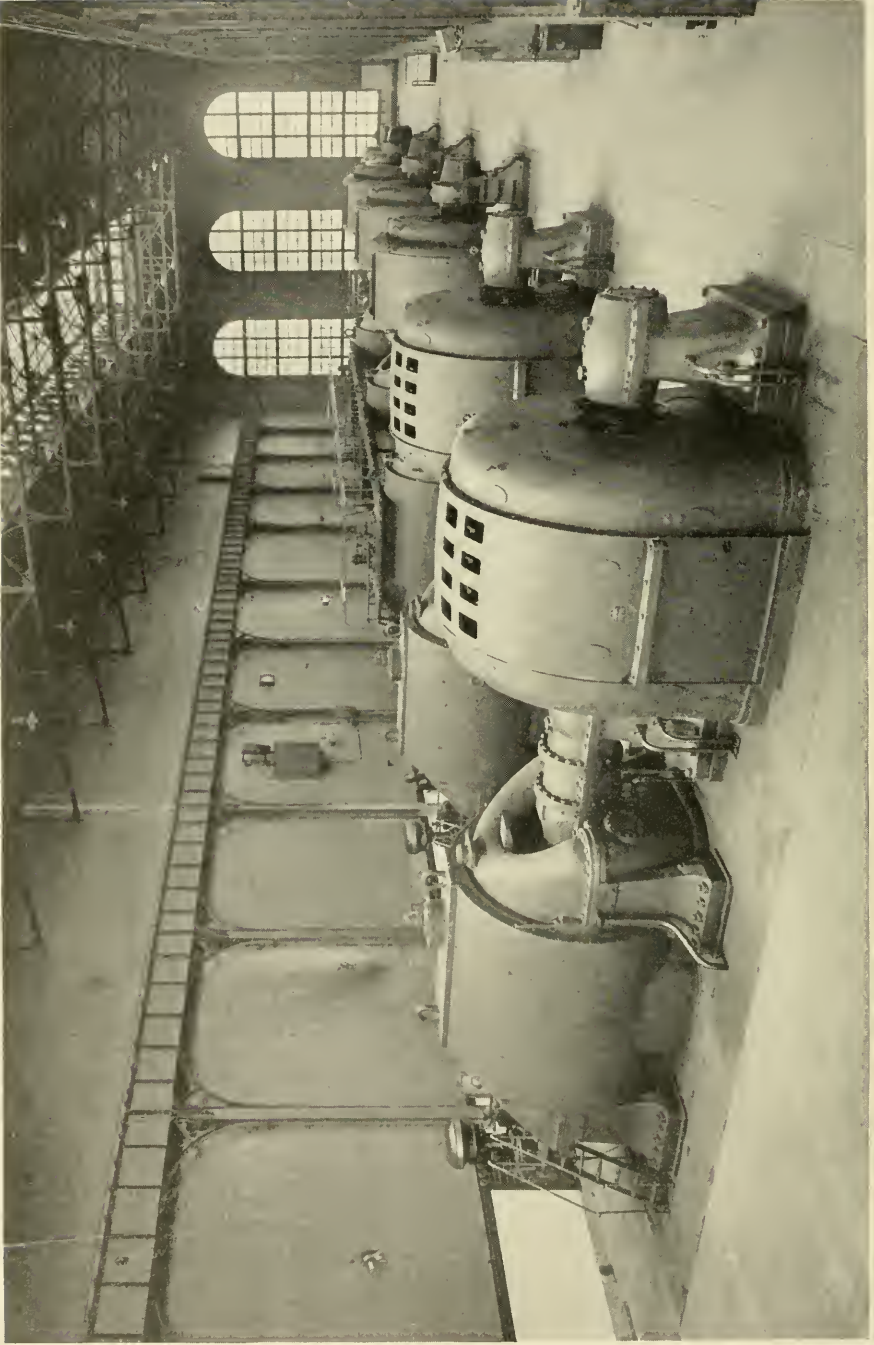

Fig. 161. Installation of Westinghouse Type C Electrically-Operated, Distant-Control Circuit Breakers

Some diagrams from the *Electrical World* show graphically the make-up of energy costs. In Fig.162 the per cent of total cost of fuel, labor, and sundries (oil, water, waste, etc.) for a number of stations are plotted against quantity of energy generated per year. The total in each case is 100 per cent. There appears to be no definite law connecting these variables. An average value of cost



WESTINGHOUSE-PARSONS TURBOGENERATORS, EACH OF 5500-K.W. CAPACITY, INSTALLED FOR THE PENNSYLVANIA TUNNEL AND TERMINAL COMPANY, LONG ISLAND

Courtesy of Westinghouse Machine Company

of fuel is about 56 per cent, of labor about 28 per cent, and of sundries the balance of 100 per cent.

Fig. 163 shows the relation of coal consumption to quantity of

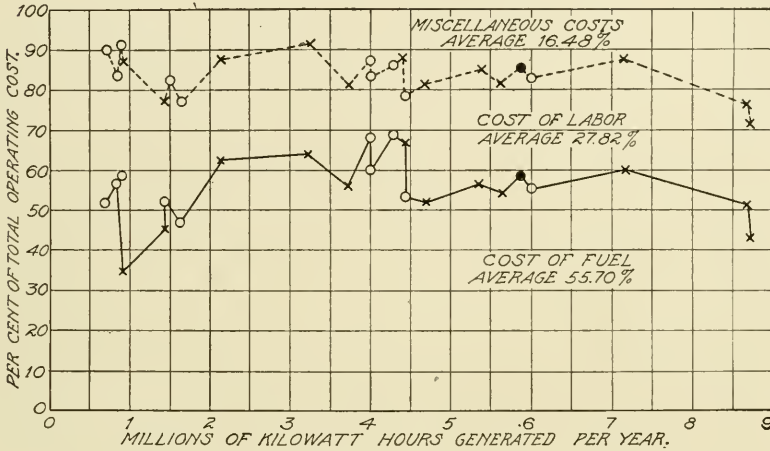

Fig. 162. Curve Showing Per Cent of Total Cost of Fuel, Labor, and Sundries for Given Quantity of Energy Generated Per Year

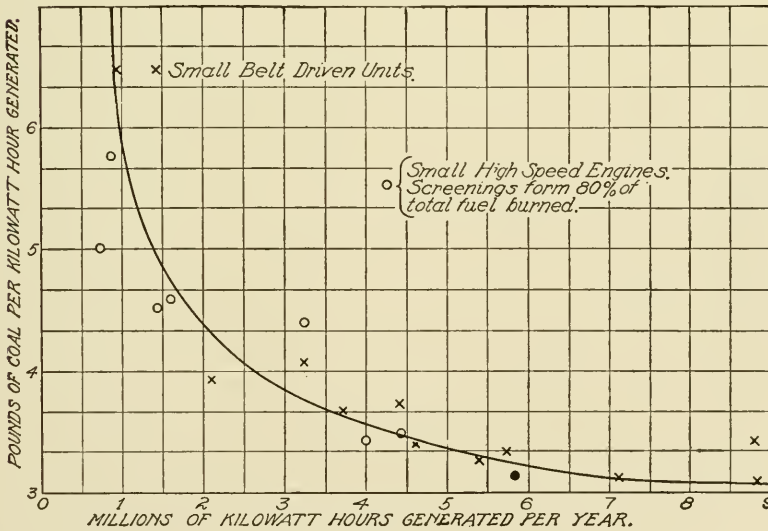

Fig. 163. Curve Showing Relation of Coal Consumption to Quantity of Energy Generated

energy generated. The value in the larger stations approaches 3 pounds of coal per kw. hour, which is a reasonable figure. Fig. 164

gives an idea of the amount of labor required in small stations. There is great divergence of practice shown here but the points give data for estimating the reasonableness of the number of men in a given plant.

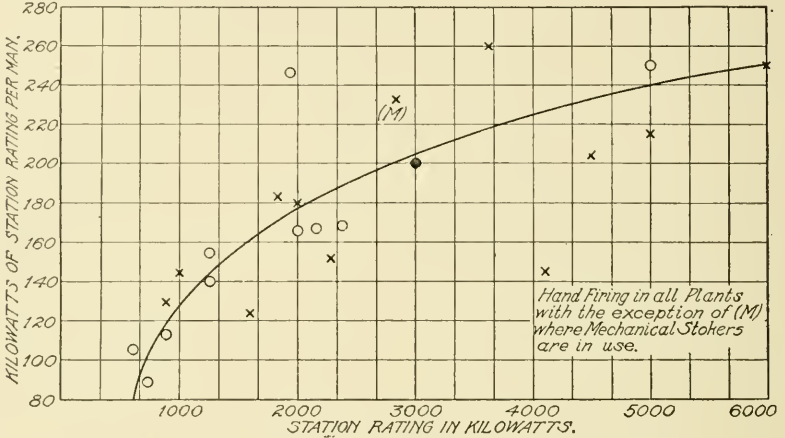

Fig. 164. Curve Showing Relation of Man Labor to Kws. Produced

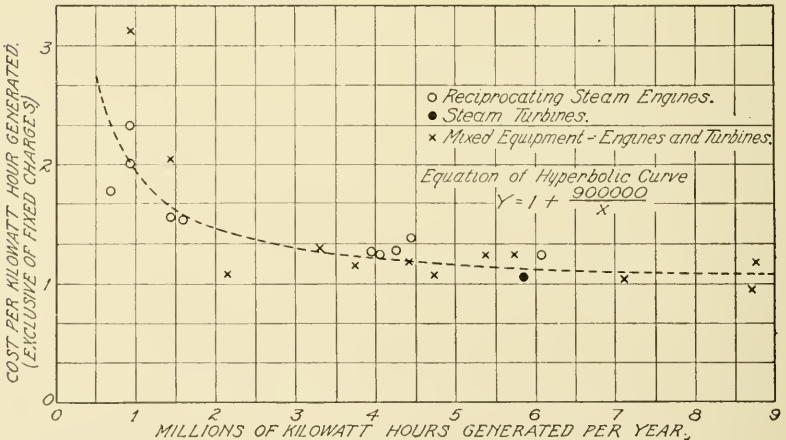

Fig. 165. Curve Showing the Total Cost per Kw. Hour Generated

Fig. 165 is a chart of great interest because it shows that the operating cost of energy bears a fairly systematic relation to the quantity generated. The cost seems to approach a value of one cent per kw. hour. This is higher than is the rule in large plants, but appears not unreasonable in plants of the mixed sizes indicated in Fig. 164.

Load Factor. The load factor has an important bearing on the cost of electrical energy. By the term load factor is meant the ratio of the average load to the rated output of a plant. A low load factor results in expensive energy because the equipment is not giving the output which it is able to give. Fig. 166 contains data which does not show any definite law connecting load factor and yearly output. It does, however, indicate that in these plants at least the load factor

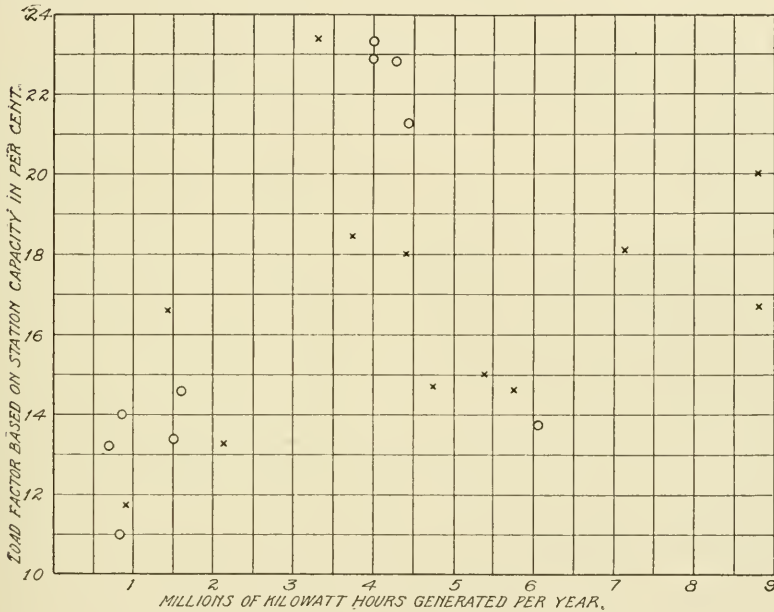

Fig. 166. Load Factor Percentages for Plants of Various Outputs

is not high. Anything which can be done to encourage the use of power during times of light load will improve the load factor and, as a rule, will cheapen the energy.

SUBSTATIONS

For efficiency of power generation and of power transmission over large areas it has been found best to use alternating-current power plants with substations for conversion of the power to direct-current form. A railway substation is in general a small building, or part of a large one, containing rotary converters, or motor-generator sets, for converting the current into the desired form.

The station contains all of the necessary auxiliary apparatus for operating the machinery including lightning arresters and switchboards. Storage-battery auxiliaries are in common use to provide direct current in case the power supply from the main station should fail.

Substations are located at various distances apart depending upon the amount of power which they are called upon to supply. For

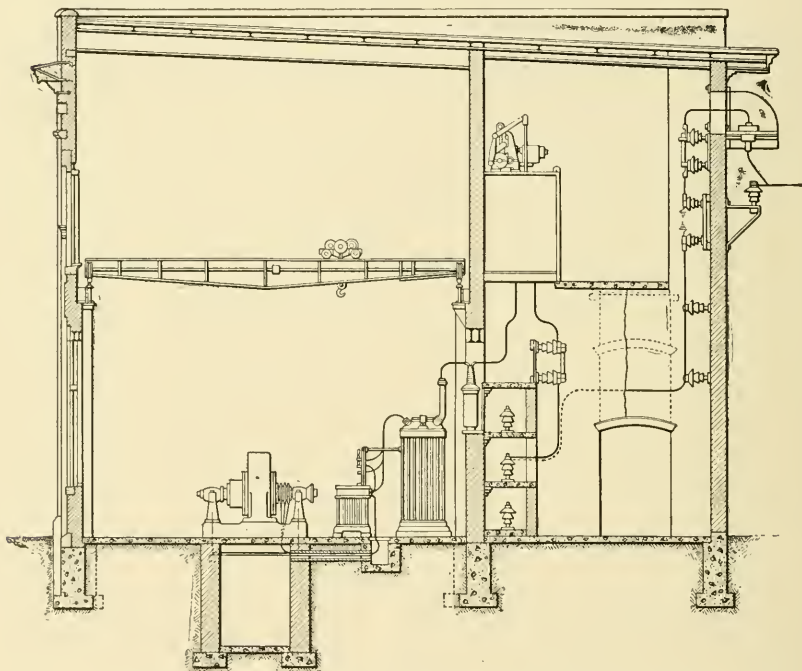

Fig. 167. Sectional Elevation of Substation for West Shore Railroad

ordinary interurban service at 600 volts they may be 10 miles apart. For heavy city service they must be much closer together. On 1,200-volt interurban roads they may be farther apart.

Figs. 167 and 168 show the details of a substation of the West Shore Railroad, an electrified section of which does a large interurban business in Central New York. In Fig. 167 we can trace the path of the power from the transmission line at the right to the rotary converter at the left. The transmission line is "dead ended" on bracket-

supported insulators on the wall. The wires enter the building through entries designed to provide high insulation and protection from the weather. Each entry is a large hole in the wall covered by a hood. The bottom of the hood is closed by a glass plate, in the center of which is a bushing. The wire leads to a disconnecting knife switch which is not suitable for opening the circuit with power on. Below this is a choke coil which deflects lightning discharges into the lightning arresters. The latter is not shown but it is connected to earth

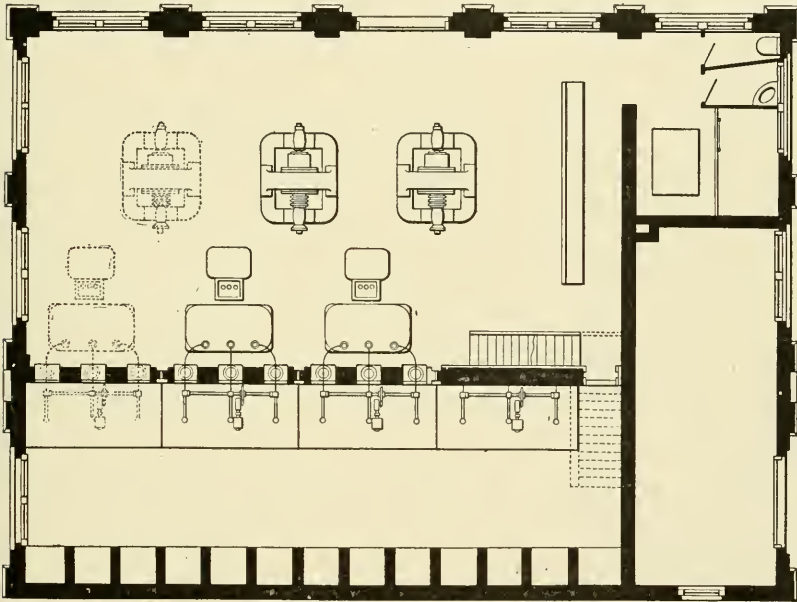

Fig. 168. Plan of Substation of West Shore Railroad

above the choke coil. The wire then leads to one of the bus-bar chambers, which are separated by incombustible partitions. From the bus bar the circuit continues through a second disconnecting switch to the oil-immersed, motor-operated circuit breaker located in the gallery above the bus bars.

The route is then as follows: Through a series transformer in which the current is transformed for measuring purposes to a magnitude adapted to the instruments; through the three-phase lowering transformer in which the voltage is reduced from about 35,000 to

370; through a reactive coil which is used for regulating the voltage in the converter; and finally to the a. c. end of the converter, from the d. c. end of which it emerges ready for distribution.

The figures show the simple building construction, the crane used for handling the apparatus, the switchboard, and other details. There is a small storage battery for supplying current for operating the switch gear but no large battery to be used as an energy reserve. The small battery is located in the basement.

TRANSMISSION

Power generated in the power station is transmitted to the substations at high tension, usually in the three-phase, alternating form. This variety of current uses the least copper in the line for a given efficiency of transmission. The current is, in general, transformed in the substation to the d. c. form for distribution to the cars, Fig. 169. An exception is in the case where the high-tension circuit goes direct to the cars, Fig. 170, transformers being carried on the latter to lower the voltage for use in single-phase series motors. Examples of this practice are found in the New York, New Haven and Hartford Railroad and the Erie Railroad electrifications.

From the substation, current flows to the cars either through overhead trolley wires, or through third-rail, mounted on the track.

Fig. 171 should be studied carefully as it represents a lay-out of power house, substations, and transmission system which was strictly up-to-date when it was installed a few years ago. The power house is at Anderson, Indiana, and from it the transmission lines radiate in several directions. The three-phase transmission circuits are indicated by light solid lines and the substations by small rectangles. The low-tension feeders are indicated by heavy solid lines and the trolley wire by light dot-and-dash lines. The sizes of the various wires and the distances involved are all plainly marked on the figure.

The overhead construction may be of the usual type with the trolley wire suspended from span wires or brackets, or it may be of the "catenary" type, as in Fig. 199. In this a steel messenger wire hangs from insulators in the form of a catenary curve—the natural

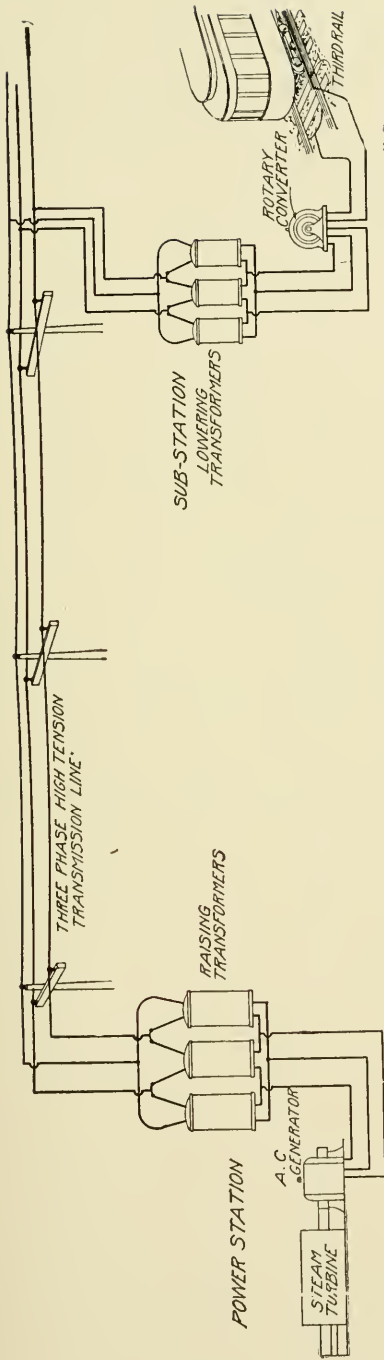

Fig. 169. Diagram of Connections for Three-Phase, Alternating Current, Transformed by Rotary Converter for Use on Third-Rail System

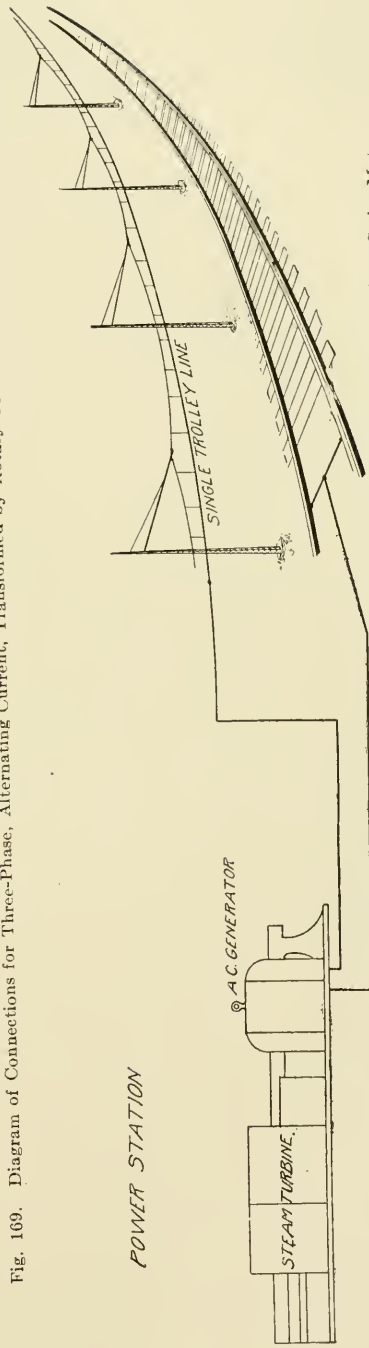

Fig. 170. Diagram of High-Tension Circuit Going Directly to the Cars, through Transformers into Single-Phase Series Motors

curve for a flexible cable suspended between two points. Attached to the messenger by hangers at frequent intervals is the trolley

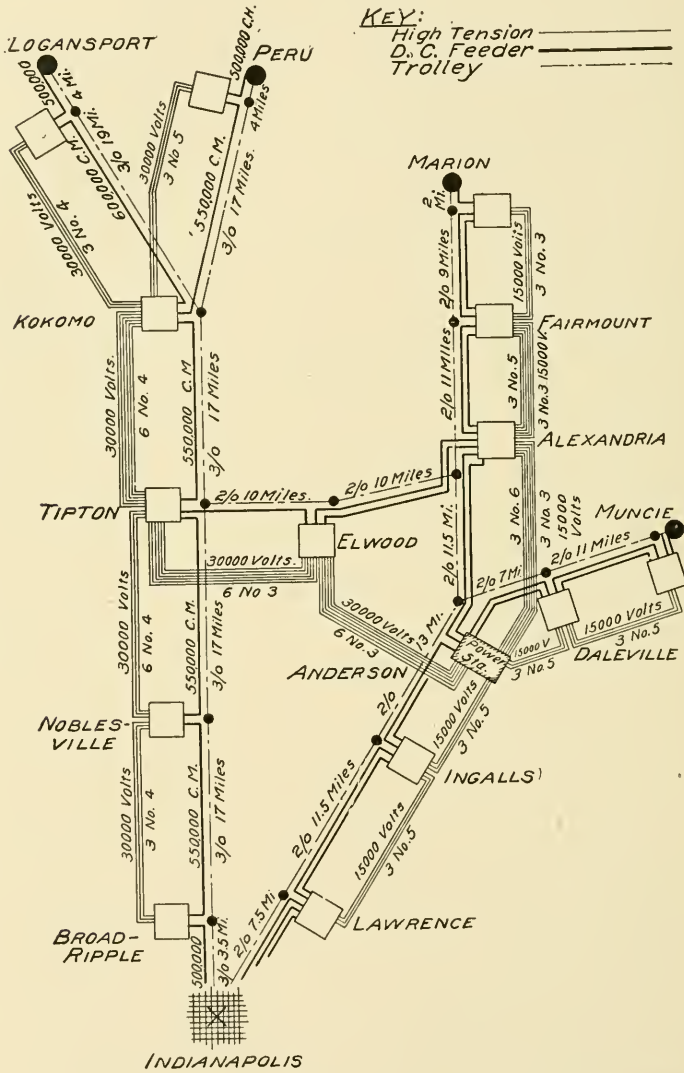

Fig. 171. Lay-Out of Power House, Substations and Transmission System Between Indianapolis and Neighboring Towns

wire, which may thus be suspended practically straight, that is, parallel to the track.

The signal system may be properly considered under transmission as it involves a wiring system for the operation of signals or for the telephone dispatching.

Wires. The wires for high-tension transmission lines are of hard-drawn copper or of aluminum. Copper wires are solid but aluminum wires are stranded, as solid aluminum wires are not as strong as stranded wires. This is true because in the manufacture of aluminum it is difficult to produce a wire which has absolutely uniform tensile strength, hence in a solid wire there may be weak spots which are avoided by the use of stranded conductor. Aërial high-tension conductors are always uninsulated.

The size of the conductors in the transmission line is determined by the allowable drop in e. m. f. and by the tensile strength which is necessary to withstand the strains due to the stretching of the wire from pole to pole, to the weight of accumulations of ice, and to the contraction of the wire due to lowering of temperature. In small lines the mechanical strength is most important and a wire smaller than No. 4 would probably never be used. In large lines the electrical properties are most important. A general rule—commonly known as *Kelvin's law*—for such lines is:

Such a size of conductor should be used that the interest on the money invested in the wire and such auxiliaries as vary with the size of the wire shall be equal to the value of the energy annually lost in the line.

This is a formal way of stating that if an additional expenditure for copper (or aluminum) will result in a saving greater than the cost, it will pay, and *vice versâ*.

The transmission voltage of a line is largely chosen on the basis of experience and there is no simple method for determining the proper value in general. As the voltage is raised, the size of the conductor may be reduced with the same amount of power transmitted. With the same power loss in the line, the size of conductor may be theoretically reduced as the square of the increase of voltage. This follows because the current is inversely proportional to the voltage (for the same power). As the power loss in the resistance of the line is proportional to the square of the current, it is inversely proportional to the square of the voltage. It is quite possible, however, in a given case that the reduction in size of the wire is

limited by mechanical considerations so that it is not always possible to take full advantage of the increased voltage. An increase in the voltage is accompanied by additional expense for insulators, for it is more difficult to insulate a high-tension line than a low-tension line. Not only are the high-tension insulators more expensive but they are more difficult to maintain. On the whole, therefore, a moderate transmission voltage is chosen which will give the most economical all-round results. At present the upper limit of voltage is about 110,000 but this is quite extreme. About 30,000 volts may be considered conservative practice for railway work. Over small areas e. m. f.'s of 6,600 volts are used even with very large quantities of power.

The use of cables for the high-tension circuits of electric railway work is limited to a very few cases. It is difficult and expensive to insulate cables for very high voltages, hence their use is general only in cities where the use of exposed high-tension wires is prohibited. Fortunately under this condition the area of distribution is not great and it is possible to use voltages which are practicable with cables.

Poles and Towers. Transmission wires are supported on wooden poles or on steel towers. The latter are used to an increasing extent because they are durable and because they permit the use of long spans as they can be constructed of any necessary height. Concrete poles are successfully made at present and undoubtedly have a future before them. Wooden poles are still in general use, however, and are made of Georgia pine, white cedar, chestnut, redwood and other more-or-less durable woods. The variety used in any locality depends to some extent upon the natural timber of the region. The poles are not usually dressed although they are sometimes dressed to octagon form where appearance is important.

To the poles are attached Georgia pine cross-arms, the poles being notched or "gained" to receive them. The cross-arms are held in place on the poles by bolts passing entirely through both. The cross-arms are braced with galvanized iron straps which are placed at an angle of about 45 degrees. The braces are attached to the cross-arms by carriage bolts and to the poles by lag screws. The cross-arms are bored to receive locust pins or iron bolts, upon which are mounted the glass or porcelain insulators. The upper

surface of the cross-arm is rounded so that it will shed water readily; the cross-arm is thoroughly coated with metallic paint.

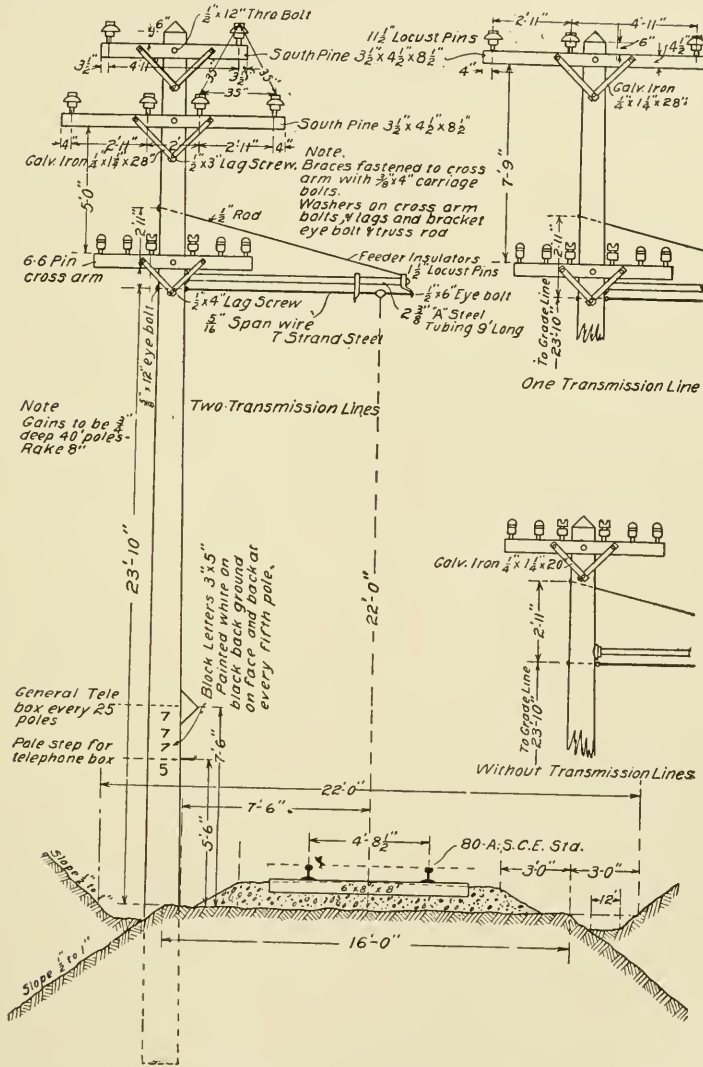

Fig. 172. Diagram of Construction of Single-Track Interurban Trolley Road

Concrete poles are moulded in a taper form somewhat similar in shape to wooden poles but of nearly square cross-section. The corners are chamfered to prevent chipping and to facilitate mould-

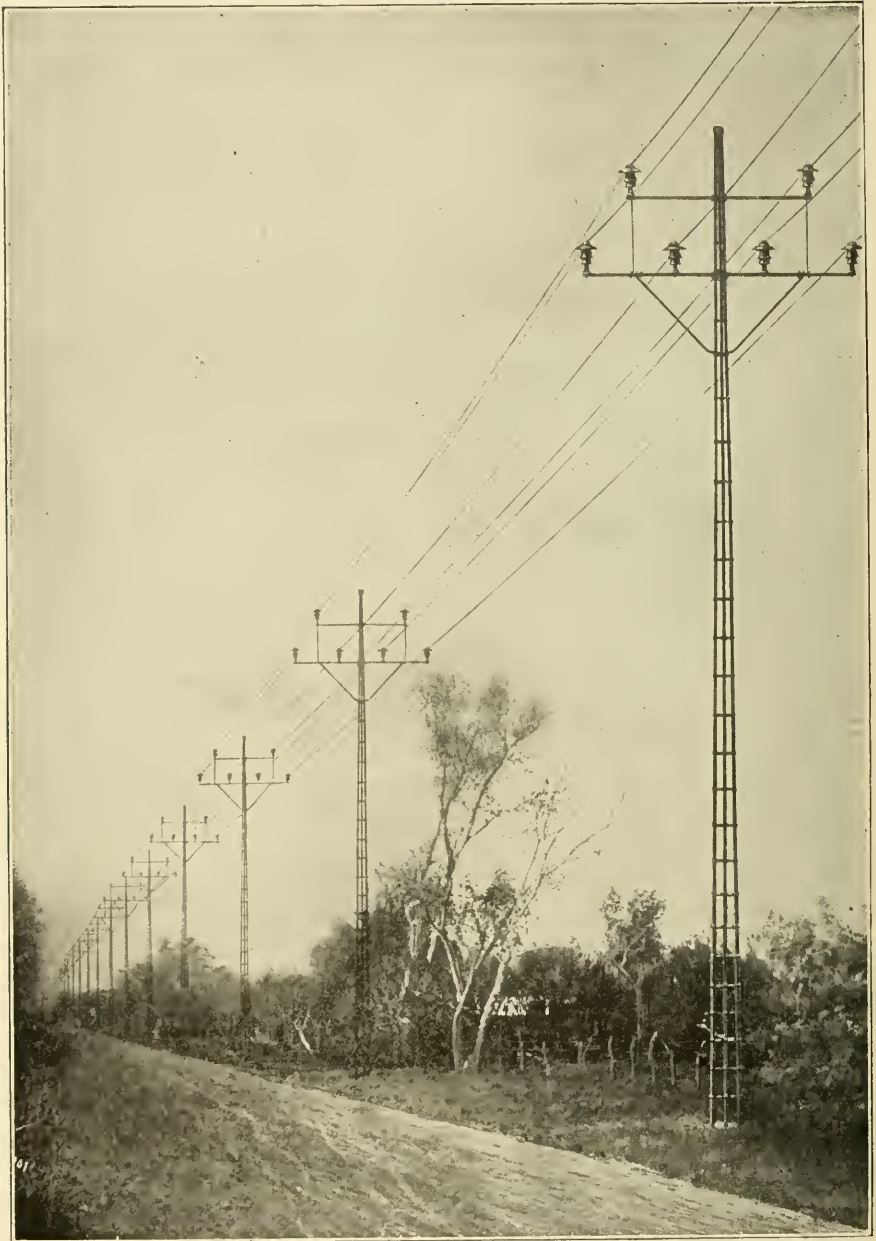

Fig. 173. Steel Pole Construction for High-Tension Circuit

ing. The poles are reinforced with steel rods and the "gains" for the cross-arms are moulded in the proper positions. Steps are also moulded in the poles as climbing-irons would be useless in this case. While these poles are very heavy, they will undoubtedly prove durable and the results of the early installations will be watched with interest.

Poles are set in the ground 6 feet more or less, depending upon the height of the pole and the character of the soil.

Fig. 172, which represents the construction of a single-track interurban trolley road, shows plainly at the left the construction of the transmission line. The same pole line in this case serves also to support the trolley brackets and to carry the telephone line used for dispatching. In this figure the upper cross-arms are provided with six insulators, one three-phase line being mounted on each side of the pole.

Steel structures for supporting transmission lines are coming into use. As they are more expensive, in first cost at least, than

wooden poles they usually must be placed at greater distances apart

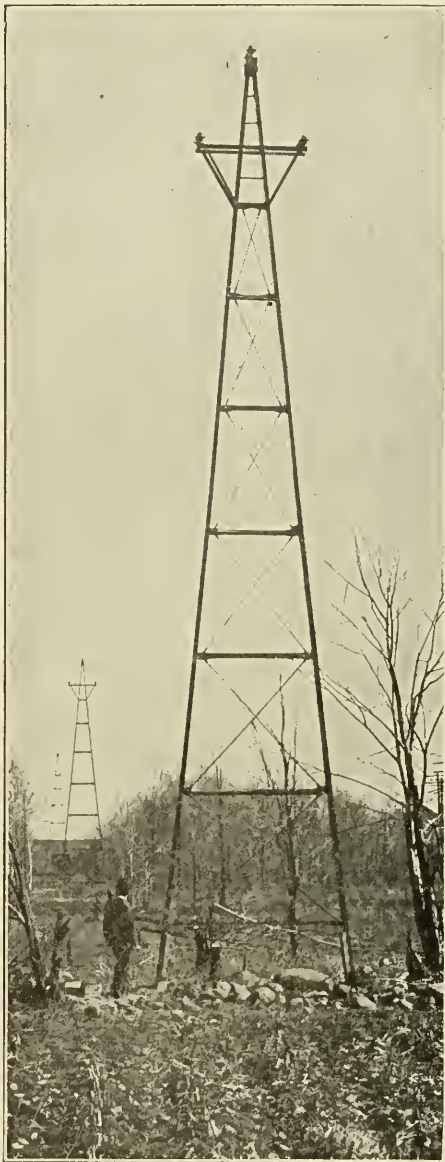

Fig. 174. Steel Tower with only Side Bracing

in order to render their use economically practicable. Where wooden poles are placed from fifty to thirty to the mile, towers may be placed from thirty to as few as ten to the mile.



Fig. 175. Steel Tower with Insulators Mounted One above the Other

The steel tower, built up of light galvanized iron angles was in use for supporting windmills before it was required for electric power transmission purposes.

It was a comparatively simple matter to adapt it to a new use. Towers of practically the same form as used in windmill practice are used in many transmission lines. There are other forms, however, which have been developed particularly for this service. Fig. 173 shows a steel substitute for the wooden pole which consists of three light steel uprights separated by cross-pieces. Steel cross-arms form a part of the structure. The arrangement of insulators is as in the preceding example. A flat structure is shown in Fig. 174 which is strongly braced for side strains but offers no resistance along the direction of the transmission line. The line, in this case, is anchored by guy wires at intervals. Fig. 175 is a slightly different form in which the two transmission lines provided for have their insulators mounted one over the other. In both of the flat structures there are cross-pieces every few feet and the whole is strongly braced by light diagonal wires attached to the corners of the spaces thus formed.

Insulators. In high-tension transmission lines for railway work, both glass and porcelain insulators are employed. The glass is cheap and it may be easily inspected for flaws. Porcelain is, however, usually considered more reliable. The insulators are

made up in shells which are cemented together, the shells of small insulators being often cemented by the glaze on the porcelain.

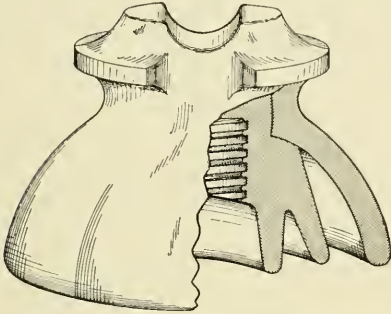

Fig. 176. High-Tension "Pin" Insulator

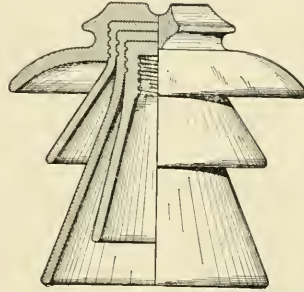

Fig. 177. High-Tension Petticoat "Pin" Insulator

The shells are so designed as to form "petticoats" which furnish a long leakage path for the current over the surface and thus reduce the leakage.

The insulator is made of such size that the striking distance from the conductor to the pin shall be great enough to prevent the breaking down of the air and the consequent short-circuit of the line. On the top of the insulator is a groove in which the conductor lies and below is a flange to which some kind of a binding or clamping device is attached.

Typical high-tension insulators are shown in Figs. 176 and 177. The form of insulator described is the "pin" insulator, so-called on account of the manner of mounting.

This form has its limitations because of the mechanical weakness of the pin in very high insulators. A new type has, therefore, been

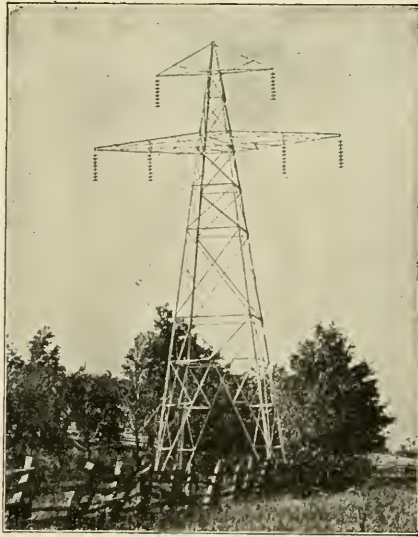

Fig. 178. Modern High-Tension Tower with Suspension Insulators

developed in which the conductor hangs from the insulator and the insulator from the cross-arm. Fig. 178 shows a very modern high-

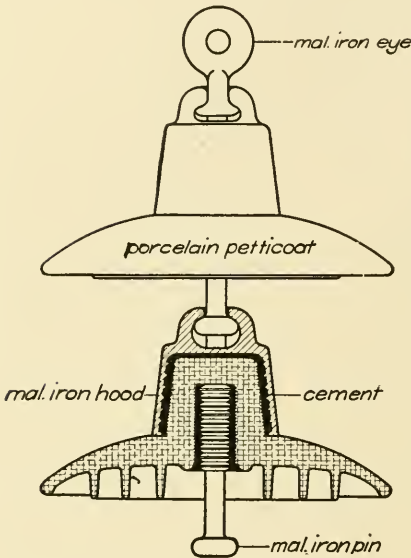

Fig. 179. Section of Suspension Insulator

tension tower equipped with suspension insulators. The wires, which are not shown, hang from the bottom insulators. The insulator is seen to consist of a string of shells, the number of shells being determined by the voltage which is to be insulated against. In this case the line is able to carry 150,000 volts and each insulator has eight sections.

In Fig. 179 is shown a section of a typical suspension insulator. It is a porcelain shell with galvanized iron fittings by which it may be attached to similar shells above and below.

DISTRIBUTING SYSTEM

The elements of the distributing system are: (a) the trolley wire or third rail through which the current flows to the cars; (b) the feeders through which the trolley wire or third rail is supplied with current; and (c) the rail return through which the current gets back to the station or substation.

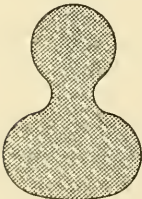
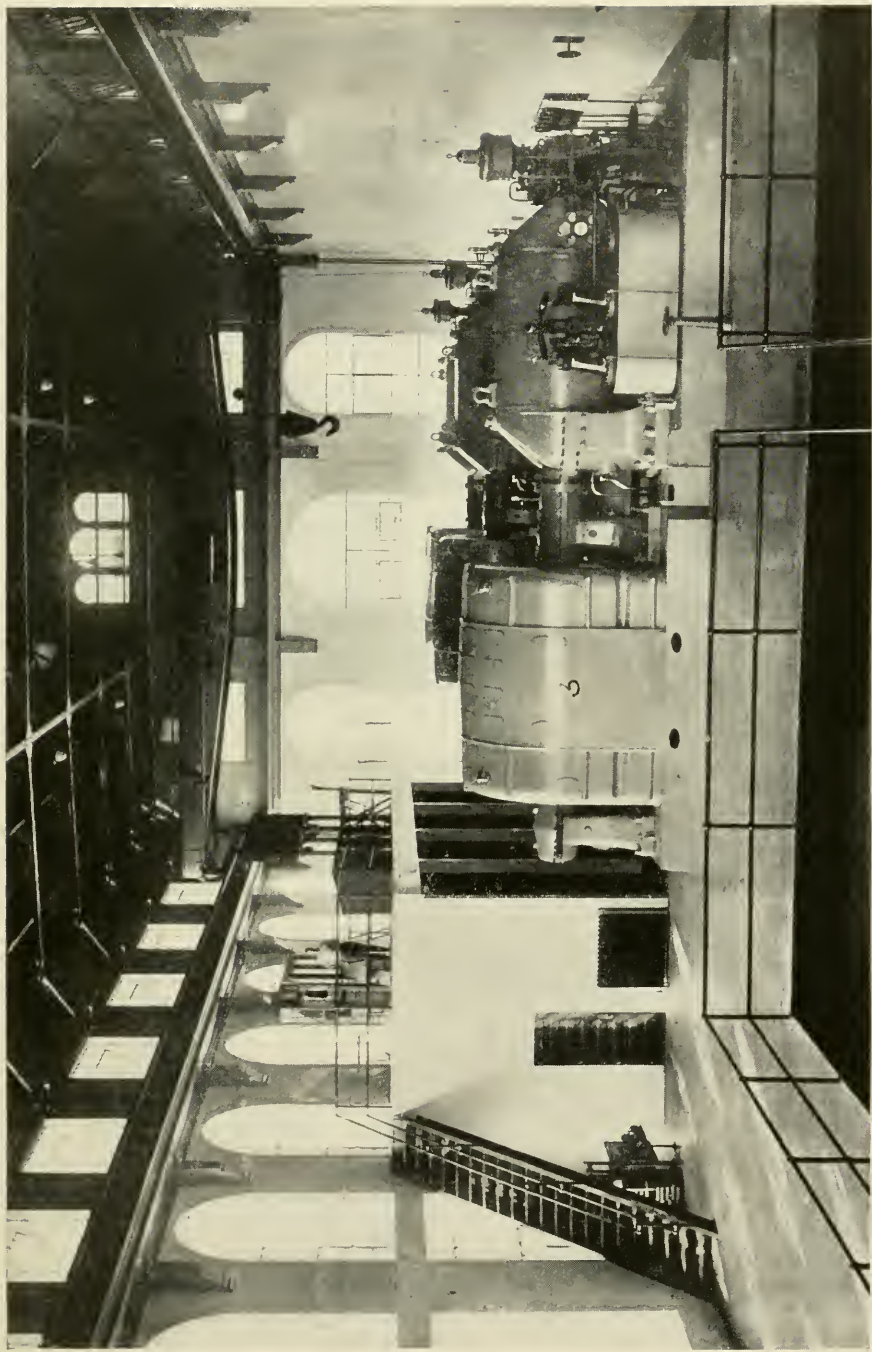

Fig. 180. Section of a "Figure 8" Trolley Wire

OVERHEAD CONSTRUCTION

In direct-current distribution, span or bracket construction is usually used in the support of the trolley wire.

Trolley and Fastenings. The trolley wire, of hard-drawn copper, is suspended from the span wires or brackets in such a way as to permit of an uninterrupted passage of the upward-pressing trolley wheel. The trolley wire itself may be either round, grooved, or "figure 8" in section. Where a round wire is used, No. 00 B. & S. gauge is the most common size. "Figure 8" wire, so-called from its



THREE 700-K.V.A. THREE-PHASE, 6600-VOLT GENERATORS, INSTALLED FOR THE NORTHERN OHIO TRACTION AND LIGHT COMPANY, CUYAHOGA FALLS, OHIO

Courtesy of Westinghouse Machine Company

section, which is shown in Fig. 180, is designed to present a smooth under-surface to the trolley wheel, which will not be interrupted by

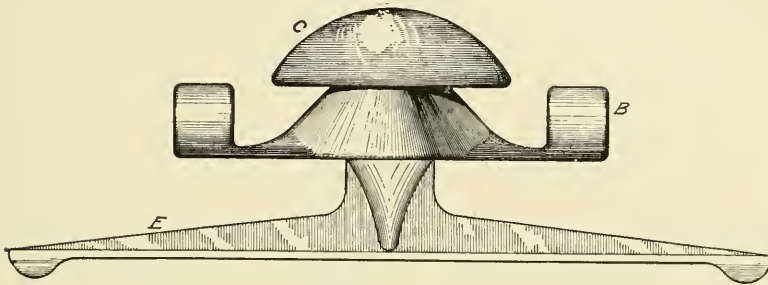

Fig. 181. Hanger and Ear for Round Trolley Wire

the clamps or ears used to support it. Clamps are fastened to the upper part of the "figure 8". The grooved wire, which is rolled with grooves into which supporting clamps fasten, presents a smooth under-surface to the trolley wheel. The usual support for round trolley wires consists of a hanger *CB* and an ear *E*, Fig. 181.

Hanger. The construction of the hanger is shown from the cross-sectional view in Fig. 182. In the cap *C*, Fig. 181, is moulded the head of a bolt. The cap, which is made of insulating composition, rests on the malleable iron body of the hanger, the under side of which is of conical form to fit the cone, which is below the cap and of the same material. In the cone is moulded an iron washer. When the hanger is assembled, as in Fig. 182, a lock nut on the bolt is used to clamp the whole firmly together. The washer in the cone gives a hard bearing surface for the lock nut. The threaded portion of the bolt projects below the hanger and on this the ear or clamp is screwed. Other forms of hanger, involving the same general principles, are shown in Figs. 183 and 184. In mounting the hanger on a span wire, the wire, which is a stranded galvanized steel wire, is passed under the bent lugs and looped over the neck of the hanger.

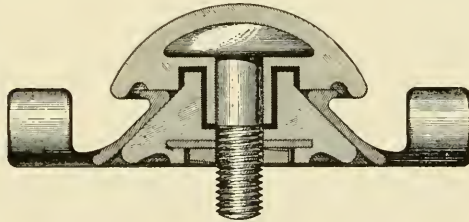

Fig. 182. Cross-Section of Hanger Showing Construction

Ears. Fig. 181 shows the construction of the cast copper ear which is soldered to a round trolley wire. It is grooved on the under side and has small projecting ears to hold the trolley wire during the soldering process and to supplement the solder in supporting

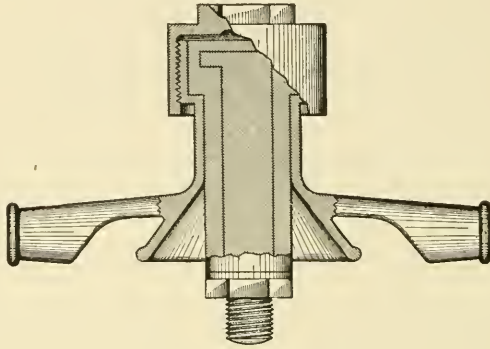

Fig. 183. Section of a Hanger

the wire. A section of the ear with the trolley wire soldered in place is given in Fig. 185.

Clamp. The construction of the clamp used with grooved and "figure 8" wires may be clearly understood from Figs. 186, 187, and 188. In these figures, the clamp, which is attached to a suitable wire, is in two pieces which are held together and against the wire by screws. In other forms of clamp, different devices are employed to accomplish the same purpose but the general principle is the same.

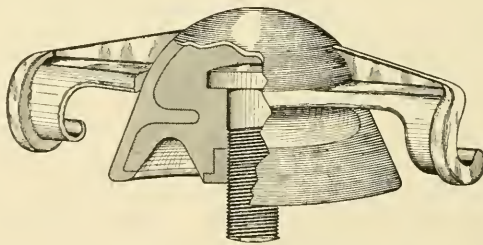

Fig. 184. Section of a Hanger

Section Insulators. Section insulators are usually placed in the trolley wire at regular intervals, Fig. 189. The insulator consists of terminal clamps for the trolley wire connected by wooden insulating pieces. In each terminal there is a binding screw con-

nection for the wire, which usually is connected to a single-pole switch; this bridges the connection and short-circuits the insulator. A hanger is attached to the middle of the upper wooden piece by means of which the insulator is supported from a span wire.

The purpose of the insulator is to insulate one section of trolley wire from the next, so that in case the trolley wire of one section breaks, or is grounded in any other manner, that section can be disconnected and the other sections on either side kept in operation. In large city street-railway systems, each section of trolley wire usually has its own feeder or feeders, independent of the other sections. This feeder is supplied through an automatic circuit breaker

at the power house. In case a certain section of trolley wire is grounded, the large current that immediately flows will open the circuit breaker supplying that section; but unless the ground contact is of an extremely low resistance, it will not affect the operation of the other feeders. Should it be of sufficiently low resistance to cause all the generator circuit-breakers to open, it would, of course, interrupt the entire service temporarily; but usually the circuit breaker on any individual feeder will cut that feeder out before all the circuit breakers will open.

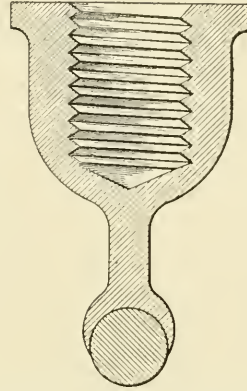

Fig. 185. Section of Ear with Trolley Wire Soldered in Place

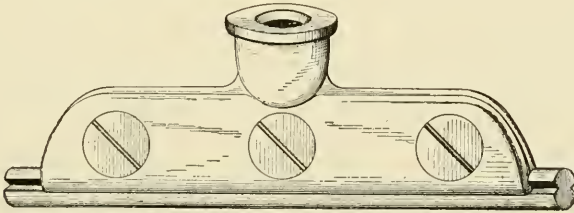

Fig. 186. Clamp Used with Groove Trolley Wire

Span-Wire Construction. In some interurban roads and in most roads in city streets, the trolley wire is suspended from span wires stretched between poles located on both sides of the road-bed or the street. These span wires are of $\frac{1}{4}$ -inch or $\frac{3}{8}$ -inch galvanized

stranded steel cable. In order to add to the insulation between the trolley wire and the poles at the side of the street, what is called

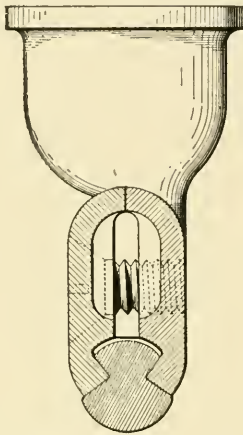

Fig. 187. Section Through Clamp Shown in Fig. 186

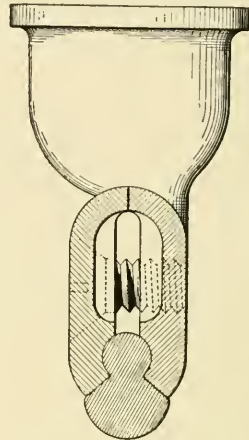

Fig. 188. Section Through Clamp for a "Figure 8" Wire

a *strain insulator*, Fig. 190, is sometimes placed in the span wire. This is an insulator adapted to withstand the great tension put upon it by the span wire. Means are usually provided for tightening the span wires as they stretch and as the poles give under the strain. The insulator may have a screw eye or a turnbuckle for that purpose.

Iron or steel tubular poles are used in some city practice. These are neat, durable, and strong. Usually wooden poles are used on account of their low cost. The insulation of the wooden

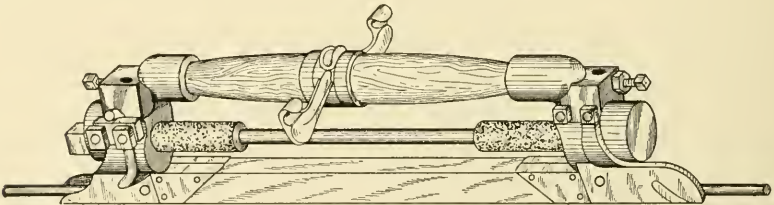

Fig. 189. Details of Section Insulator Used at Intervals in Trolley Line

pole is greater than that of the iron pole, which is advantageous. Fig. 191 shows a simple span-wire construction for an interurban road. In this there are no strain insulators shown; if used they would be inserted in the span wires near the poles.

In supporting trolley wire on curves it is necessary to pull the wire from one side in order to make it conform to the curve of the

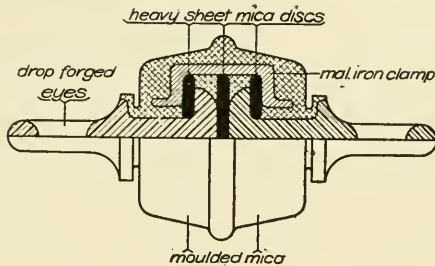

Fig. 190. Section of Strain Insulator

track. Figs. 192 and 193 show how this may be accomplished in simple cases and the same general principle will apply in more complicated ones. To the trolley wire are attached a number of curve hangers or "pull-overs." A curve hanger is an ordinary hanger with the addition of one or two eyes to which the guy wire can be

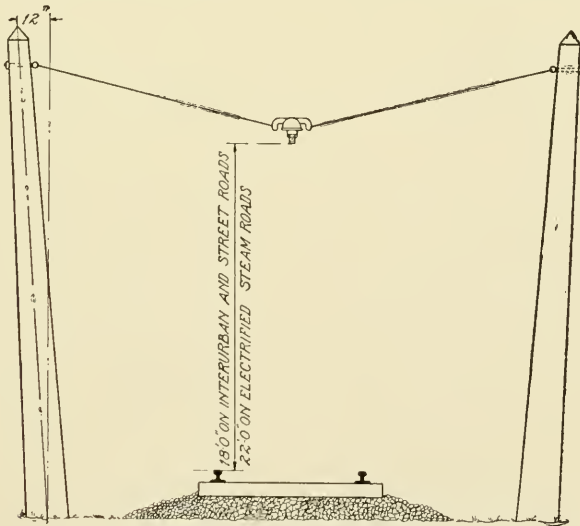

Fig. 191. Span Construction for Single Trolley Wire

attached. In the case shown in Fig. 192, the tangent wire is supported at each end of the curve by a pair of poles and a span wire. These poles also serve to anchor the trolley wire at the curve, the anchor wires being shown. On the curve there are six hangers; to

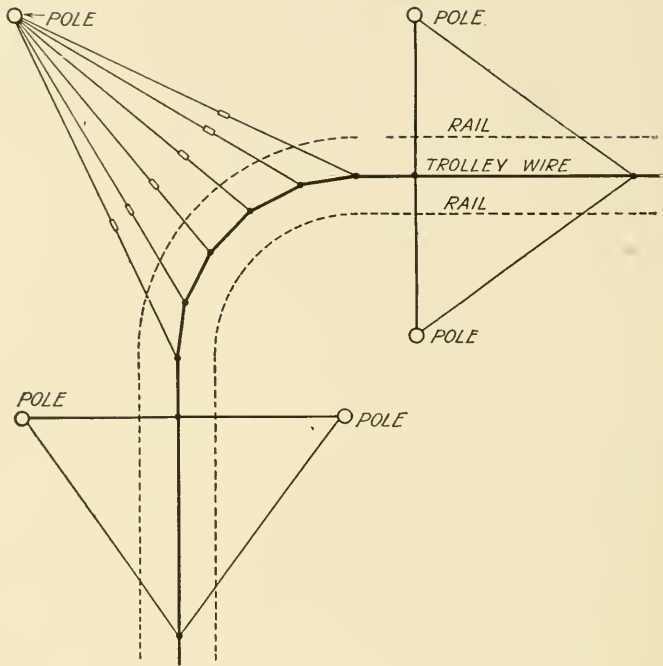

Fig. 192. Line Construction on a Curve Using Five Poles

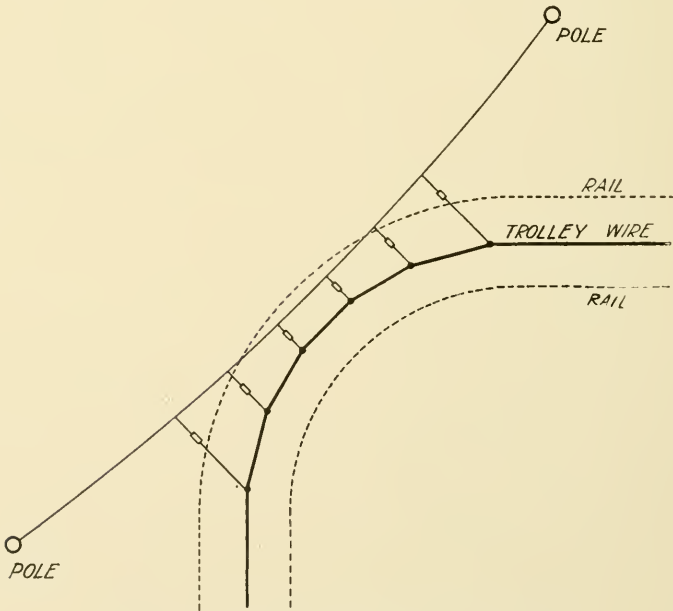

Fig. 193. Simple Curve Suspension Using Two Poles

each hanger is attached a pull-over wire; and all of the pull-over wires terminate in a pole. Strain insulators are shown in these guy

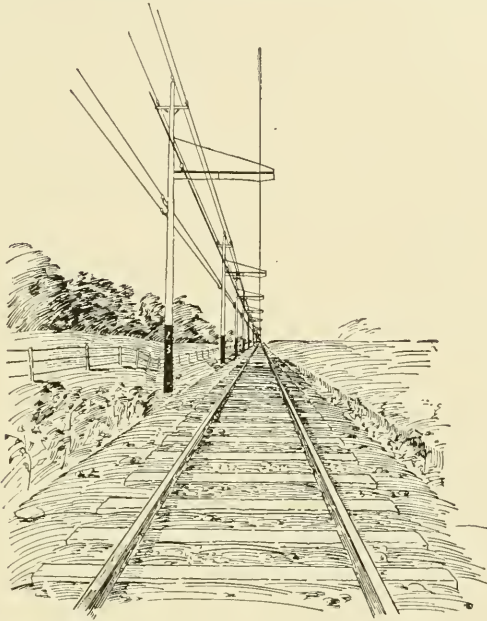

Fig. 194. Bracket Line Construction

wires; although not absolutely necessary, they greatly improve the insulation of the line and should in general be used. In the simpler curve suspension shown in Fig. 193, the pull-over wires are attached

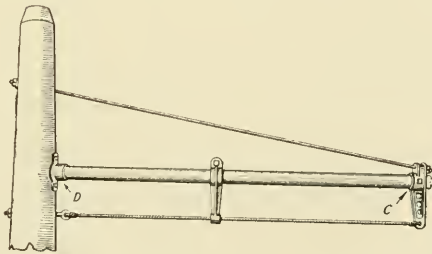

Fig. 195. One Type of Bracket for Trolley Line

to another wire which spans the two poles. This is a cheaper construction than the other but not as substantial.

Bracket Construction. A cheap method of construction consists in supporting the trolley wire from brackets mounted on a

single pole line. The bracket is a piece of pipe attached at one end to the pole and supported at the outer end by a wire fastened to the

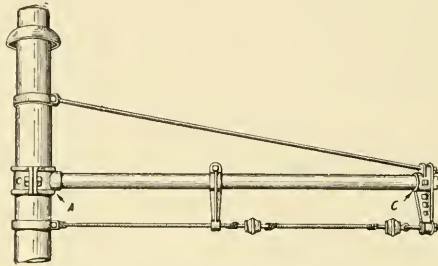

Fig. 196. Bracket Used on Metal Poles

pole a couple of feet above the point of attachment of the pipe. In order to secure the necessary flexibility, the insulator is not attached

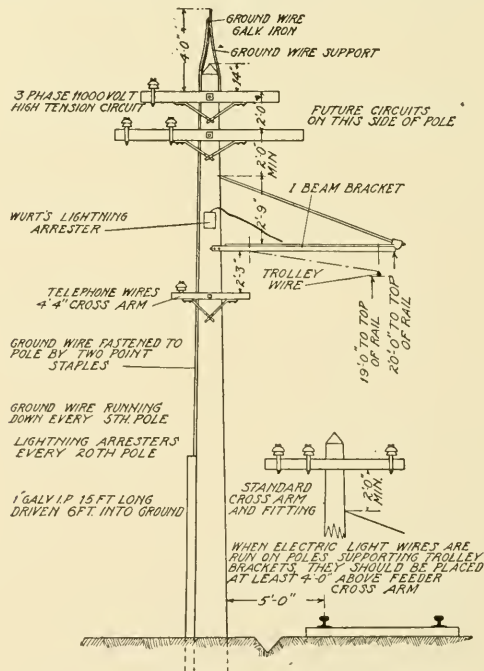

Fig. 197. Catenary Line Construction, Messenger Wire Being Strung on Bracket

directly to the bracket but is hung from a short span wire mounted between the pole and a projection from the outer end of the bracket. A guide piece at the middle of the bracket prevents excessive sag

in the suspension wire. This plan of mounting is shown in Figs. 172, 194, 195, and 196.

In bracket and in span-wire construction, the tension of the wire along the track is not taken up by the hangers, but by diagonal anchor wires which are used at intervals.

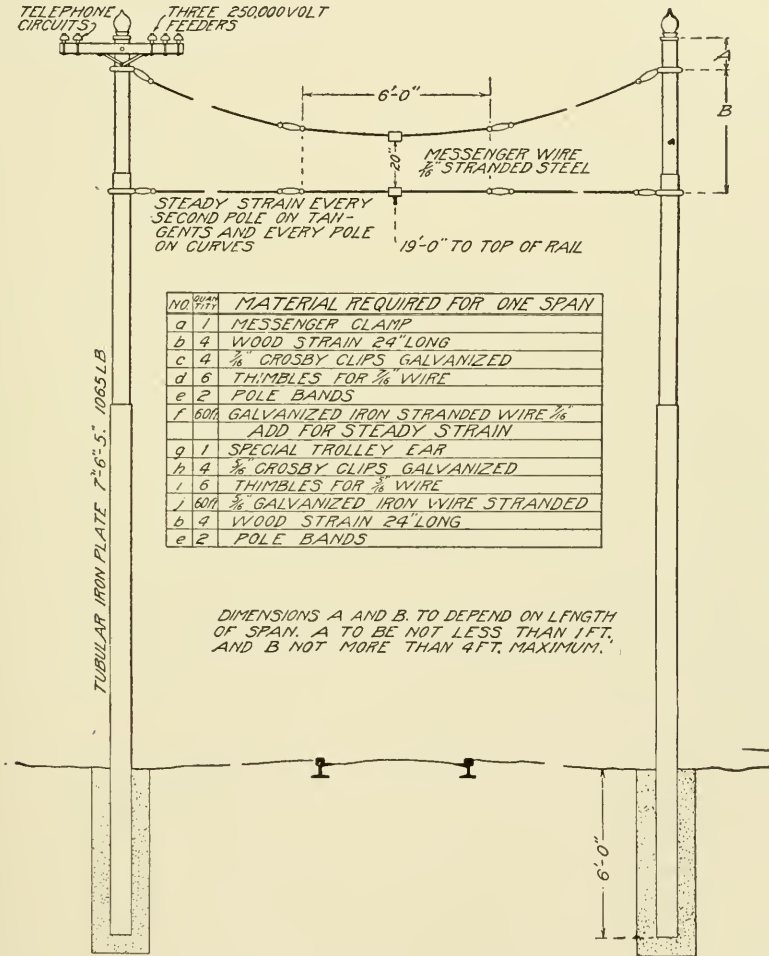

Fig. 198. Span Construction of the Catenary Type

Catenary Construction. The ordinary span wire and bracket construction already described supports the wire at points 100 feet more or less apart and between the points of support, the wire sags

considerably. This is very objectionable in high speed work as the trolley wheel strikes the wire a hard blow at each point of support. With the pantograph trolley used in alternating-current roads, it would be practically impossible to operate with the ordinary construction.

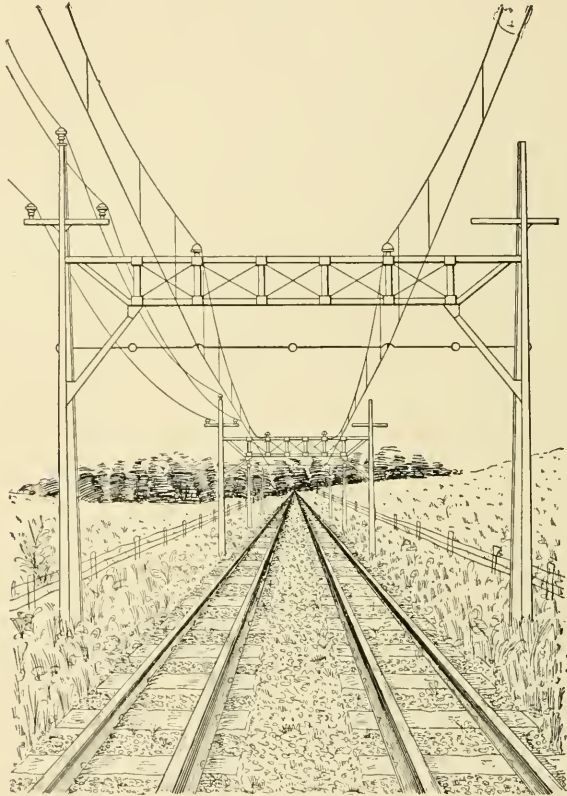

Fig. 199. Catenary System on Light Brace Construction

The catenary trolley-wire support has been developed to overcome this difficulty. As mentioned briefly before this system comprises a steel messenger wire securely mounted on insulators. From the messenger wire, the trolley wire hangs by hangers located at intervals along the messenger wire. There may be any number of these hangers for each span of the messenger wire giving 3-point suspension, 5-point suspension, etc. By using hangers of different lengths a trolley wire may be perfectly straight.

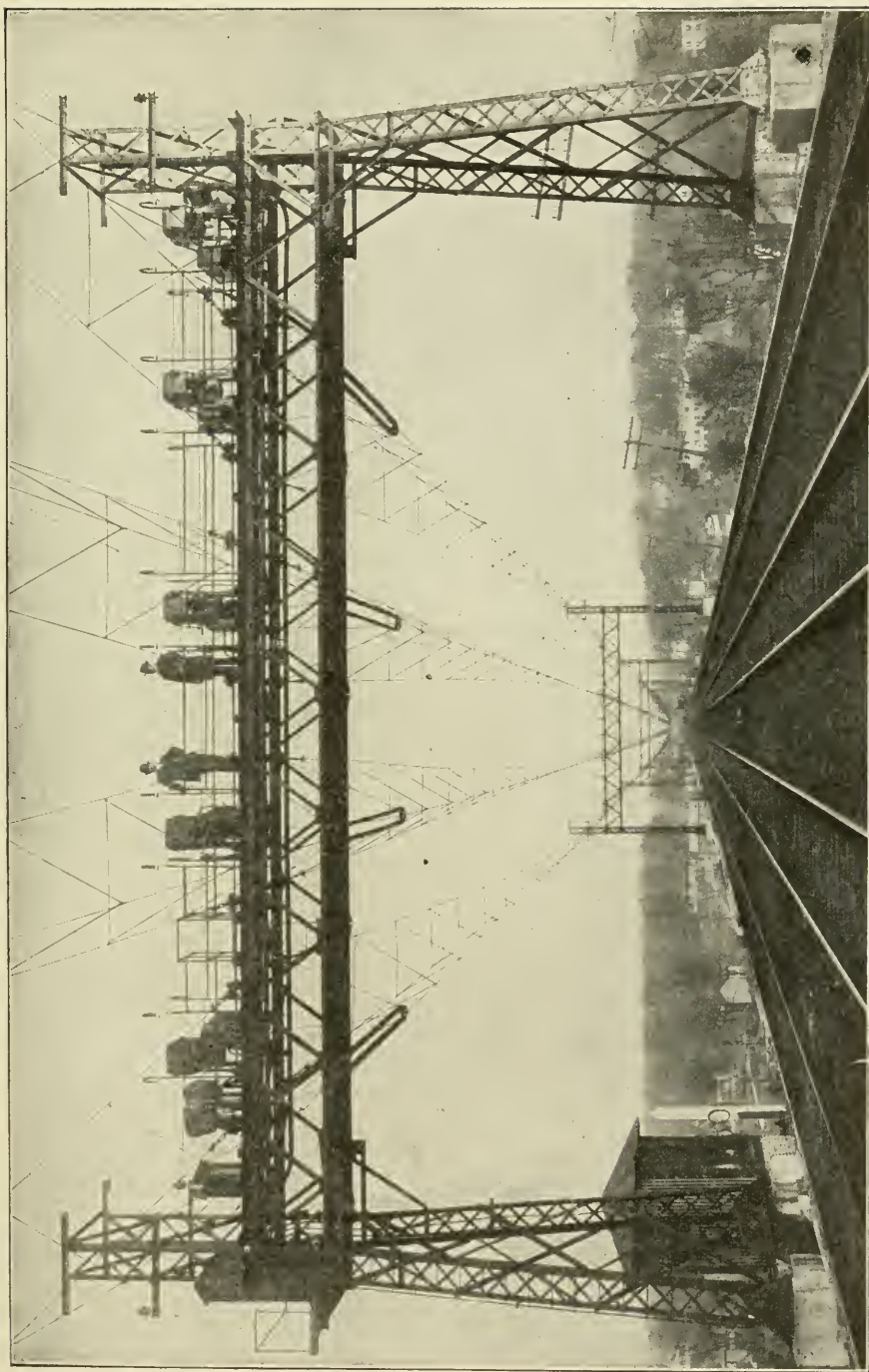

Fig. 200. Double Catenary Trolley Construction on New York, New Haven & Hartford Railroad

The insulators for the messenger wire may be mounted on brackets, on span wires or on light bridge construction. All of these forms of support are illustrated in Figs. 197, 198, and 199.

Where sidewise stiffness is required, two messenger wires may be used with hangers from each to the points of support of the trolley wire, Fig. 200. This is known as double catenary construction.

THIRD-RAIL CONSTRUCTION

The overhead trolley wire is not suitable for the transmission of large currents to the cars as it is difficult to conduct such currents through the small contact surface of trolley wheels. In such cases as require more than a very few hundred amperes, the distribution is through a steel conductor rail mounted alongside the track. The current is taken off through sliding shoes.

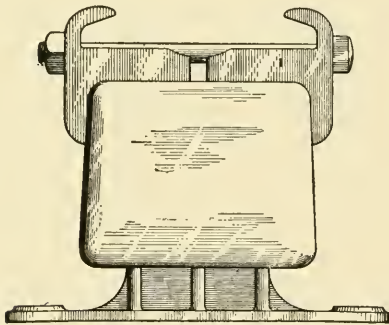

Fig. 201. Third-Rail Insulator

Third-Rail Supports. The conductor rail or "third rail" is mounted either in the usual position, base below and head above, or inverted. Ordinarily the rail used is the standard T-rail section and it may be of the same composition as the standard rails, but should preferably be made of soft steel of high electrical conductivity. Parshall gives a value of about $\frac{1}{3}$

ohm per square-inch-mile—a rod 1 square inch in cross-section, 1 mile long—as an average for good conductor rails. The wearing quality of the rails is not as important as the conductivity, as any rail is durable enough from the standpoint of wear. The weight of the rail per yard* varies from 40 to about 80 pounds.

The conductor rail is supported on insulators which combine good mechanical strength with good insulating properties. These requirements necessitate the use of iron for mechanical strength and porcelain or hard insulating composition for dielectric strength. A sample insulator, shown in Fig. 201, consists of an iron base

*Rails are rated by the weight per yard. It is convenient to remember that the weight per yard is approximately equal numerically to 10 times the cross-section in square inches. A cubic inch of steel weighs about 0.28 pound.

with holes to permit screwing to the tie. (The insulator is placed near the end of the tie outside the rails.) On the base is a block of moulded insulating material—in this case vitrified clay—on top of which is an iron clamp which holds the base of the rail firmly. The weight of the rail helps to hold it in position and the pressure of the contact shoe being downward, there is not much side strain on the rail. An insulator for an inverted rail is shown in detail in Fig. 202. Fig. 203 shows the insulator and bracket in position on the tie.

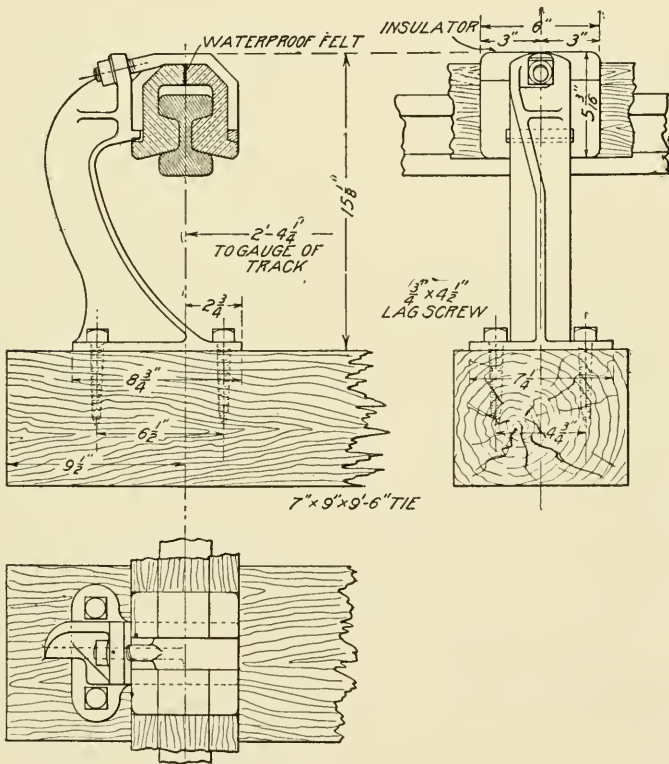

Fig. 202. Details of Insulator and Bracket for Inverted Rail

Protection. The third rail is, in many cases, protected by wood coverings. These prevent accidental contact with the rails by human beings and lower animals, and also protect the rail from short-circuits with the track. The covering is carried upon the rail supports.

Bonding. The lengths of conductor rail are electrically connected by copper bonds which are riveted or brazed to the ends. These bonds are similar to those used on the track which serves as the return conductor.

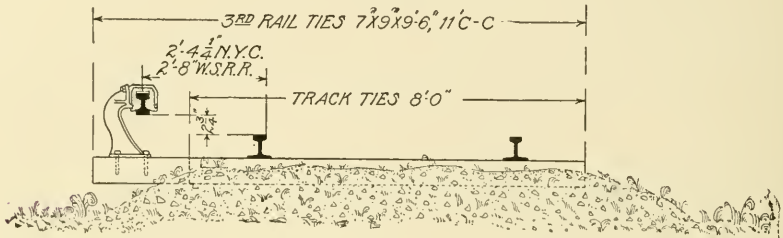

Fig. 203. Inverted Rail Insulator Mounted on Tie

TRACK AS RETURN CIRCUIT

When the track rails are used as the conductors, as is usually the case, it is necessary to see that the electrical conductivity of the rail joints does not offer too high a resistance to the passage of the current. For this reason, when bolts or angle-bar joints are used, the rails are bonded together by means of copper bonds. The resistance of a steel rail, such as used in city streets, is about eleven times that of copper. In order to secure as great a carrying capacity at the rail joint as is afforded by the unbroken rail, it is, therefore, theoretically necessary to install bonds having a total cross-section $\frac{1}{11}$ that of the rail. In practice the cross-section of copper used is much less than this.

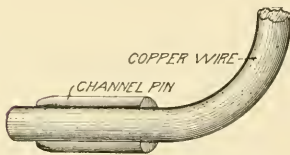

Fig. 204. Channel Pins Used for Bonding

Bonding Systems. The requirements in a bond are that it must make good contact with the rail and that this contact must remain good in spite of vibration and atmospheric conditions. It must allow for the expansion and contraction of the track. Furthermore it

must contain no more copper than is necessary as copper is an expensive metal. Its electrical resistance, also, must be reasonably low. A great many schemes have been devised to insure good and permanent contact between the copper bond and the rail, as the terminal is the weak point in any bond. One of the earliest

and most efficient of small bonds was made by the use of channel pins, Fig. 204. This bond consisted of a piece of copper wire having its ends placed in holes in the rail web near the end of the rail. Alongside this wire, a channel pin was driven in. The objection to the channel pin was the small area of contact between the copper bond and rail.

Next after the channel pin came the Chicago type of bond, Fig. 205, which is a piece of heavy copper wire with thimbles forged on the ends. These thimbles are placed in accurately-fitted holes in the rail ends, and a wedge-shaped steel pin was driven into the thimbles to expand them tightly into the hole in the rail. Several other bonds using modifications of this principle are in use.

A type of bond in very common use consists of solid copper rivet-shaped terminals, Fig. 206, between which is a piece of flexible stranded copper cable, made flat to go under the angle bars. A bond such as this is called a "protected" bond because it is pro-

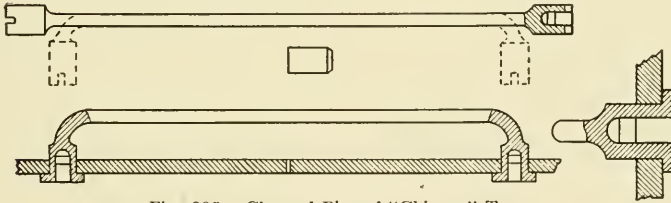

Fig. 205. Channel Pins of "Chicago" Type

tected by the angle bars. In one type the terminal lugs are cast around the ends of the cables, and in another type the cables are forged at their ends into solid rivet-like terminals. These terminal rivets were first applied as any other rivets, with the use of a riveting hammer. Because of the difficulty of thoroughly expanding such large rivets into the holes made for them in the rails, it has become customary to compress these rivets either with a screw press or a portable hydraulic press, which brings such great pressure to bear on the opposite ends of the rivet that it is forced to expand itself so as to fill the hole in the rail completely. This expansion is made possible by the ductile character of the copper. This great ductility characteristic of copper, however, has been the source of one of the difficulties in connection with rail bonding, because the soft copper terminal has a tendency to work loose in the hole made for it in the

rail. It is practically impossible to maintain good bonding where the rail joints are so loose as to allow considerable motion between the rail ends.

Another method of expanding bond terminals into the holes made to receive them is that employed in the General Electric Company's bond. In it a soft pin in the center of the terminal is expanded by compression of the terminal so that it forces the copper surrounding it outward. The copper terminal, in expanding to fill the hole is, therefore, backed by the steel center pin.

The progress which has been made in the past few years in soldering and brazing bonds to rails now makes it possible to use short flat strip bonds soldered or brazed to the web or the base of the rail. These bonds are made of a number of thin sheets piled together (laminated). They are usually corrugated crosswise so that they can be stretched or compressed slightly without undue strain on the terminals. These bonds may be applied by means of any source of fairly intense heat. A very convenient device is an electric welder.



Fig. 206. Flexible Copper Bond

The *plastic* rail bond, so called because it depends for the contact between the rail and the bond upon a plastic, putty-like alloy of mercury and some other metal, is applied in a number of different ways. One form consists of a strip of copper held by a spring against the rail ends under the fish-plate. The rail ends at the point of contact with this strip of copper are amalgamated and made bright by the use of a mercury compound similar to the plastic alloy. These points of contact are then daubed with plastic alloy, and the copper bond plate applied. It is not necessary, with any form of plastic bond, that the mechanical contact be unyielding, as the amalgamated surfaces with the aid of the plastic alloy between them maintain a good conductivity in spite of any slight motion. The plastic alloy can be applied in a number of other ways, one of which is to drill a hole forming a small cup in the rail base in adjacent rail ends, fill these cups with plastic alloy, and bridge the space between them with a short copper bond having its ends projecting down into the cups.

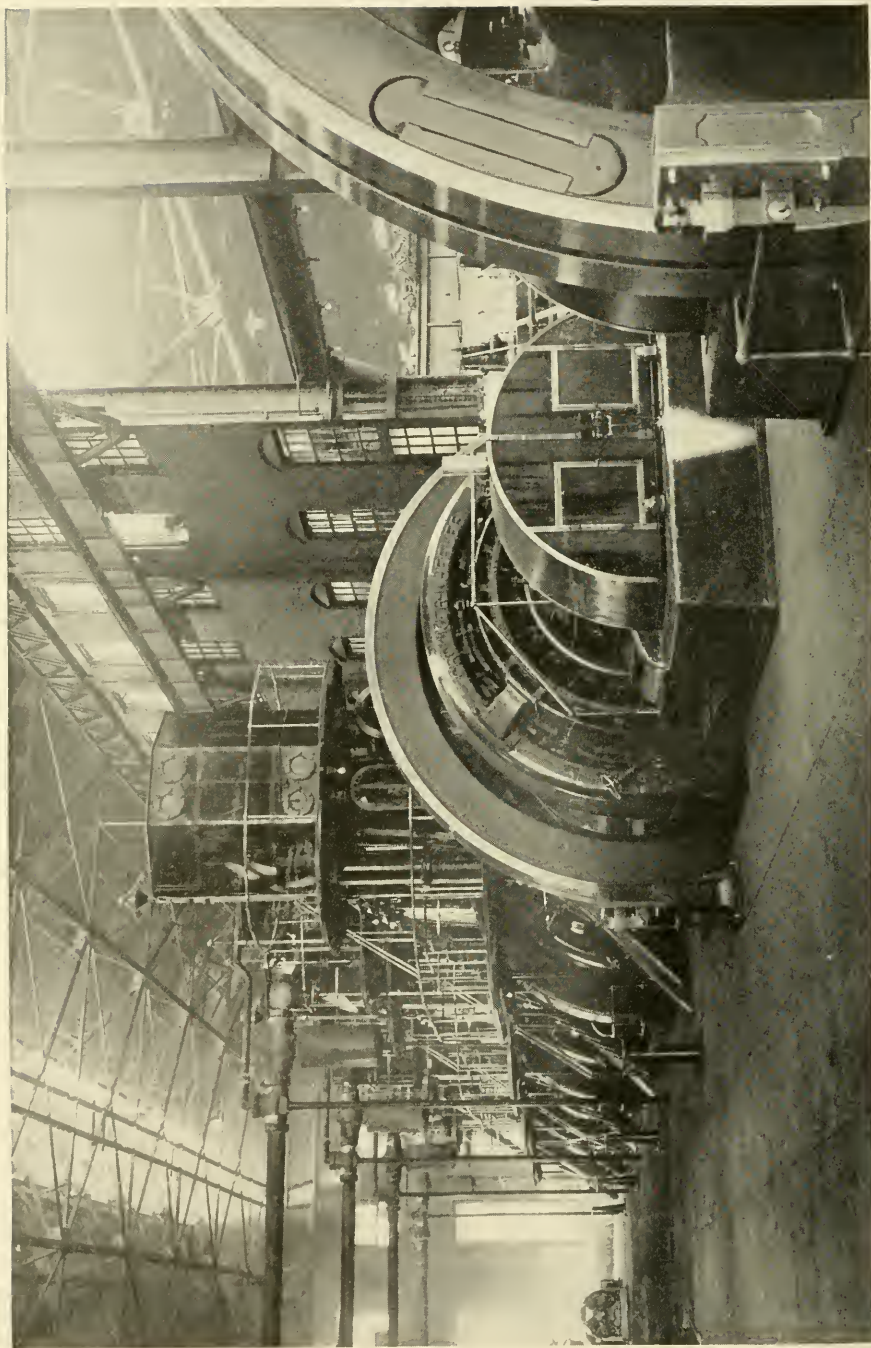

TWO 1000-K.W. AND FOUR 600-K.W. 260-VOLT DIRECT-CURRENT GENERATORS

Courtesy of Crocker-Wheeler Company

All types of bonds must be installed with great care if they are to be efficient. Unless the bond terminal thoroughly fills the hole and is tightly expanded into it, moisture will creep into the space between the copper and the iron, and the copper will become coated with a non-conducting scale which destroys the conductivity of the contact.

Resistance of the Track. The resistance of the return circuit is sometimes much higher than it should be owing to the poor contact of the bonds. The resistance of rails varies greatly with the proportions of carbon, manganese, and phosphorus. The following figures, however, may be regarded as average values for the rail alone.

Weight per Yard	Resistance Single Rail per Mile
50	.095 ohm
60	.079 ohm
70	.063 ohm
80	.059 ohm
90	.053 ohm

A single track laid with continuous rails would have one-half the resistance given, since there are two rails in parallel.

A bond may be considered good when the bond and 1 foot of the rail over it have a resistance equal to 5 feet of the solid rail. The theoretically perfect bond, as previously explained, would be equal in conductivity to the rail, but such a bond would be too expensive.

Example. What is the track resistance of a double-track road 10 miles long, laid with 70-pound, 30-foot rails and bonded so that each bond and the foot of rail between its terminals has the same resistance as 5 feet of rail?

SOLUTION. As there are four rails in parallel, the resistance per mile is one-fourth of the value given in the table. There is one bond in each rail every 30 feet and this adds 4 feet of rail as far as the resistance is concerned. The resistance of a mile is, therefore, increased in the ratio of 34 to 30. The track resistance is, therefore,

$$R = 10 \times \frac{34}{30} \times \frac{.063}{4} = .178 \text{ ohm}$$

Bond Testing. It is important to test the conductivity of rail bonds from time to time in order to determine if they have de-

teriorated so as to reduce their conductivity and introduce an unnecessary amount of resistance into the return circuits. One way of doing this is to measure the drop in voltage over a bonded joint as compared with the drop in an equal length of unbroken rail. To do this, an apparatus is employed whereby simultaneous contact will be made bridging three or more feet of rail and an equal length of rail including the bonded joint, as shown in Fig. 207, which illustrates the connections of a common form of apparatus where two milli-voltmeters are employed to measure the drop in voltage of the bonded and unbonded rail simultaneously. If the current flowing through the rail due to the operation of the cars were constant, one milli-voltmeter might be used, connected first to one circuit and then to the other. The current in the rail, however, fluctuates rapidly, so that two instruments are necessary for rapid

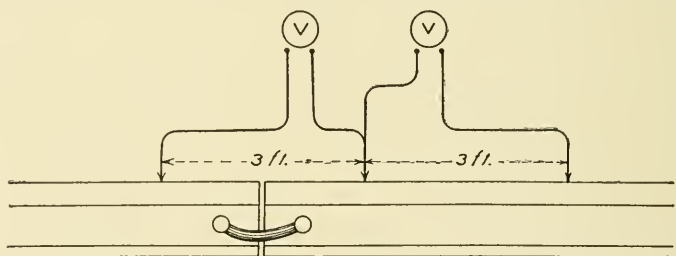

Fig. 207. Common Form of Bonded Joint with Milli-Voltmeters Attached to Show Voltage Drop

work. The resistance of the bonded joint is usually considerably more than that of the unbroken rail, and the milli-voltmeter used to bridge the joint consequently need not be so sensitive as that bridging the unbroken rail.

In another form of apparatus, a telephone receiver is used instead of the milli-voltmeter, the resistance of a long unbroken rail being balanced against that of the bonded joint, as in a Wheatstone bridge, until, upon closing the circuit, these two resistances when balanced give no sound in the telephone receiver.

Bond tests of the above kinds can be made with satisfaction only when a considerable volume of current is flowing through the rails at the time of the test, because the drop in voltage is dependent on the current flowing, and in any event is small. It has sometimes been found necessary or advisable to fit up a testing car equipped

with a rheostat which will itself use a large current, so as to give a current in the rail which will give an appreciable drop of potential across a bonded joint. Some of the latest forms of testing cars carry motor-generators which pass large currents of known values through bonded joints, and so cause drops across the joints large enough to be easily measured.

Supplementary Return Conductors. On some large roads it is necessary to run additional return feeders from the power house to various points on the system, to supplement the conductivity of the rails. Otherwise the track rails near the power house would have to carry all the current, and in some cases there are not enough such lines of track passing the power house to do this properly. Sometimes these feeders are laid underground in troughs, sometimes bare in the ground, and sometimes they are on overhead pole lines.

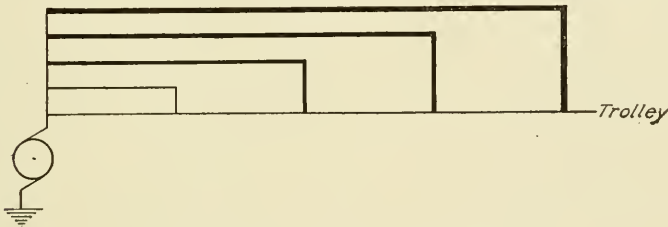

Fig. 208. Diagram of Trolley Feeder System

When the return feeder is laid in the ground, old rails may be used instead of copper or aluminum cables, the rails being thoroughly bonded to give a conductivity nearly equal to that of the unbroken rail.

FEEDER SYSTEMS

There are two general schemes of direct-current feeding in common use. One of these is shown in Fig. 208. Here the trolley wire is continuous and is fed into at different points. The long feeders supplying the more distant portion of the road are larger than those supplying the trolley near by, so as to maintain as nearly as is feasible the same voltage the entire length of the line. The plan shown results in a higher voltage near the power station than at distant points but the distribution of voltage is better than if the heaviest feeders were feeding into the trolley near the power house. In the other plan, shown in Fig. 209, the trolley wire is divided into sections and each

is fed through a separate feeder which is of such size as to maintain the same voltage on all the sections with the ordinary load.

Feeder Calculations. In estimating the proper sizes of wire for a feeder system, probable loads are assumed at certain points along the line. These will depend on the size and number of cars in operation, grades, and many local conditions.

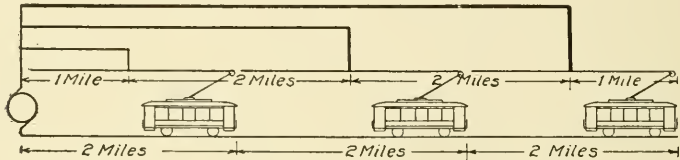

Fig. 209. Feeder System Using Separate Trolley Sections

For example, assume that three cars are placed, as shown in Fig. 209, each at the end of a feeder section and that each is drawing 50 amperes. The line voltage is 600 and the allowable drop in feeders, trolley, and return circuit will be placed at 10 per cent, or 60 volts. The track is single and laid with rails weighing 70 pounds to the yard. The trolley wire is No. 00. The lengths of the sections are as given in the figure.

As the sizes of trolley wire and rails are given, the drops in these must be calculated first and the remainder of the allowable drop will be that which may occur in the feeder. The current in each trolley wire is 50 amperes and from wire tables a mile of No. 00 wire will cause a drop of 20.5 volts with 50 amperes. The current in the two miles of track nearest the power house is 150 amperes, in the next section 100 amperes, and in the last section, 50 amperes. The corresponding voltage drops are calculated from these currents and the resistances of the track sections. A 70-pound rail has a resistance of .063 ohm per mile, Table IV. As explained before this may be increased in the proportion of 34:30 to allow for bonding; and as there are two rails in parallel, the rail and bond resistance must be divided by 2. The track resistance of each 2-mile section is, therefore, 0.0715 ohm. The drop in the first section (nearest the power house) is $150 \times 0.0715 = 10.72$ volts; that in the second section is $100 \times 0.0715 = 7.15$ volts; and that in the third section is $50 \times 0.0715 = 3.57$ volts. The track drop from the power house in each case is obtained by adding together the individual

TABLE IV
Rail Resistance Data

Drop in track section, volts	10.72	7.15	3.57
Total drop in track, volts	10.7	17.9	21.5
Drop in trolley wire, volts	20.5	20.5	20.5
Total drop in track and trolley wire, volts	31.2	31.2	31.2
Allowable drop in feeder, volts	28.8	21.6	18.0
Resistance feeder, ohms	0.576	0.432	0.36
Feeder resistance, ohms per mile	0.576	0.144	0.072
Nearest (larger) size of wire from wire tables	0	400,000 c.m.	750,000 c.m.

drops. Hence, the drop to the end of section 1 is 10.7 volts; to the end of section 2, 17.9 volts; and to the end of section 3, 21.5 volts.

As we have allowed a total drop of 60 volts at each car in the positions shown, we may now obtain the allowable drop in each feeder by subtracting from 60 volts the calculated drop in trolley and track in each case. Then, by dividing the drop by the corresponding current, the total resistance of each feeder is determined. Dividing this value by the length of the feeder gives the resistance per mile or per thousand feet and the corresponding size can be read directly from a wire table. After doing this there result the values shown in Table IV.

STRAY CURRENTS FROM ELECTRIC RAILWAYS

Electrolytic Currents. Much has been said about the possibilities of electrolysis of underground metal by the action of return currents of electric railways, when operated as they usually are with grounded circuits. If electric current is passed through a liquid from one metal electrode to another, electrolysis will take place; that is, metal will be deposited on the negative pole, and the positive pole or electrode will be dissolved by becoming oxidized from the action of the oxygen collecting at that pole.

In an electric-railway return circuit, there is necessarily a difference of potential between the rails in outlying parts of the system and the rails and other buried pieces of metal located near the power house. The value of this difference of potential depends on the loss of voltage in the return circuit. Thus, suppose there is a drop

of 25 volts in the return circuit between a certain point on the system and the power station. There is, therefore, a pressure of 25 volts tending to force the current through the moist earth from the rails at distant portions of the line, to the rails, water pipes, and other connected metallic bodies located in the earth near the power station. The value of the current that will thus flow to earth in preference to remaining in the rails depends on the relative resistance of the rails, the earth, and the other paths offered to the current to return to the power house.

To take a very simple case, let us suppose a single-track road, Fig. 210, with a power house at one end, and a parallel line of water pipe on the same street passing the power house. If the positive terminals of the generators are connected to the trolley wire, the current passes, as indicated by the arrows, out over the trolley wire through the cars and to the rails. When it has reached the rails

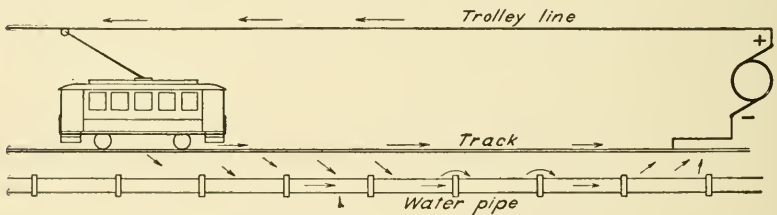

Fig. 210. Diagram Showing Stray Current to Water Pipe

it has the choice of two paths back to the power house. One is through the rails and bonding; the other is through the moist earth to the line of water pipe and back to the power house, leaving the pipe for the rails, at the power house. Should the bonding of the rails be very defective, considerable current might pass through the earth to the water pipe.

From the principles of electrolysis, we see that the oxidizing action of this flow of current from the rails to the water pipes at the distant portion of the road will tend to destroy the rails, but will not harm the water pipe at that point, as it will tend to deposit metal upon it. When, however, the current arrives at the power house, it must in some way leave this water pipe to get back to the rails, and so to the negative terminals of the generators. There is thus a chance for corrosion of the water pipe, because at this point it forms the positive electrode, which is the one likely to be

oxidized and destroyed. This very simple case is taken merely for illustration. In actual practice the conditions are never so simple as this, for there are various pipes located in the ground running in various directions, which complicate the case very much; but we can see from this simple example that the points at which corrosion of water pipe is to be expected are those where large volumes of current leave the pipe to reach some other conductor.

As an indication of how much current is likely to be leaving the water pipes at various points, it is customary to measure the voltage between the water pipes and the electric railway track and rails. When this voltage is high, it does not necessarily mean that a large volume of current is leaving the water pipes at the point where these pipes are several volts positive with reference to the rails; but such voltage readings indicate that, if there is a path of sufficiently low resistance through the earth, and if the moisture in the earth is sufficiently impregnated with salts or acids, there will be trouble from electrolytic action due to a large flow of current. There is no method of measuring exactly the amount of current leaving a water pipe at any given point, since the pipe is buried in the earth. Voltmeter readings between pipes and rails simply serve to give an indication as to where there is likely to be trouble from electrolysis. The danger to underground pipes and other metallic bodies from electrolysis has been much over-estimated by some people, as the trouble can be overcome by proper care and attention to the return circuit. Trouble from electrolysis, however, is sure to occur unless such care is given.

Prevention of Electrolysis. Remedies for electrolysis may be classified under two heads—general and specific. The general remedy is to make the resistance of the circuit through the rails and supplementary return feeders so low that there will be but little tendency for the current to seek other conductors, such as water and gas pipes and the lead covering of underground cables. This remedy consists in heavy bonding, in ample connections around switches and special work where the bonding is especially liable to injury, and in additional return conductors at points near the power house to supplement the conductivity of the rails. It is important that all rail bonds be tested at intervals of six months to one year in order that defective bonds may be located and renewed, as a few

defective bonds can greatly lower the efficiency of an otherwise low-resistance circuit.

The specific remedy for electrolysis which may be applied to reduce electrolytic action at certain specific points, consists in connecting the water pipe at the point where electrolysis is taking place, with the rail or other conductor to which the current is flowing. Thus, for example, if it is found that a large amount of current is leaving a water pipe and flowing to the rails or to the negative return feeders at the power house, the electrolytic action at this point can be stopped by connecting the water pipe with the rails by means of a low-resistance copper wire or cable, thereby short-circuiting the points between which electrolytic action is taking place. There are certain cases in which it is advisable to adopt such a specific remedy. It should be remembered, however, that a low-resistance connection of this kind, while it reduces electrolysis at points near the power house, is an added inducement to the current to enter the water pipes at points distant from the power house. This follows because the resistance of the water-pipe path to the power house is decreased by the introduction of the connection between the water pipe and the negative return feeder at the power house. With the water pipes connected to the return feeders in the vicinity of the power house, the current which flows from the rails to the water pipes at points distant from the power house will cause electrolysis of the rails but not of the water pipes, since the current is passing from the earth to the pipe, the pipe being negative to the earth. In this case the principal danger is that the high resistance of the joints between the lengths of water pipe will cause current to flow through the earth around each joint, as indicated on some of the joints, Fig. 210, and thus produce electrolytic action at each joint. It is evident, however, that the conditions of the track circuit and bonding must be very bad if current would flow over a line of water pipe, with its high-resistance joints, in sufficient volume to cause electrolysis, in preference to the rail-return circuit, especially since ordinarily the resistance offered to the flow of current over the water pipes back to the power house must include the resistance of the earth between the tracks and water pipes. It is usually considered inadvisable to connect tracks and water pipes at points distant from the power house, because of danger of electrolysis at pipe joints.

SIGNAL SYSTEMS

In connection with the operation of electric railways, safety to passengers and equipment is a prime consideration. In the operation of high-speed interurban railways, particularly in the case of single-track roads, there is great danger of collision and damage unless provision is made for giving the train crews reliable information regarding the location of other cars on the same track and in the neighborhood.

Dispatcher. Cars are operated upon a regular schedule which provides for the safe operation of the road if all cars are strictly on time and if there are no extra or special cars on the line. The lat-

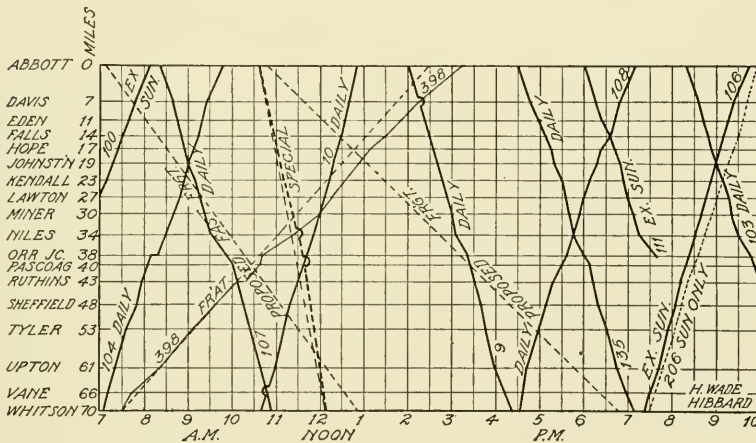

Fig. 211. Railway Train Sheet

ter are a great source of danger unless their location is known to the crews of all cars which might possibly collide with them.

The duty of the dispatcher in a railway system is to so regulate the movements of the cars that safety will result. He will be assisted by the use of some sort of a graphical time table or train sheet such as is shown in Fig. 211. This is laid out with the time as the base and the position of the cars as the vertical scale of the diagram. A diagonal line on the diagram drawn at such an angle as to correspond with the average speed will show at each instant the approximate position of the car. Any number of regular and special cars can be followed in this way. This graphical time-

table can also be made by means of a board supplied with pegs at the beginning and end of the runs and strings connecting them. Such a diagram can be readily changed. The intersections of the lines of opposite slope show the passing points and the corresponding times. This is a matter of great importance in the case of a single-track road.

In addition to the time-table it is necessary for some means to be provided whereby the train crews can get into touch with the dispatcher, to learn of special orders, especially if the cars are off schedule. Telephones located at convenient points, such as turn-outs answer this purpose. These allow the crews to call up the dispatcher but do not permit the dispatcher to call the crews. With

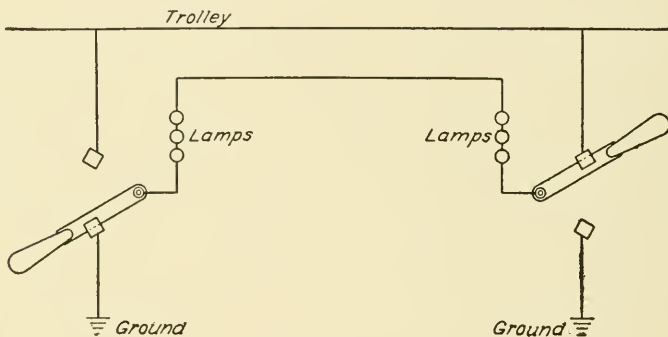

Fig. 212. Hand-Operated Block System

a simple telephone system it is, therefore, necessary to have very strict rules regarding the calling up of the dispatcher in case of any doubt. In addition to the telephone system it is desirable to have some kind of signals which can be set by the dispatcher to call the crews to the telephone. Progress is being made in this direction.

Block Signals. For some time the steam railways have used the "block" plan of operation, the road being divided into signal sections, or "blocks." A block is a section protected at the ends by signals indicating whether or not a train is in it. These signals may be set by hand or they may be automatic, that is, set by the trains. Signals for steam railways have been brought to a high state of perfection. They are very expensive and the cost of a system such as is used on a steam railway would be prohibitive for electric railways in most parts of the country. At the same time simple block

signal systems are being installed on a number of roads, which indicates that the difficulties met with in producing a simple, cheap and effective signal are being overcome. Some of the elements of

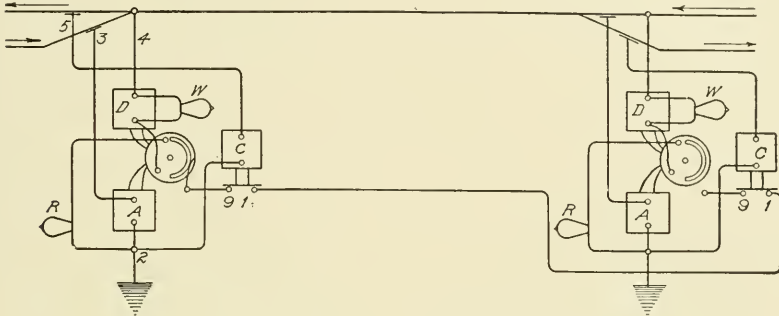

Fig. 213. Diagram of Automatic Block Signal System

these systems will be described. It should be remembered, however, that the art is in a state of development at present and practice cannot be considered as standardized.

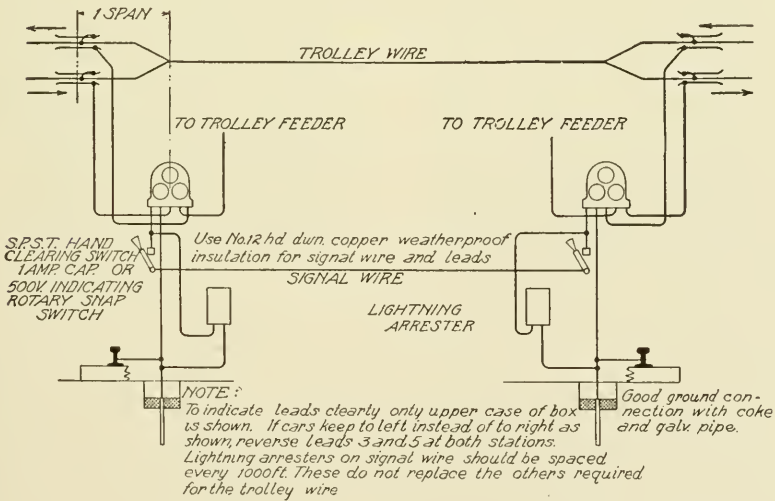

Fig. 214. Diagram of Automatic Block Signal System

Hand-Operated. The simplest block signal used by electric roads is a hand-operated one constructed on the principle shown in the diagram, Fig. 212. At each end of the block a bank of lamps is

located to indicate whether or not the block is clear. The lamps are placed in a weatherproof box with a glass window. Red glass is sometimes used to suggest danger. A double-throw switch is connected with the lamps at each terminal of the section, as shown in the figure. The switches have no central position, the knife blade always making contact with one or the other of the terminals shown. If the lamps are lighted, throwing either one of the switches will put them out and if they are not burning, they will be lighted by throw-



Fig. 215. Signal Box—White Disk Displayed

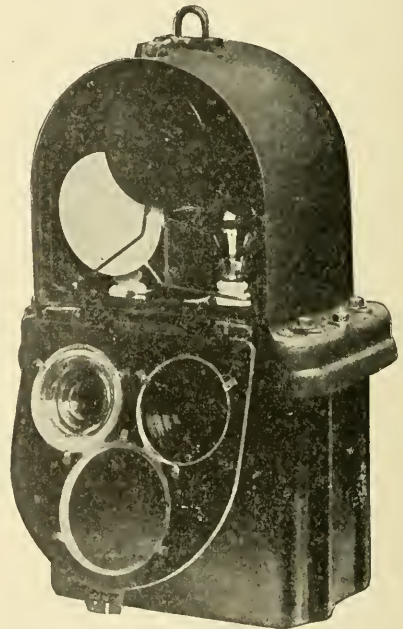

Fig. 216. Signal Box with Front Cover Down

ing either one of the switches. A motorman on reaching a section of track, finding the lamps not burning, throws the switch. Lamps now burn in each switch box and show that the section is in use. On arriving at the other terminal of the block the switch is thrown, extinguishing the lights and showing that the block is clear.

Automatic. The crude arrangement described above is only suitable for use in roads with low-speed schedules. It fails to indicate in which direction the car in the block is going and it depends upon the reliability of the train crews in operating it. An automatic

system of some kind is, therefore, desirable if it meets the specifications mentioned above. Figs. 213 and 214 show diagrammatically one of the simple systems which has been developed. The essential features of this are (1) a signal box with red and white lights, located at each end of a block, provided with corresponding red and white semaphore disks; (2) a set of trolley switches by means of which the signal boxes are automatically operated. The signal box is shown in Figs. 215, 216, and 217. The upper part contains the lamps and the red and white "bull's-eyes," and the red and white semaphore disks which are displayed through the circular opening. In the lower part of the box, submerged in oil, are the relays, or magnets, by which the semaphore disks are moved and the electric circuits are controlled. The trolley switch, shown in Figs. 218, 219, and 220, consists of a light angle-iron frame hung from an insulated hanger and carrying blocks of insulating material on which are mounted the contact strips. The trolley wheel connects these strips with the trolley wire and from the contact strips wires lead to the relays.

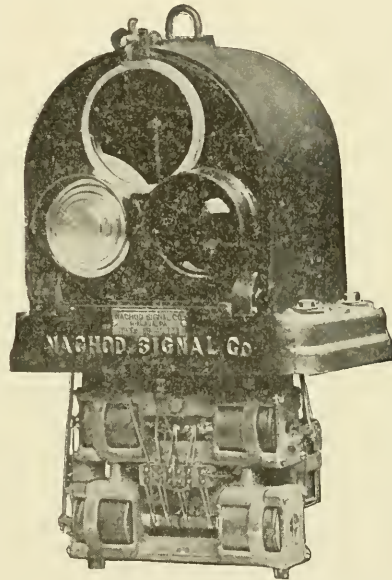

Fig. 217. Box Showing Operating Mechanism

Before taking up the details, attention is called to the purposes which the device is designed to accomplish. Before a car enters a block the motorman wishes to know if there is a car in the block and if so in what direction it is going. The signal system is planned to indicate these two items. When there is no car in the block there is no light in either signal box and the semaphore disks are down. When a car enters the block a white light and a white disk are displayed at the entering end and a red light and a red disk at the leaving end. The white light and semaphore show that another car may enter the block but must proceed carefully because there is a car ahead. If on approaching a block a white light is seen, indicating

the presence of one or more cars in the block and moving in the same direction as the entering car, the motorman looks for a blinking of the white light as he passes the signal box. This indicates that



Fig. 218. Block Switch Showing Side Construction

there is not an excessive number of cars in the block. The way in which these features of operation are secured is shown in the diagrams of Figs. 213 and 214.



Fig. 219. Block Switch Showing Under Construction

In Fig. 213 is shown at each end of the block a revolving switch operated by two magnets, *A* and *D*. The core of each magnet carries a pawl which works backward and forward on ratchet wheels, rotating the switch in one direction or the other. The switch carries a semi-circular contact strip which makes contact with the terminals shown. Each signal box contains a circuit breaker *C*, its winding being connected in the circuit of the "leaving" trolley switch *5* in the left-hand station. The operation of the apparatus is as follows: With no car in the block, as shown, the signal wire (the lower one)

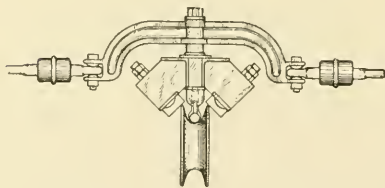

Fig. 220. Section of Block Switch

is grounded through the red lamps. Suppose now that a car enters the block from the left. Trolley switch *3* is closed and energizes magnet *A*, the armature of which rises and rotates the revolving switch in a clockwise direction. This causes the

contact strip to break connection with the upper terminal and to close the connection with the lower one. Current now flows from the trolley wire through wire *4*, through white light *W*, in shunt with which is magnet *D* which is energized and its core lifted through the revolving switch, through contacts *9* and *1* of the circuit breaker *C*,

through the signal wire and the contacts *9* and *1* of the right-hand circuit breaker, through the upper contact of the revolving switch, through the right-hand red lamp to ground.

The trolley wheel of the entering car closes switch *3* for but an instant after which magnet *A* is de-energized and its armature drops back to the off position by gravity. The revolving switch, however, remains in its new position.

When the car leaves the right-hand end of the block its trolley wheel closes the lower trolley switch and energizes the coil of right-hand circuit breaker *C* which opens the signal-wire circuit, de-energizing magnet *D* at the left. The core of magnet *D* drops and the pawl rotates the revolving switch backward by exactly the same amount that it was previously rotated forward and the whole apparatus returns to the original conditions.

Suppose now that several cars are entering the block in the same direction, one after another. As each car closes switch *3*, the revolving switch is rotated through a small angle but no change is made in the electrical circuit. As magnet *A* operates, a resistance (connection not shown) is connected in series with white lamp *A*, thus causing a flicker which indicates that the switch has operated. After a certain number of cars have entered the block, the revolving switch can rotate no farther and magnet *A* cannot operate. As the cars successively leave the block the circuit breaker opens a corresponding number of times and the switch is rotated backward to its original position when all the cars have left the block.

The connections for controlling the semaphore disks are not shown in the diagram. It should be understood that the operation of the lamps and disks is synchronous. The white semaphore is operated by magnet *D* and the red one by a magnet in shunt with the red lamp but not shown in the diagram.

With this explanation of the operation of an automatic system the student will be able to follow the published descriptions of more complicated systems if he has occasion to do so. A number of electric roads have installed systems which use the rails for conducting the signal current. In direct-current railways alternating signal current is used. In alternating-current railways a current of higher frequency than the power current is used for the signals. The short-circuiting of the rails by the wheels and axles operates the signals.

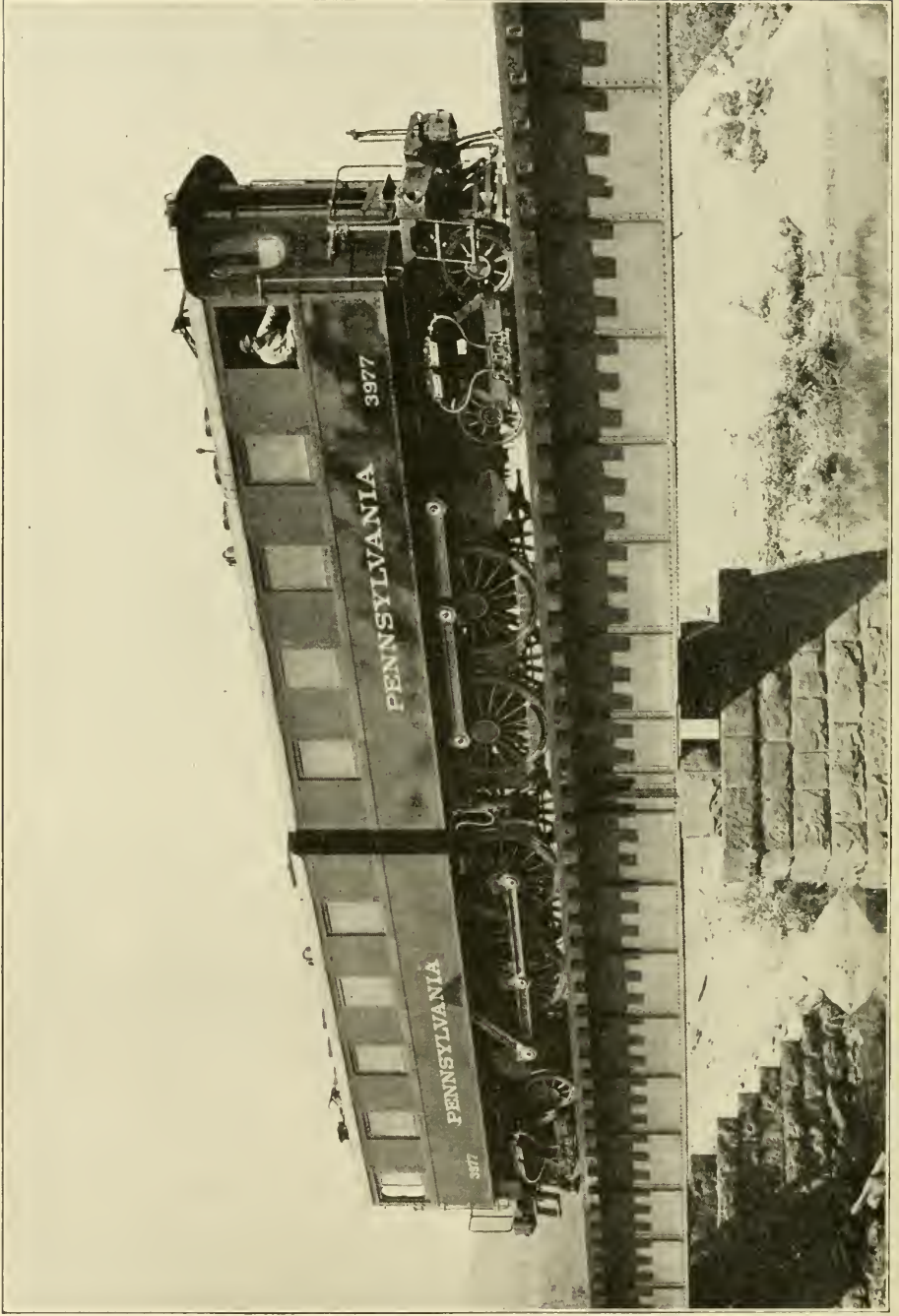

WESTINGHOUSE ELECTRIC LOCOMOTIVE COMPLETE WITH ARTICULATED TRUCK
Courtesy of Westinghouse Electric and Manufacturing Company

ELECTRIC RAILWAYS

PART IV

TRACK CONSTRUCTION

A railway track consists of steel rails securely attached to cross-ties which in turn are placed in a bed of broken stone, gravel, or concrete.

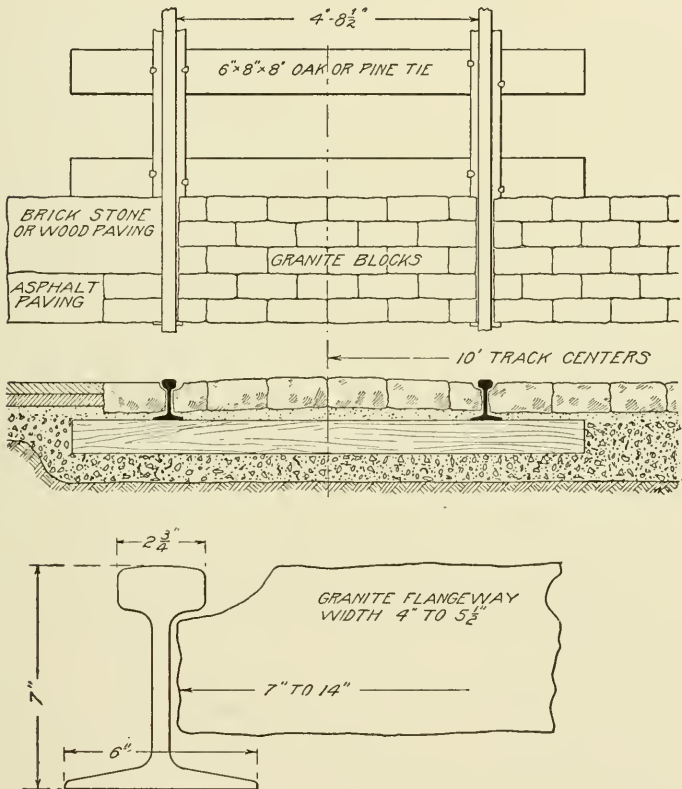

Fig. 221. Plan and Section of Typical City Track

crete. Under the "ballast" or the bed of concrete is a foundation of solid earth or of large stones. A cross-section of a typical city track is shown in Fig. 221 and of an interurban track in Fig. 172, p. 195.

The rail lengths are joined together by some form of joint and where tracks cross or branch, "special work" is put in. "Special work" is a term applied, therefore, to crossings, switches, turnouts, etc.

RAILS

Common T Rail. The T rail used by steam railroads is known as the A. S. C. E. standard T rail, because it follows the standard dimensions recommended for T rails by the American Society of Civil Engineers. A standard 65-pound T rail of this kind is shown in Fig. 222. Other weights of this rail have the same relative proportions. Such a rail is used for interurban electric roads, and for suburban lines in streets where there is no block paving. The rail consists of three parts, the head, the web, and the base. The head is designed to contain enough steel so that it will wear for a reasonable time and the quality of steel is chosen to give the head the necessary wearing qualities. The web gives stiffness to the rail and its thickness and depth are chosen so as to give the proper support to the head. The base, which rests on the ties, is made wide enough to distribute the pressure over as great a tie surface as possible and to

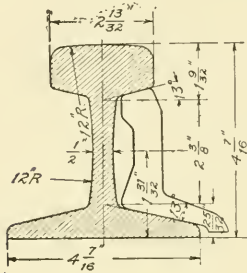

Fig. 222. Section of 65-pound T Rail

give the rail the necessary stability when subjected to side pressure. The base is spiked or bolted to each tie on both sides. Long experience of steam railroads and rail manufacturers has determined the proper proportions, weights, and composition of standard T rails so as to meet the requirements of operation (wearing qualities and stiffness) with a minimum amount of steel per yard.

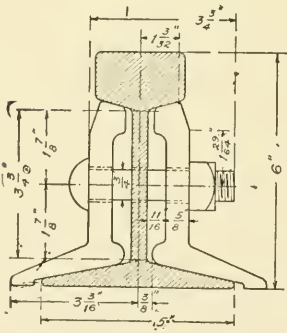

Fig. 223. Shanghai T Rail

223. This rail is tall enough to permit the use of high paving blocks around it.

Girder Rail. In the early days of electric traction the most common form of rail for city use was the "girder," a typical section of which is illustrated in Fig. 224. This is an outgrowth of the old tram rail used on horse railways. It has a flat projection, the tram, alongside the head, on which vehicles may be driven. The flat steel surface makes an excellent rolling surface for wagon and carriage wheels, the gauge of which usually corresponds to that of standard track (4 ft. 8½ in.). Its chief advantage from the standpoint of the railway company is that there is plenty of room for dirt and snow to be pushed away by the flanges of the cars. If the company maintains the paving, it may be to its advantage to have teams use the steel track rather than the paving, although this advantage in maintenance is probably more than counterbalanced by the delay of cars through the regular use of the track by teams.

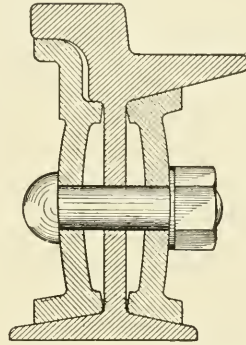

Fig. 224. Girder Rail

"Trilby" or Grooved Rail. A modification of the girder rail, known as the *Trilby*, and sometimes as the *grooved girder*, is shown in Fig. 225. It has a groove of such a shape that the flanges of the car wheels will force snow and dirt out of it instead of packing it into the bottom of the groove, as in the case of the regular European narrow-grooved rail. A narrow-grooved rail in which the grooves correspond closely to the shape of the car-wheel flanges is sure to make trouble in localities where there is snow and ice, as the grooves become packed and derail the cars. A number of varieties of this type of rail are in use. They differ principally in the height of the lip shown at the right in the figure. This may be higher than the head or lower, or it may be, as in the section shown, nearly on the same level.

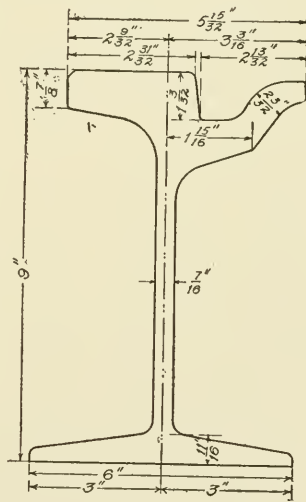

Fig. 225. "Trilby" or Grooved Rail

Guard Rail. On T-rail curves it is customary to use a guard rail which bears against the inside of the wheel flange and assists in holding the wheel to the rail. The guard rail is of a special form as shown in the "mate" in Fig. 236, p. 246. It is bolted to the inside of the rail web. Guard rails may be improvised out of old standard rails bolted to the main rail with spacing blocks between, but the regular sections are to be preferred.

Composition of Rails. As the qualities of steel are very greatly affected by the chemical composition, specifications drawn by railway companies are very rigid in this matter. For rails of average hardness and ductility the following sample specifications may be taken as typical.

Constituent	Percentage present
Carbon.....	0.75 to 0.85, average 0.80
Sulphur, not to exceed.....	0.04
Phosphorus, not to exceed.....	0.03
Silicon, not to exceed.....	0.20
Manganese.....	0.80 to 0.90

Open-hearth steel is being used to an increasing extent with satisfactory results. The standard composition for this steel does not differ substantially from the above except that the percentage of carbon is less—0.60 to 0.75.

Manganese steel is one of the latest developments in steel rails. Manganese steel has been cast for some time but only within the past few years has it been possible to obtain it in the form of rolled rails. The ability of this material to withstand wear is very great—many times that of ordinary steel. The composition is about as follows:

Carbon.....	0.90 to 1.20
Phosphorus.....	not over 0.10
Silicon.....	not over 0.50
MANGANESE.....	9.50 to 16.00
Sulphur.....	not over 0.06

RAIL JOINTS

The ideal track would have continuous rails, but as rails are made in lengths of 30 to 33 feet, or about 60 feet, this ideal condition can be realized only by using joints which give the same effect as a continuous rail. In ordinary track the joints are the weakest part and rails wear out from the hammering effect at loose

joints long before they would if there were no joints. The ordinary joint is made by bolting a pair of angle bars or fish plates to the sides of the rail. Sections through such joints are shown in Figs. 222 and 223. The edges of these bars are made accurately to such an angle that they will wedge in between the head and base of the rail as the bolts are tightened; hence the name *angle bars*. This is the form of joint generally used on steam railroads and on electric roads in exposed track, or in track where the joints are easily accessible, as in dirt streets. In paved streets, the undesirability of tearing up the pavement frequently to tighten the bolts on such joints has led to the invention of several other types, which will be described

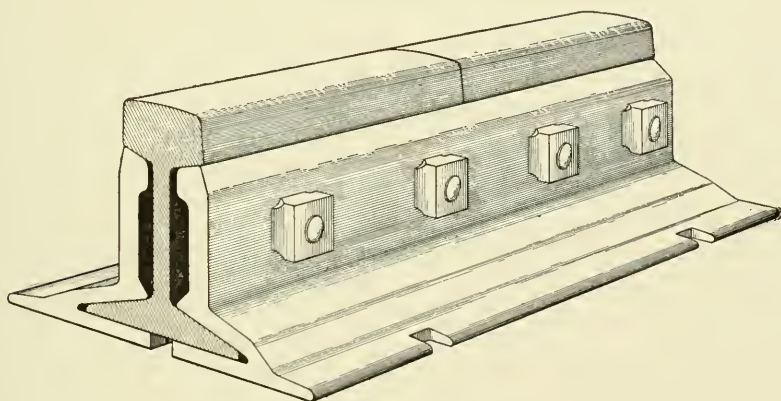

Fig. 226. Continuous Rail Joint

later. Nevertheless very good results have been obtained with bolted joints laid in paved streets where care has been given to details in laying the track, and where the joints have been tightened several times before the paving is finally laid around them.

As the angle bars do not give altogether satisfactory service, particularly in paved streets, as explained above, numerous improved joints have been brought out. The purpose of these is to secure permanence without excessive stiffness. That is the joint is designed to be about as flexible as the continuous part of the rail. Cross-sections of several of these are shown in Figs. 226, 227, and 228. Each of these supports the base of the rails and also produces a wedging effect between the base and the head of the rail. The

“continuous” joint grips the base above and below. The “Weber” joint has a flat base, which is spiked to the tie, in addition to the angle plates. The base plate has a vertical plate projecting from it and this is separated from one of the angle plates by a wooden block

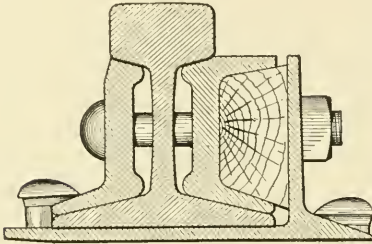

Fig. 227. Weber Joint

or filler for the purpose of utilizing the elasticity of the wood in giving a tight but flexible joint. The “Wolhaupter” joint has a corrugated base plate and the angle bars are so formed as to grip this plate and the base of the rail. The ends of the rails are thus bound together all around.

Welded Joints. Several forms of welded joints are in use. All of these welded joints fasten the ends of the rails together so that the rail is practically continuous—just as if there were no joints—so far as the running surface of the rail is concerned. It was thought at one time that a continuous rail would be an impossibility because of the contraction and expansion of the rail under heat and cold, which, it was thought, would tend to pull the rails apart in cold weather and cause them to bend and buckle out

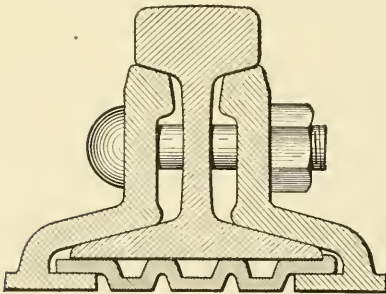

Fig. 228. Wolhaupter Joint

of line in hot weather. Experience has conclusively shown, however, that contraction and expansion are not to be feared when the track is covered with paving material or dirt. The paving tends to hold the track in line, and to protect it from extremes of heat and cold. The reason that contraction and expansion do not work havoc on track with welded

joints is probably that the rails have enough elasticity to provide for the contraction and expansion without breaking. It is found that the best results are secured by welding rail joints during cool weather, so that the effect of contraction in the coldest weather will be minimum. In this case, of course, there will be considerable expansion of the track in the hottest weather, but this does not cause

serious bending of the rails; whereas occasionally, if the track is welded in very hot weather, the contraction in winter will cause the joint to break.

Cast-Welded Joints. The process of cast-welding joints consists in pouring very hot cast iron into a mould placed around the ends of the rails. These moulds are of iron; and to prevent their sticking to the joint when it is cast, they are painted inside with a mixture of linseed oil and graphite. Iron is usually poured so hot that, before it cools, the base of the rail in the center of the molten joint becomes partially melted, thus causing a true union of the steel

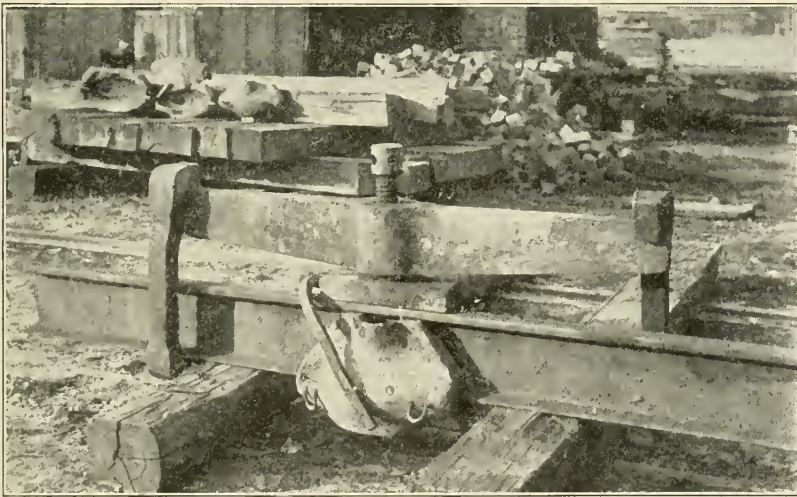

Fig. 229. Apparatus Set for a Cast-Welded Joint

rail and cast-iron joint. This makes the joint mechanically solid and a good electrical conductor. To supply melted cast iron during the process of cast-welding joints on the street, a small portable cupola on wheels is employed. Fig. 229 gives an idea of the process of making cast-welded joints.

Electrically-Welded Joints. An electrically-welded joint is made by welding steel bars to the rail ends. A steel bar like that shown in Fig. 230 is placed on each side of the joint, and current of very large volume is passed through from one block to the other. This current is so large that the electrical resistance between the

rail and steel block causes that point to become molten. Current is then shut off, and the joint allowed to cool. There is in this case a true weld between the steel blocks and the rails and joint. The appearance of a joint is shown in Fig. 231.

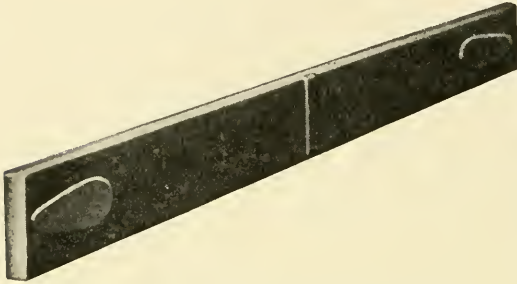

Fig. 230. Steel Bar for Electrically Welded Joint

An electric welding outfit being expensive to maintain and operate, this process is used only where a large amount of welding can be done at once. The direct current is taken from the trolley wire at 500 volts and passed through a rotary converter which converts it into an alternating current. A transformer reduces the voltage and gives a current of great quantity at low voltage, the latter current being passed through the blocks and rails in the welding process. A massive pair of clamps is used to force the blocks against the rails with great pressure, and to conduct the current to and from the joint while it is being welded. These clamps are water-cooled by having water cir-

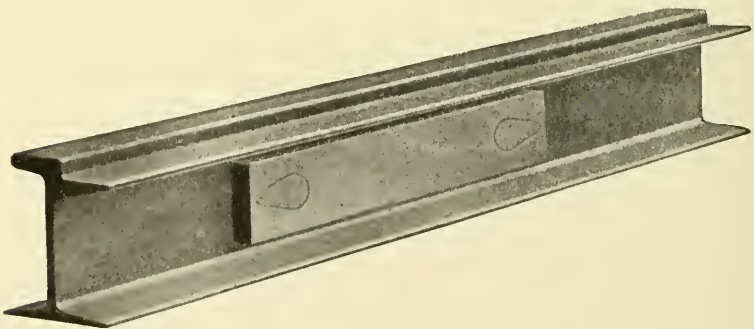

Fig. 231. Electrically Welded Joint

culated through them so that they will not become overheated at the point of contact with the steel blocks.

Thermit Welding. Dr. Hans Goldschmidt has invented a mixture which he calls "thermit" which has been found useful

in making rail welds. Thermit is a mixture of powdered aluminum and iron oxide and these have a strong tendency to combine after they have been ignited, producing by this combination intense heat accompanied by a reduction of the iron in pure form. In making a joint an iron mould is placed about the joint somewhat as in the cast-welding process. The space inside the mould is, however, very much smaller. A charge of the thermit, sufficient for a joint, is placed in a funnel-shaped sheet-iron crucible which is lined with refractory material. The bottom of this can be opened to allow the molten iron to flow into the mould. The charge is ignited by a small charge of fulminate and almost instantaneously the metal is ready for pouring. The combination of the materials is very vigorous so that the crucible must be covered to prevent them from flying out. This process has an advantage in that, as it does not require elaborate apparatus and a large crew of men to operate it, a few joints can be made to advantage. The iron which flows into the mould is at such a high temperature that it melts the steel of the rail with which it comes in contact and produces an actual weld.

TRACK SUPPORT

Ties. The greater portion of track is laid on *wooden ties*. These ties, in the most substantial wooden-tie construction, are 6 inches by 8 inches in section, and 8 feet long. They are spaced two feet between centers. Sometimes smaller ties, spaced farther apart, are used in cheaper forms of construction; but the foregoing figures are those of the best construction known in American railway practice. In paved streets, ties are usually employed, although sometimes what is known as *concrete stringer* construction is used instead of ties to support the rails. A strip of concrete about 12 inches deep is laid under each rail, and the rails are held to gauge by ties or tie rods placed at frequent intervals. Sometimes the concrete is made a continuous bed under the entire track. In most large cities the concrete foundation is used under all paving; and consequently, when concrete is used instead of ties to support the rails, this concrete is simply a continuation of the paving foundation. Where ties are used, they are laid sometimes in gravel, crushed stone, or sand, although frequently, in the largest cities, they

are embedded in concrete. Sometimes this concrete is extended under the ties, and sometimes it is simply put around the ties.

The increasing cost of wooden ties, the difficulty of obtaining good ones, and the comparatively short life of these ties, have resulted in the development of substitutes. Wooden ties, however, possess many advantages. They are cheap; they produce a resilient, easy-riding track; rails are easily and cheaply attached to them, etc. Efforts are, therefore, being made to extend the life of ties by means of preservatives, of which the most commonly used

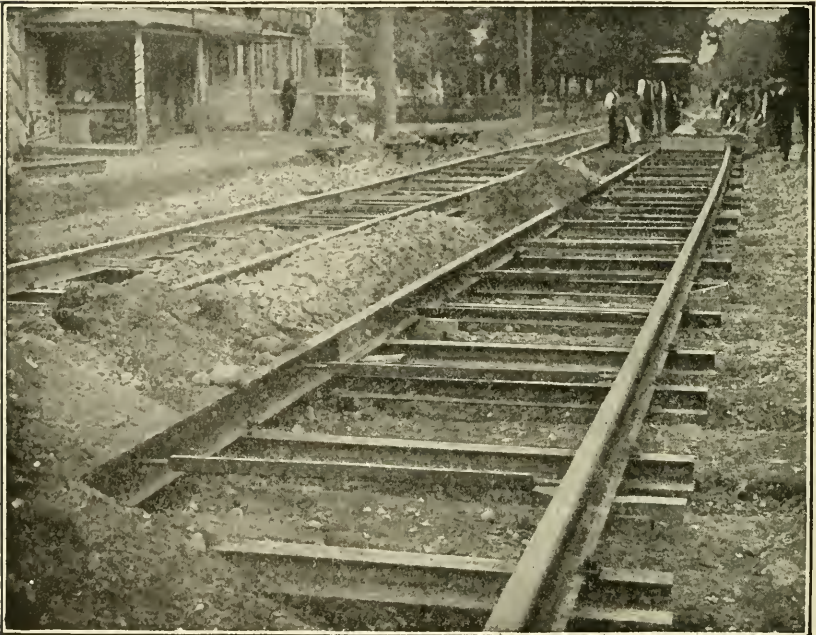

Fig. 232. Steel Tie and Tie-Rod Construction

are zinc chloride, creosote, and crude oil. In order to properly apply the preservative it is necessary to first remove the sap and air from the wood, which is accomplished by means of heat. On cooling, the wood tends to absorb the preservative. This matter is considered so important by our government that the Forest Service has established a Department of Wood Preservation. Any one who is interested in a practical way in preserving the life of ties, poles, posts, etc., can obtain informa-

"T" RAIL, STEEL TIE AND CONCRETE BALLAST CONSTRUCTION FOR CITY STREETS

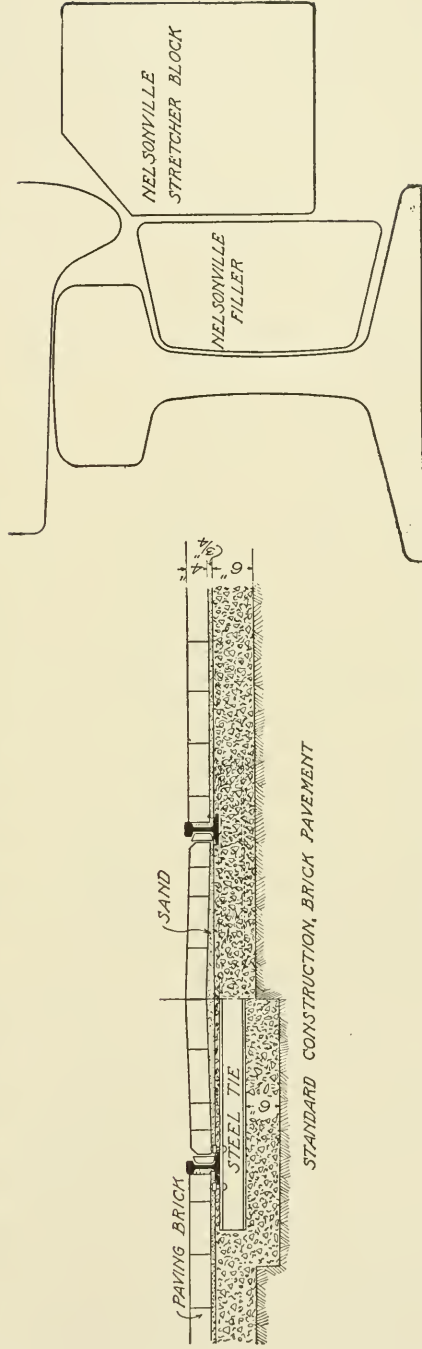
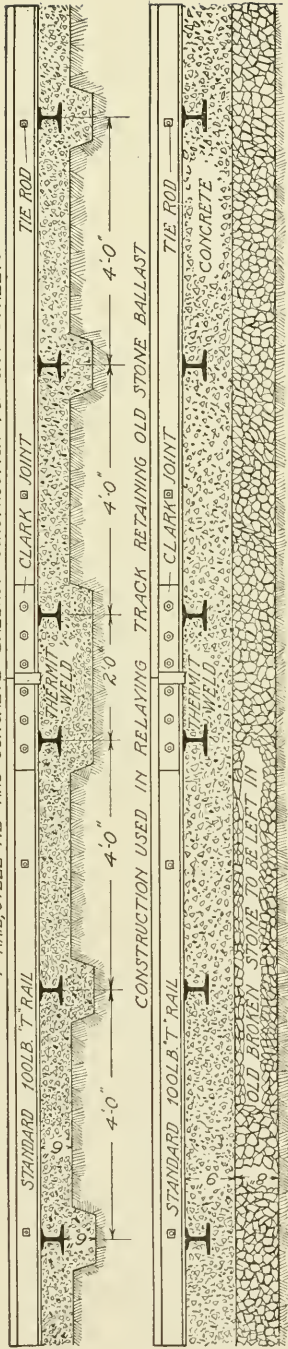

Fig. 233. Longitudinal and Transverse Section of Steel Tie Track Bed

tion and assistance from the Department. The steam railroads are adopting plans for tie preservation on a large scale and will thus, at least, double the life of their ties.

While efforts are being made to extend the life of wooden ties, substitutes are also coming rapidly into use. In cities the stringer construction, mentioned above, is popular. *Steel ties* are also being employed on a large scale. These are cross-ties laid like the wooden ones except that in city work they are bedded in concrete. Figs. 232 and 233 show the construction clearly. A feature shown in Fig. 232 which has not been mentioned before, is the use of tie rods which maintain the rails at the proper distance apart. These are flat straps with threaded bolts on the end. The latter pass through holes in the rail web.

Ballast. A ballast of gravel, broken stone, cinders, or other material which is self-draining and which will pack to form a solid bed under the ties, should be used to get the best results under all

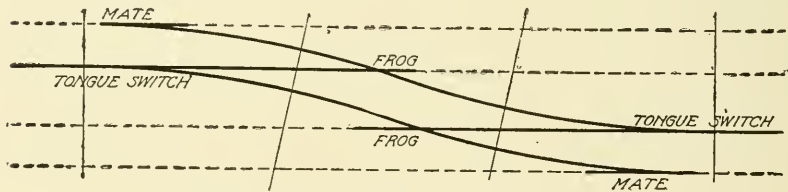

Fig. 234. Standard Right-Hand Cross-Over

forms of tie construction, whether in paved streets or on a private right of way, as on an interurban road. Of course, if concrete is placed under the ties, the gravel or rock ballast is not necessary. If ties are placed directly in soft earth, which forms mud when wet, they will work up and down under the weight of passing trains, and an insecure foundation for the track will be the result. In interurban work the ballast is brought up nearly to the top of the ties. This insures a quiet track, that is, there is much less vibration than if the track were insufficiently ballasted.

“SPECIAL WORK”

The special pieces of track construction necessary in cities form a most important feature as they must in many cases be designed for their particular locations. There are, however, standard pieces which have regular names and the student should be

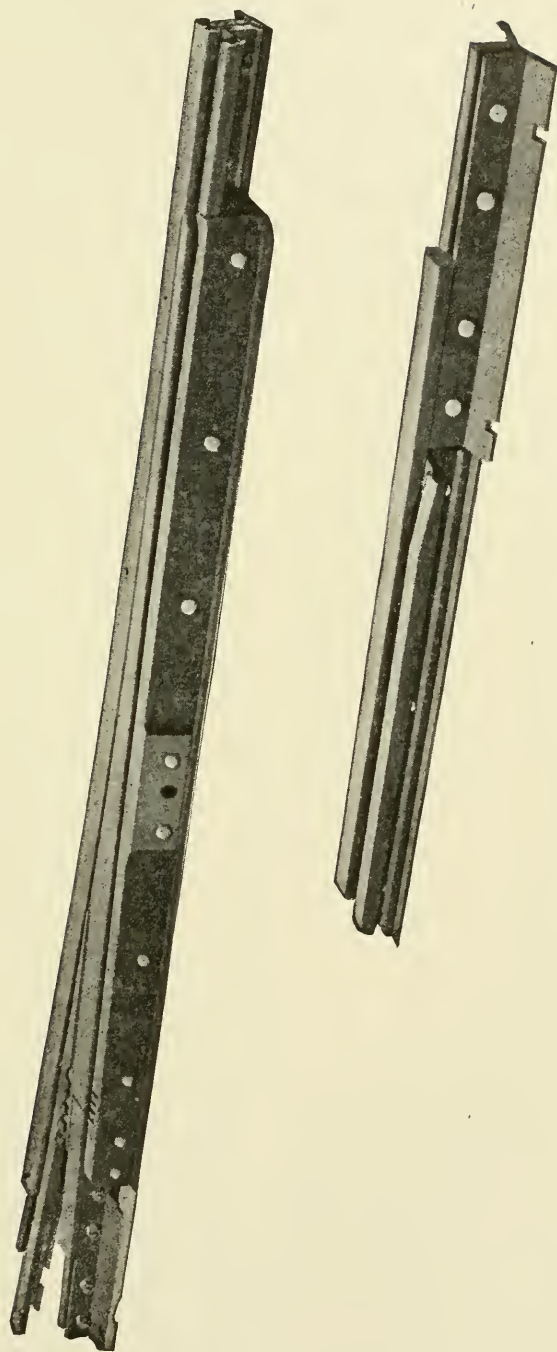

Fig. 235. Typical Steel Track Form. "Switch" in Two Parts

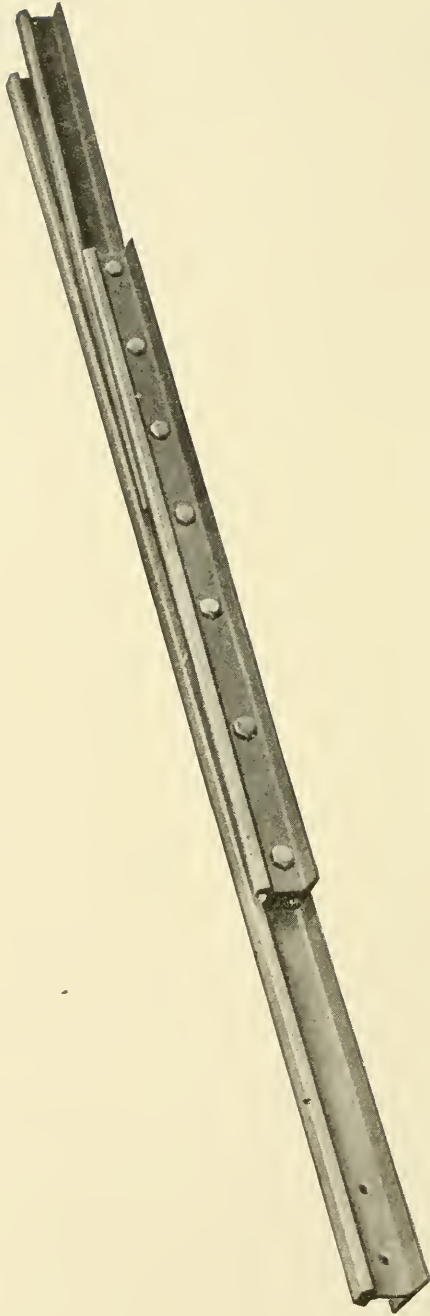

Fig. 236. Typical Steel Track Form. "Mate"

familiar with the most important of them. In the "cross-over," Fig. 234, the dash lines show the positions of the rails of the double track and the solid lines the special work. As the figure indicates there is a *switch* at each end of the cross-over by means of which a car can be deflected from the straight track. Opposite the switch is the *mate*; this is a junction which allows the wheel on that rail to follow the direction which has been determined by the position of the switch. The appearance of the switch is shown in Fig. 235. The switch is shown broken into two parts to reduce the space occupied in the illustration. The two sections are actually all in one piece. Beginning at the right-hand end of the switch we note first a pair of *angle plates* which connect it to the end of a rail. Next there is a piece of rail with a *guard rail* firmly attached. This leads up to a casting firmly bolted to the rail and forming between it and the rail head a shallow, flat-bottomed space in which plays a forged steel, *movable tongue*, hinged at the left. At the left end the casting widens out and the cross-over rail is attached to it by means of angle plates. The position of the tongue determines whether the car wheel shall follow the main or the cross-over rail.

Opposite the switch is the mate, as shown in Fig. 236. This is simply a Y joint of the main and the cross-over rails with a space between the heads to allow the car wheel to follow the main rail if it is not to be deflected to the cross-over rail. A short guard rail assists in guiding the wheel over the cross-over rail.

Where the rails cross at an angle, a *frog* is located. The construction of such a frog is shown in Fig. 237. It is built up of pieces of standard rail with filler blocks between as shown in the cross-section.

A good idea of a complicated piece of work may be obtained from Fig. 238. Here two double tracks cross and they are connected with each other by two sets of curves. The switches and mates used here are similar to those shown and in addition there are right angle and curve crosses. The light lines show the plain rail and the heavy lines the special pieces. The ends of each special piece are marked by black circles. The construction of these crosses is shown in Figs. 239 and 240, where the rails are held together by cast steel pieces cast in position. The castings on

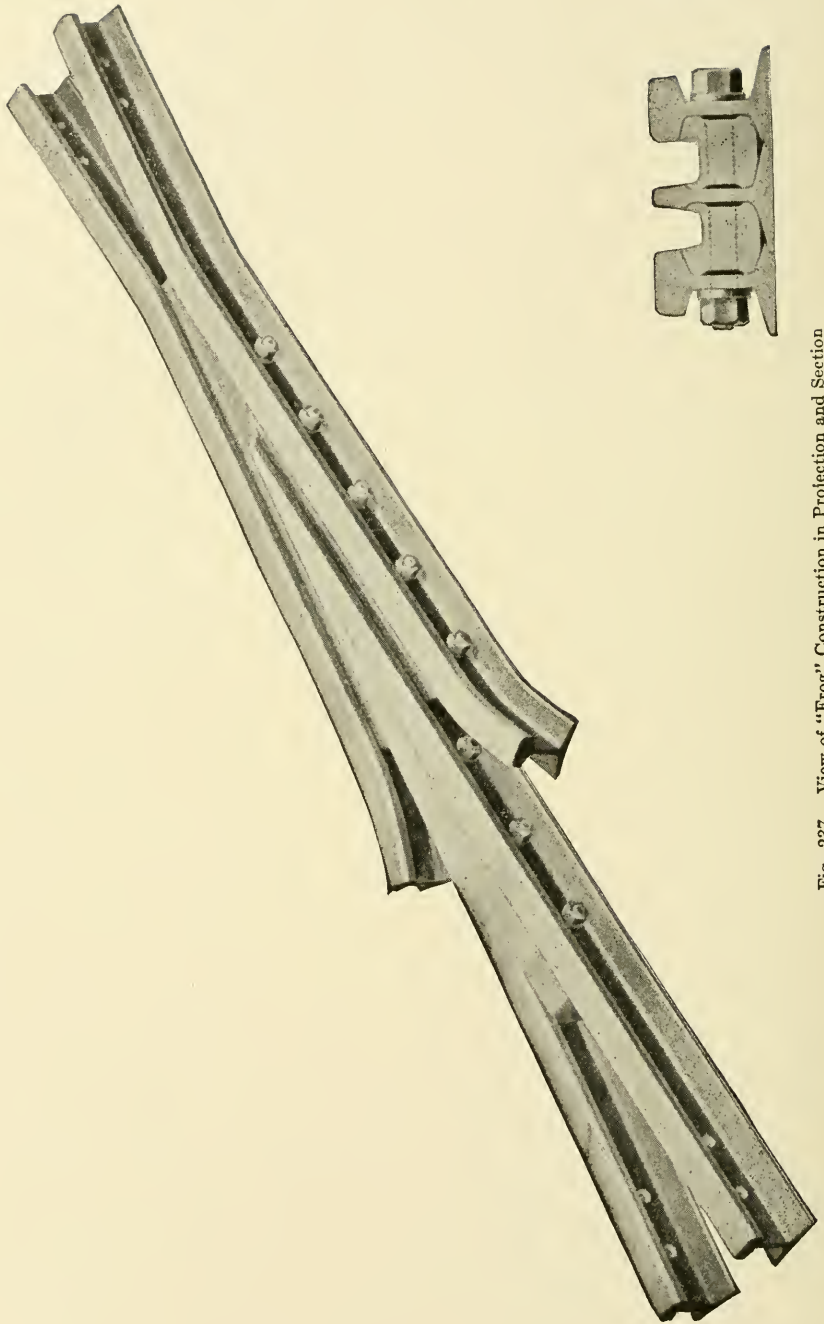

Fig. 237. View of "Frog" Construction in Projection and Section

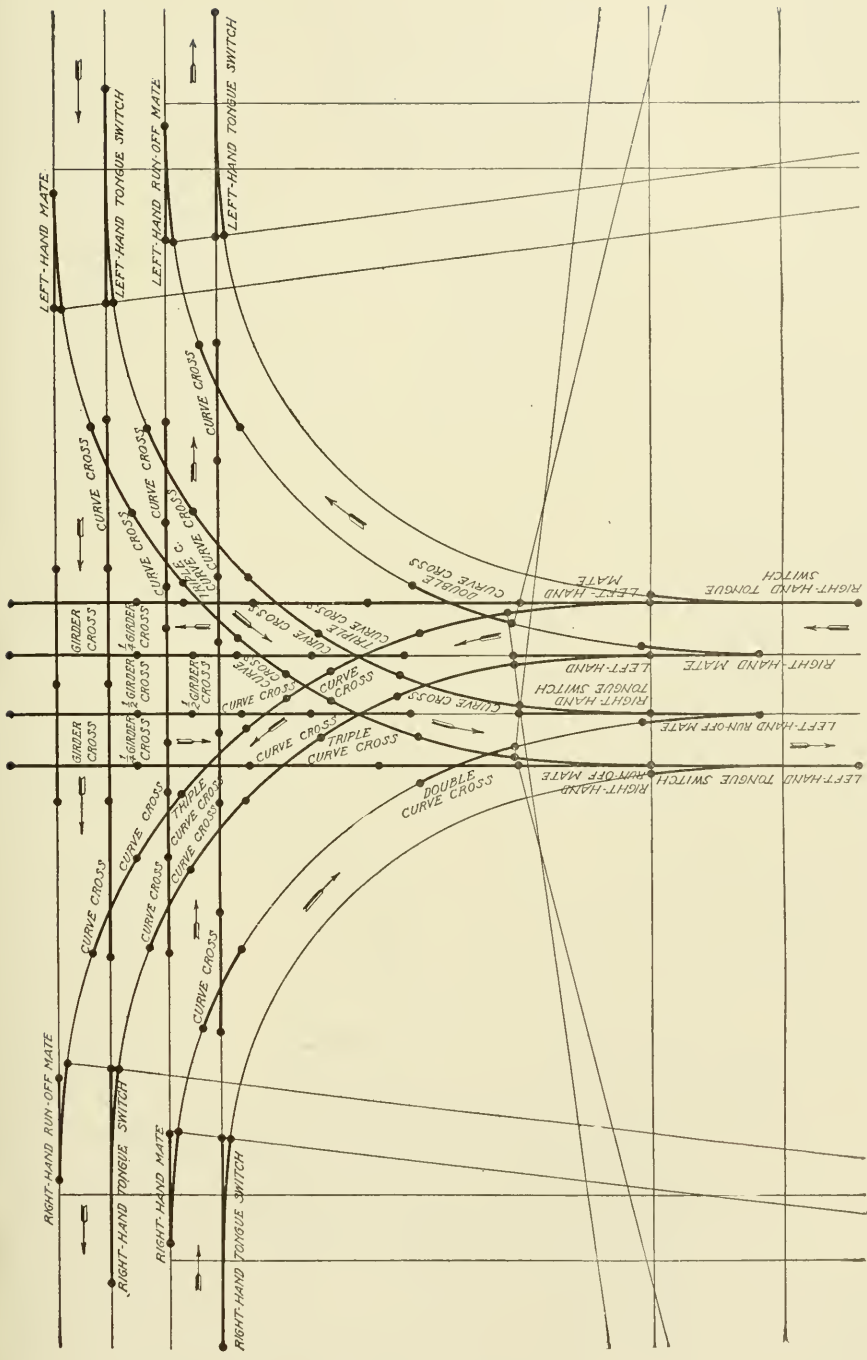

Fig. 238. Double Track Crossing with Connecting Curves

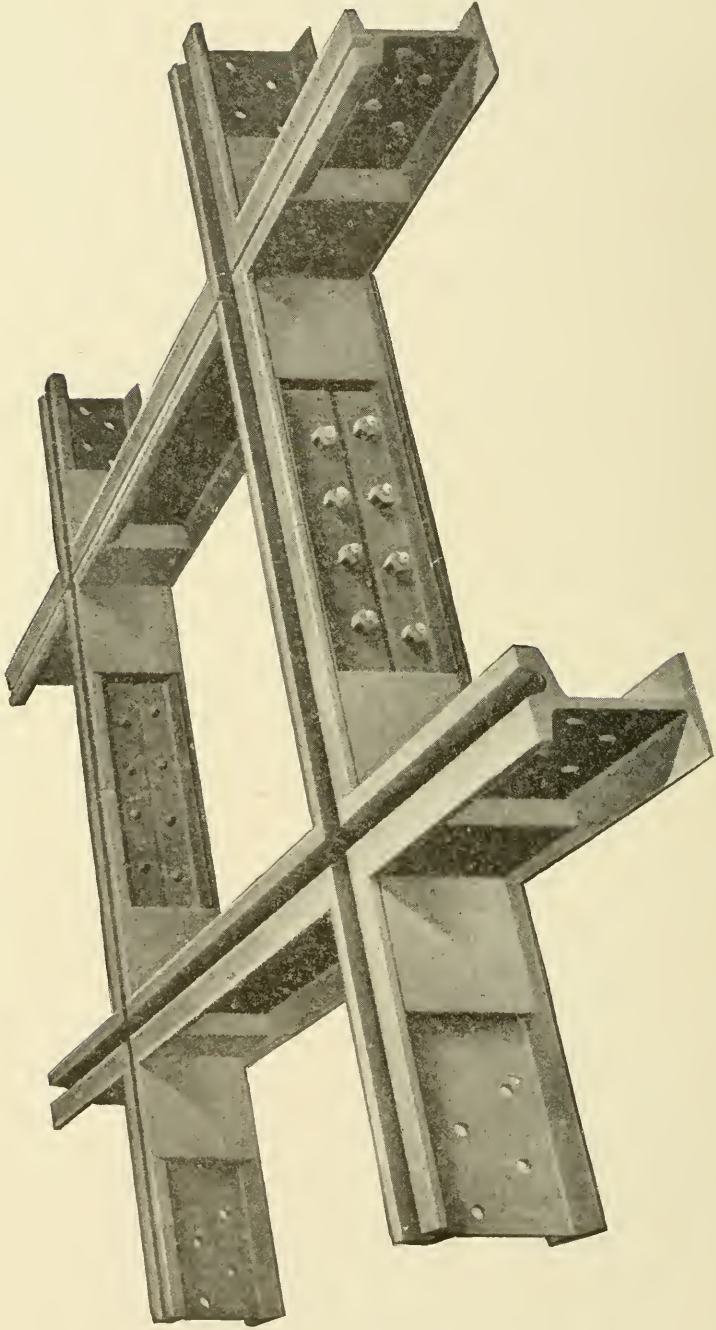

Fig. 239. Grooved Rail Right-Angled Cross

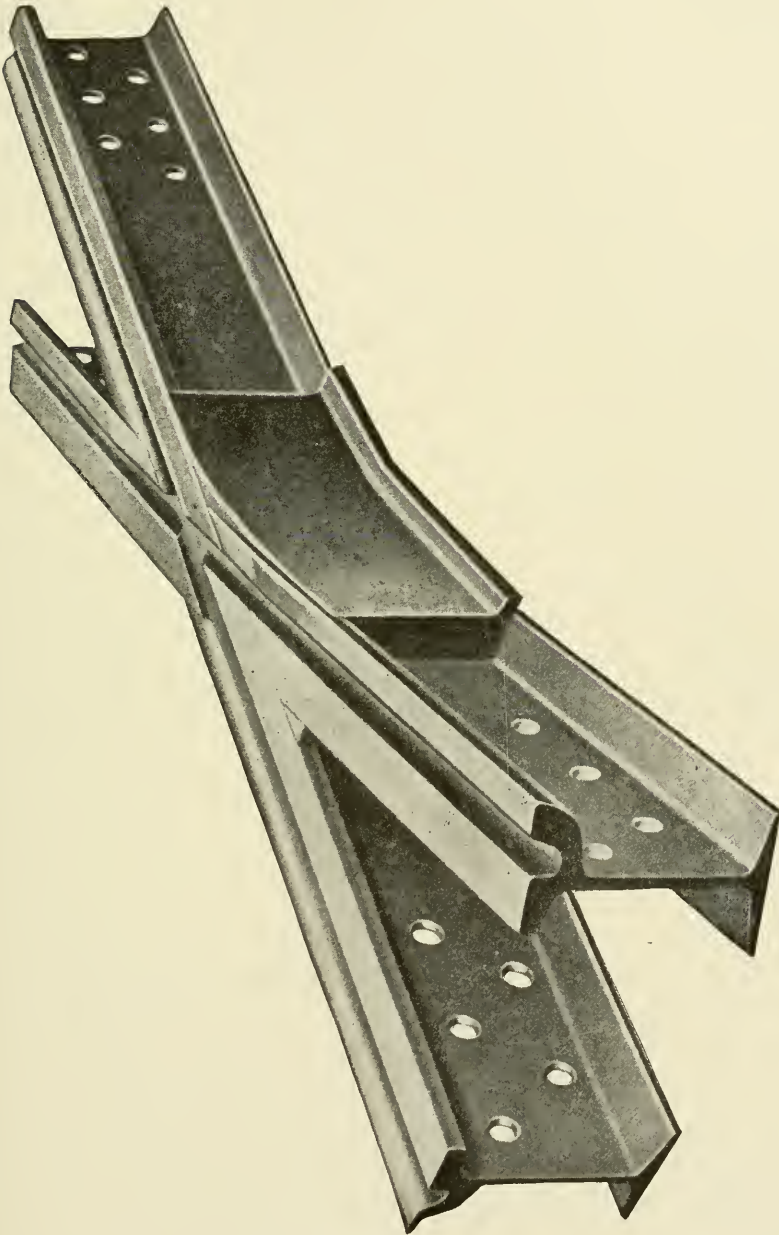

Fig. 240. Grooved Rail Curve Cross

the two sides are held together by the metal which has flowed through holes in the rail webs.

SPECIAL TRACK CONSTRUCTION

Underground Conduit System. The underground conduit system, in which the conductors conveying the current to the cars are located in a conduit under the tracks, is in use in two cities of the United States—New York City and Washington, D. C. The cost of this system, and the danger of interruption of the service where the drainage is not excellent, have prevented its more extensive adoption. The New York type of conduit, which is a good example of this construction, is shown in cross-section in Fig. 241. The conductors consist of T bars *CC* of steel, supported from porcelain cup insulators located 15 feet apart in the conduit. At each insulator a handhole is provided, Fig. 242,

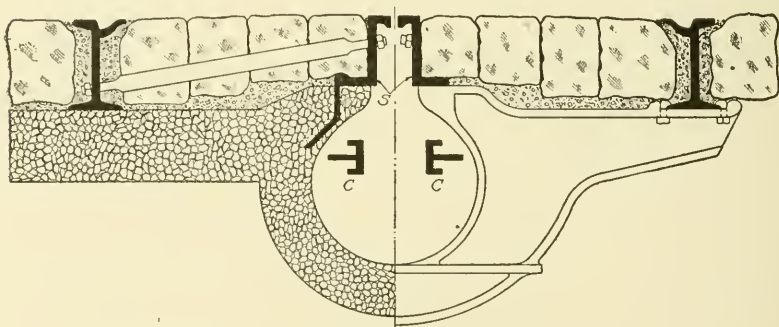

Fig. 241. Conduit for Underground Trolley System

to furnish access to the insulator from the street surface. Manholes are provided at intervals of about 150 feet, so that the dirt which collects in the conduit can be scraped into these manholes and removed at intervals. The manholes also serve as points of drainage connecting with the sewer system. Current is conducted to the car through a pair of contact shoes commonly called a *plow*, which has the two shoes insulated from each other and from the frame of the plow. These shoes are provided with flat springs that hold them against the conducting bars in the conduit. The shank of the plow is thin enough ($\frac{1}{8}$ inch) to enter

the slot of the conduit. The conductors pass up through the middle. These plows can, of course, be removed only when the car is over an open pit.

A conduit system of this kind is very expensive to build because of the fact that a very deep excavation must be made in the street to accommodate the conduit. The track rails, slot rails, and sheet-steel conduit lining are held in alignment by cast-iron yokes placed 5 feet apart. The entire space around and underneath these yokes is filled with concrete in order to give rigidity and a permanent track. Three expensive items, therefore, enter into the construction of a conduit road, namely, the deep excavation, which may call for the changing of other underground pipes or conduits in the street; the large amount of iron and steel needed for the yokes and slot rails; and the large amount of concrete needed.

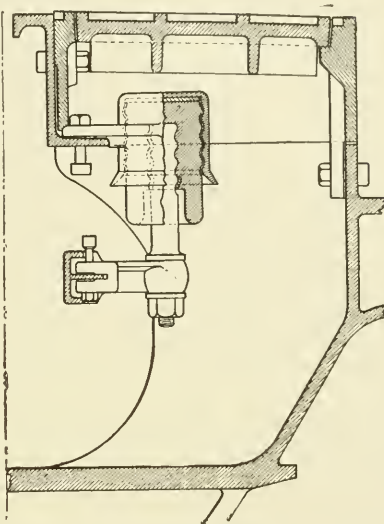

Fig. 242. Section of Underground Conduit Showing Handhole

STEAM RAILWAY ELECTRIFICATION

Applying electric power to steam railways may be done either by substituting electric locomotives for steam locomotives or by using multiple-unit car trains, or both. As examples of steam railways which are using electric locomotives in place of steam locomotives on parts of their lines may be mentioned the New York, New Haven and Hartford Railroad, the New York Central and Hudson River Railroad, the Pennsylvania Railroad, the Grand Trunk Railroad, the Eric Railroad, and others.

The multiple-unit cars have been largely used on the Long Island Railroad and they are used for suburban service in some of the others mentioned.

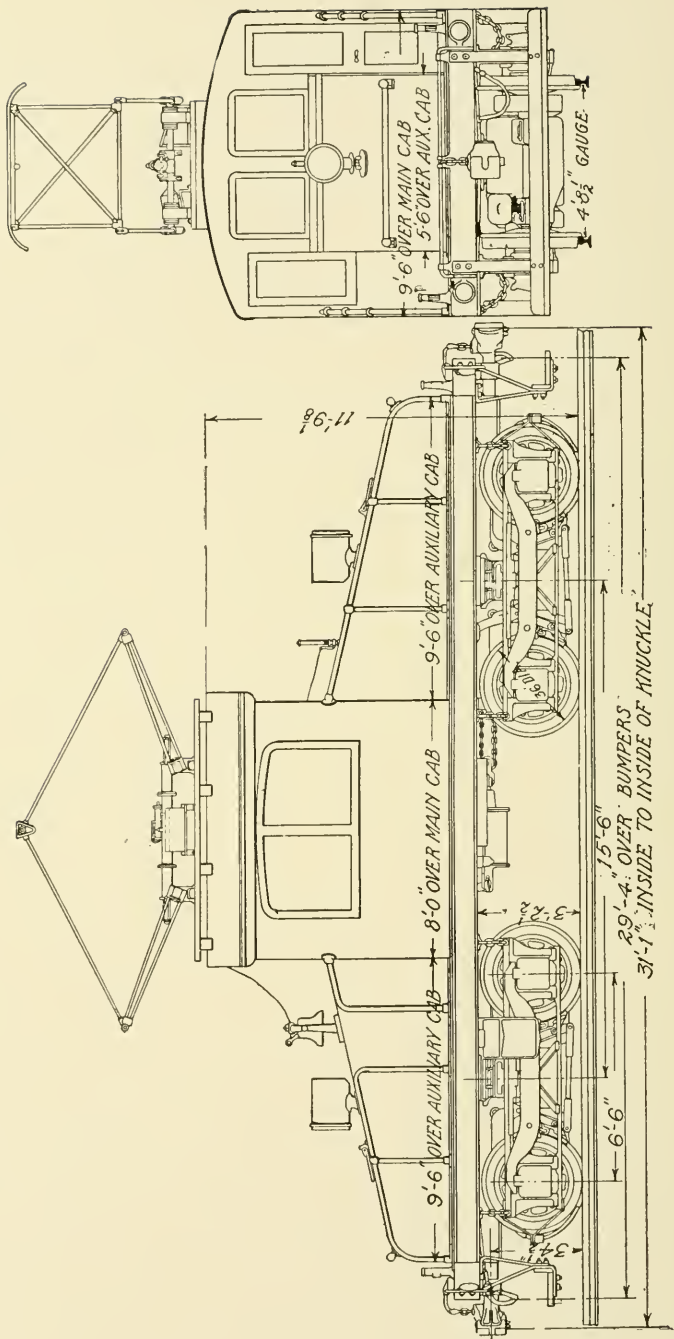

Fig. 243. Side and End View of Typical Electric Locomotive

ELECTRIC LOCOMOTIVES

Essentially the electric locomotive does not differ in principle from a small electric car. It consists of one or two trucks equipped either with gearless or with geared motors. The motors and control apparatus are so bulky that there is no room for passengers. This follows because the amount of power to be generated is so much larger than in the case of small cars.

The ordinary form of electric locomotive consists of a platform mounted upon two swivel trucks. The platform carries a cab which, in small-sized locomotives, occupies a small space in the middle of the platform. The cab contains controllers, measuring instruments, and some of the auxiliary apparatus. The remainder of the control apparatus is in many cases located under two sloping housings which cover the remainder of the platform. The general appearance of such a locomotive is shown in Fig. 243.

Some of the details of the equipment of such a locomotive are shown in Fig. 244, which consists of a plan and an elevation of the locomotive, both in section. The central portion, or cab, is conveniently arranged for the driver who sits on one of the seats located at the right-hand side of the cab. By right-hand in this case is meant the right-hand side when the motorman is looking toward either end. When the motorman is on the seat he can reach the master controller, the air-brake valves, the main switch, and any other control apparatus necessary in operating the locomotive. He can also see the air gauge and the electrical instruments.

In this locomotive the air-compressors are located in the center of the cab and under the hoods are the storage air tanks, sand boxes, contactors, resistance grids, control rheostats, and reverser. The functions of all of these pieces of apparatus are the same as in smaller cars and they have all been discussed in detail in earlier parts of the course.

DIRECT-CURRENT LOCOMOTIVES

The New York Central Locomotive. In very large locomotives great differences in design are found, there being more tendency to follow steam railway lines. One of the most interesting of the very large locomotives is that used by the New York Central Railroad at its New York terminal. Fig. 245 shows a side

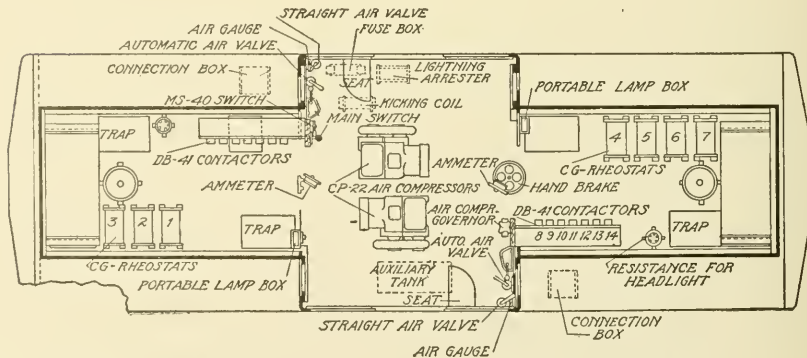
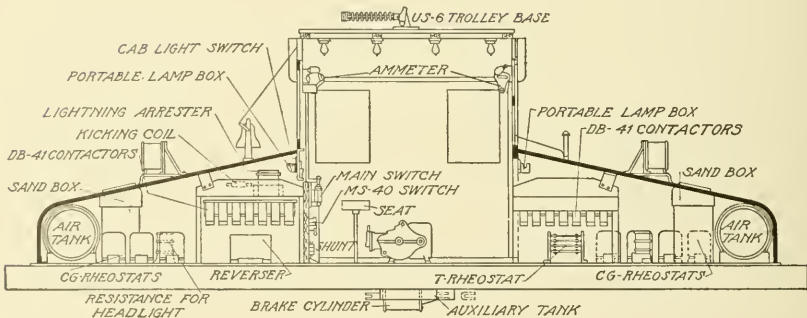
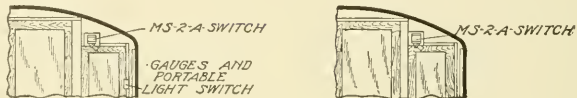
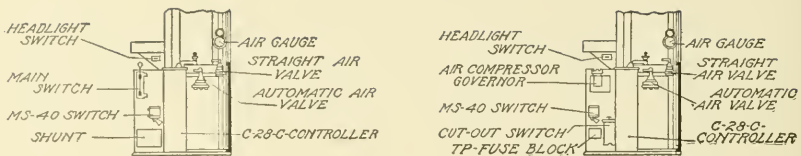

Fig. 244. Sectional Elevation and Plan of Typical Electric Locomotive

elevation and partial section of this locomotive. Fig. 246 is from a photograph showing its actual appearance.

The New York Central locomotive is driven by four direct-

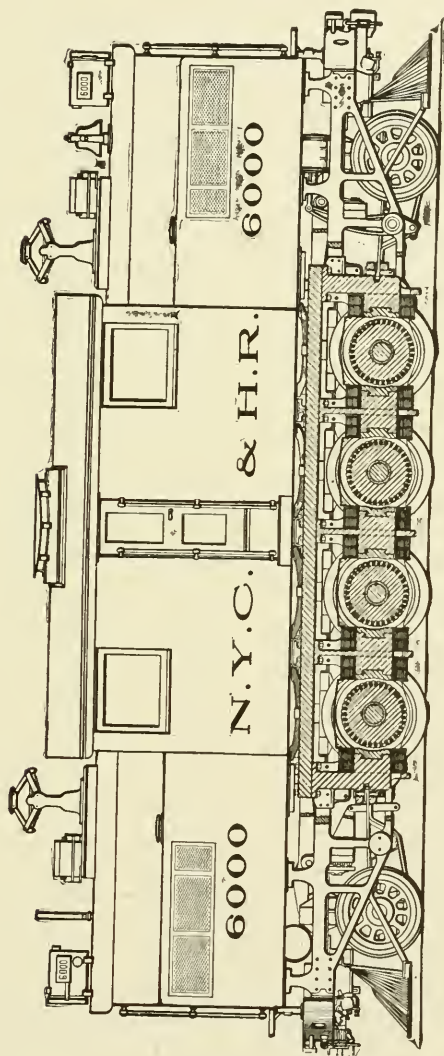

Fig. 245. New York Central Electric Locomotive in Elevation and Part Section

current, gearless, bipolar motors. The mounting of the motors is clearly shown in Fig. 245. The armatures are solidly mounted on the driving axles, while the pole pieces form a part of the spring-

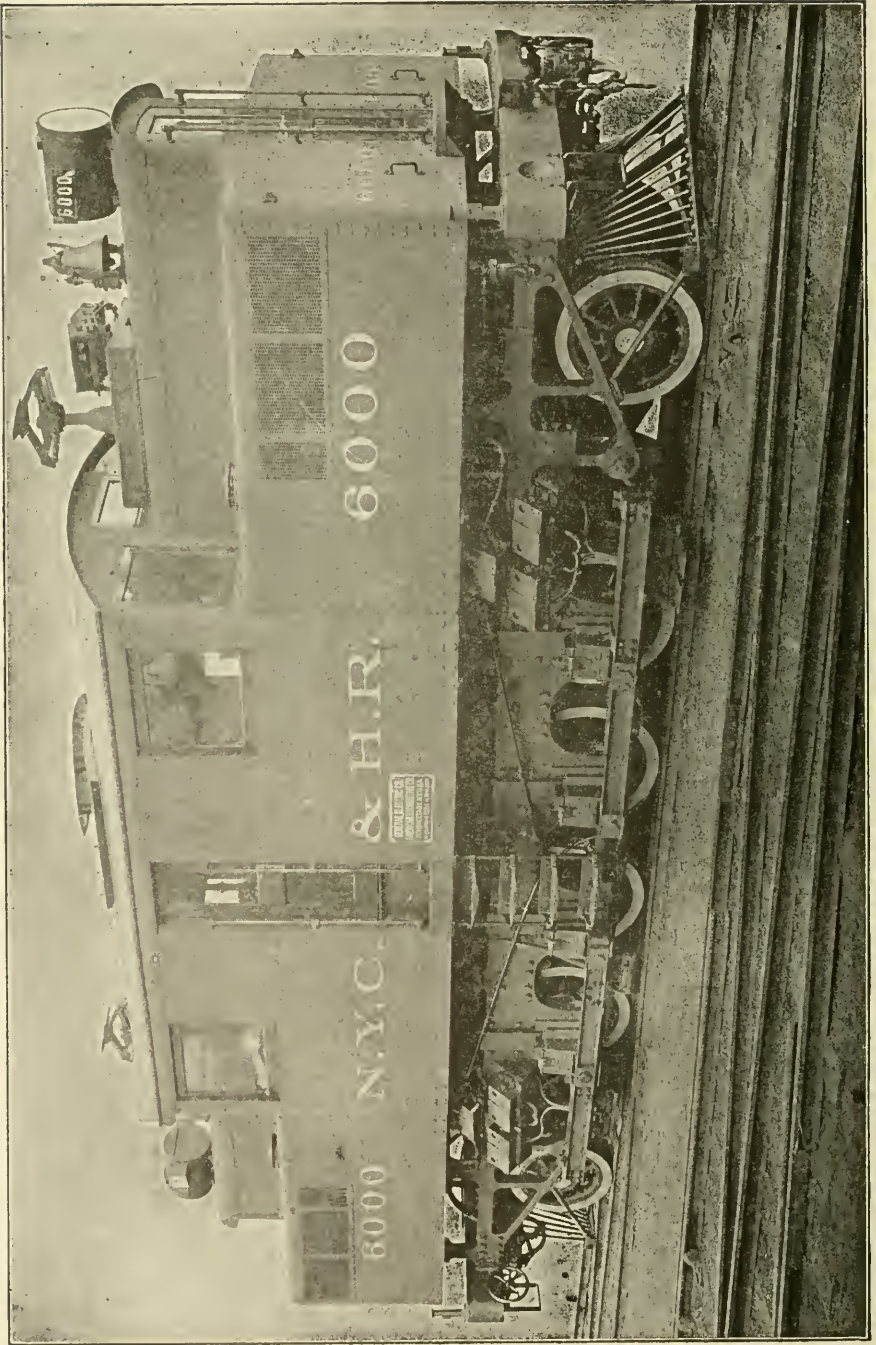

Fig. 246. New York Central Electric Locomotive Complete

supported truck frame. The truck frame has a vertical movement with respect to the armature. The pole pieces are prevented from binding on the armature by the use of a large air gap and rather flat pole shoes. The magnetic circuit of this equipment is from end to end of the four motors, returning through the steel frame.

Figures 247 and 248 show details of the motor construction. The motor is known as the General Electric S4, and has a rating of 550 h.p. The operating voltage is 600 and at rated load the locomotive draws 3,050 amperes. When drawing this current it produces 20,500 pounds tractive effort and makes a speed of 40 miles per hour.

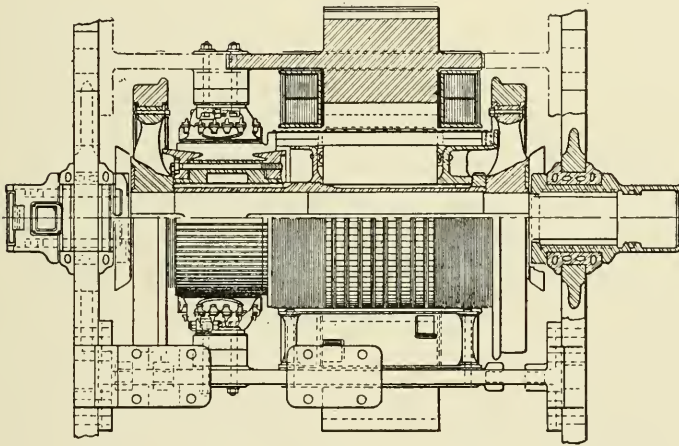

Fig. 247. Section of Motor Used on Locomotive Shown in Fig. 246

The control equipment is of the multiple-unit type, similar in general principle to the one described earlier. On account of the size of the motors it has been found practicable to have three running positions, namely, with the motors (a) in series, (b) in series-parallel, and (c) in parallel. The contactors for making these connections are located in the spaces beyond the ends of the cab. The use of the multiple-unit system permits the operation of two or more locomotives as a single unit if extra power is desired to move a heavy train. The control equipment contains a device to provide against excessive draft of current. A friction clutch, operated by a solenoid

which carries the current of one of the motors, prevents the movement of the operating lever of the controller when the current is excessive. This will be recognized as similar to the device described earlier in the course as one used in street railway work.

The attention of the student is called to the means provided for getting the current to the motors. Ordinarily in the New York Central terminal the source of current is a third-rail of the inverted type shown in Fig. 202, Part III. The contact shoes through which the current is taken from the rail are seen below the truck frame in Fig. 246. One pair is located near each end of the bottom of the side frame of the truck. The shoes are hinged slippers of iron which are pressed upward against the third rail by springs. The

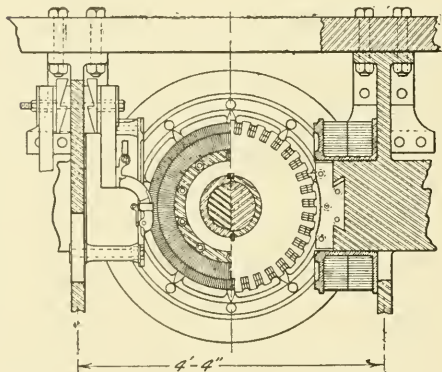

Fig. 248. End Section of New York Central Motor

hinged pieces are mounted in an iron frame which in turn is supported on an insulating block of wood.

At certain points it is necessary for these locomotives to draw their current from overhead conductors. For this purpose a pair of "pantograph" contact devices is mounted on the roof. The collecting device consists of four links, pinned together. A set of springs

pulls the shoe upward and it is retracted by an air piston operating in a cylinder. This piston is controlled from the engineer's cab.

The Pennsylvania Locomotive. A radically different type of locomotive from those previously described is that in use on the New York Terminal of the Pennsylvania Railroad. This locomotive was designed for high speed and large tractive effort. Its maximum capacity is 4,000 h. p. and its maximum tractive effort is 60,000 pounds or more. The complete locomotive, comprising two units, weighs nearly 165 tons.

The locomotive consists of two articulated units, each of which has one 600-volt, direct-current motor. The motors are mounted

on the tops of steel under-frames and they are connected to the driving wheels through side rods. This construction permits the use of a motor having a longer axle than would be possible were the motor mounted directly on the driving axle. The motor axle overhangs the driving wheels. On each end of each motor axle is a counterweighted crank. From this crank a connecting rod conveys the torque to a jack shaft upon which, at each end, is another counterweighted crank. From the jack-shaft crank a second connecting rod transmits the force to the driving wheels which are connected by a third connecting rod.

Figs. 249, 250, and 251 show the details of the construction of the essential features of this locomotive. Fig. 249 shows the machine practically complete but without the cab and the electrical control apparatus. From the mechanical standpoint the locomotive differs from the New York Central type in several important particulars. The wheel-base is very short as the rigid part of each unit contains but two drivers. Each unit has a swivel pony truck which is designed to hold the unit to the track without "nosing." There is not quite as much weight on the drivers as in the

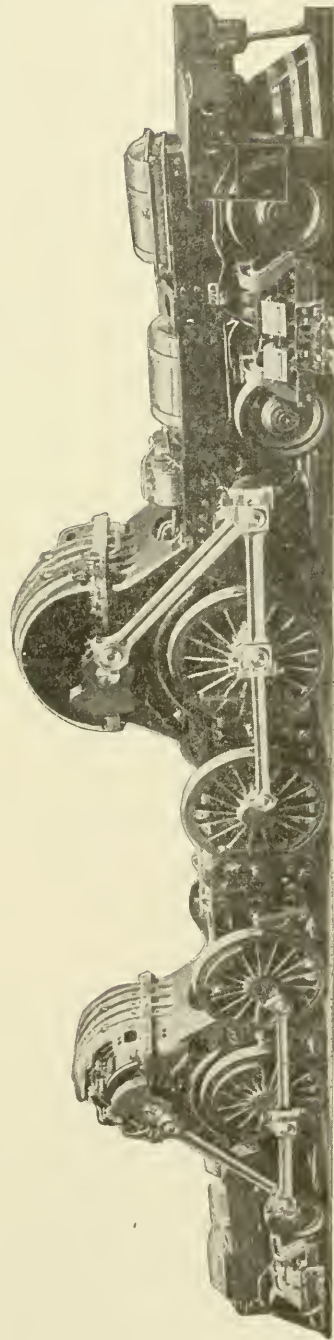

Fig. 249. Pennsylvania Locomotive without Cab and Control Apparatus

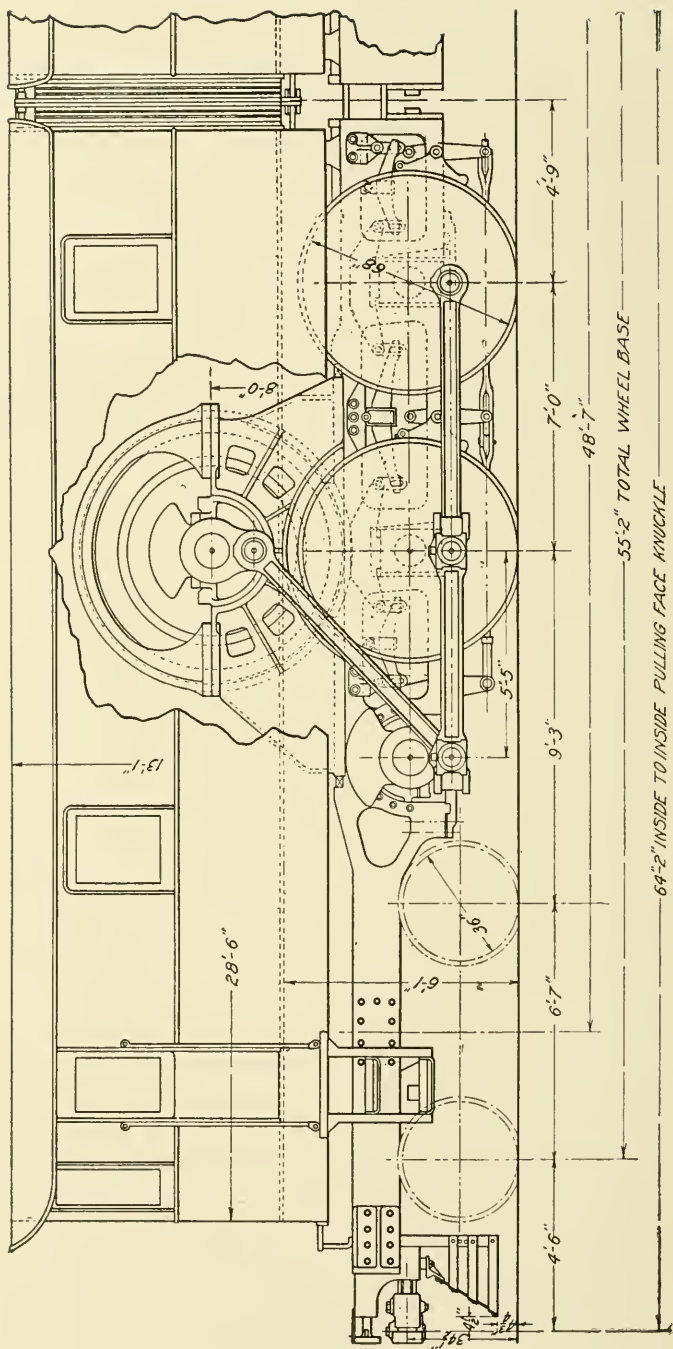

Fig. 250. Part Section and Elevation of One Unit of Pennsylvania Locomotive Showing Transmission

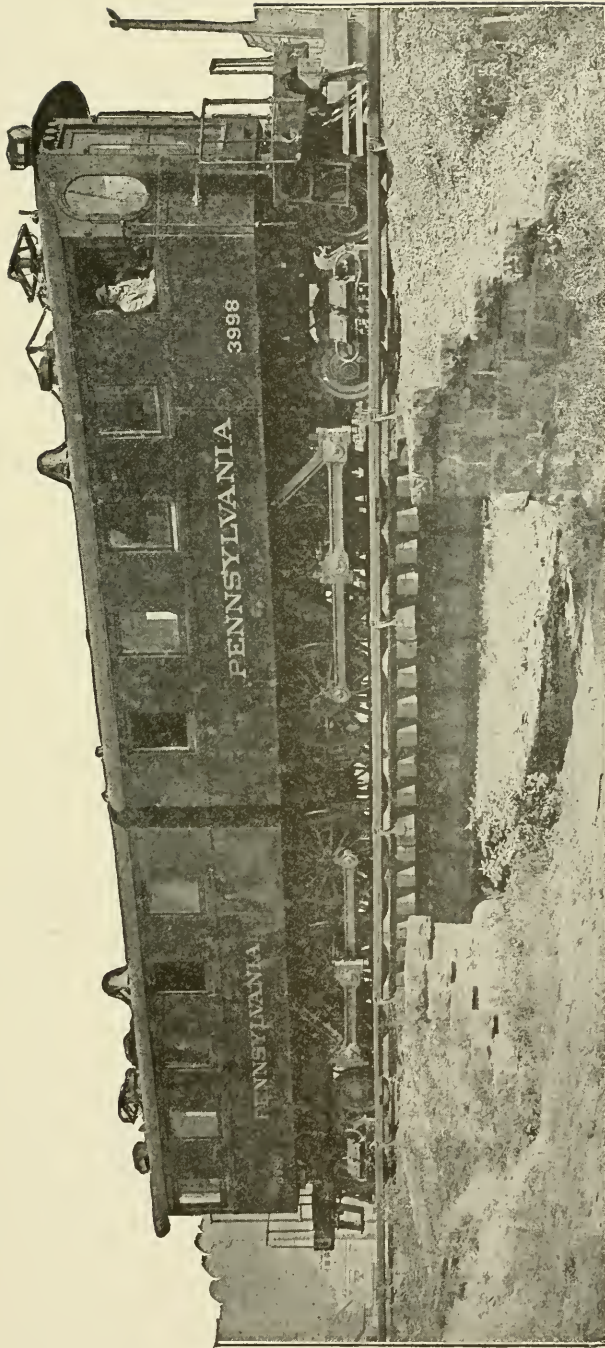

Fig. 251. Pennsylvania Locomotive Complete on Road Bed

other machine, about 100 tons in this case. The countershaft form of drive is entirely novel in this country, but as the side-rod construction permits the use of a high motor mounting, the center of gravity of the locomotive is high and this is considered by many engineers a matter of great importance. The high center of gravity allows the body to swing sidewise under the action of side forces such as are produced in rounding curves and this relieves the track rails of strain.

The motors of this locomotive are the largest which have been used in railway work. Their general appearance is shown in Fig.

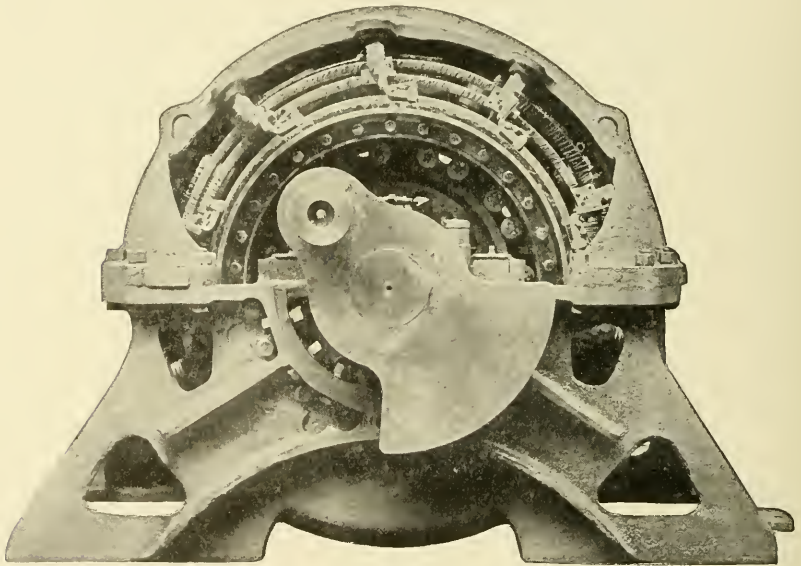

Fig. 252. Side View of Pennsylvania Locomotive Motor

252 and that of the armature and commutator in Fig. 253. The motor is of the series type with ten field poles and ten commutating poles. The commutating poles are small poles located between the main poles and furnishing an auxiliary magnetic field to assist in reversing the current as the armature coils pass under the brushes, at which time they are short-circuited for an instant. The motors are located in the cab where they are free from dirt and dampness so that the frames can be entirely open. This assists in ventilating the motors and permits them to carry their load without overheating.

ALTERNATING CURRENT LOCOMOTIVES—SINGLE PHASE

The New Haven Gearless Locomotive. The New York, New Haven and Hartford Railroad was one of the first to adopt electricity for motive power on a large scale. This railroad took a radical step in selecting alternating-current series motors for their locomotives. This type of motor permits the use of a high trolley voltage, so that the transmission efficiency is high. By means of transformers carried on the cars the voltage is reduced to that necessary for the motors.

The essential features of the series motor as adapted to alternating-current circuits were explained earlier in the course. The

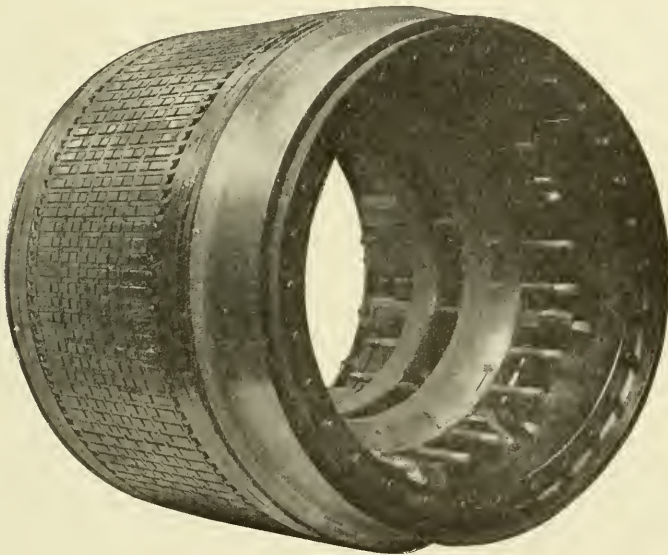

Fig. 253. Armature and Commutator of Pennsylvania Motor

electrical connections are the same as in the direct-current series motor but the field must be weak, the magnetic circuit must be laminated, a compensating winding to neutralize the magnetic effect of the armature on the field must be provided, and high-resistance leads must be placed between the armature winding and the commutator bars to keep down the current which would flow in the coils short-circuited by the brushes due to their presence in an alternating magnetic field.

The design and structural difficulties resulting from the above

features have been overcome and a perfectly satisfactory motor is now available. These motors have been in use for years on the New Haven Railroad and in other places with entire success.

The early New Haven locomotives consisted of a body mounted upon two swivel trucks each containing two 250-h. p., single-phase, series motors, requiring about 450 volts for full capacity operation. The motors, one of which is shown on its axle in Fig. 254, are gearless but they are not mounted rigidly on the axles as are the motors

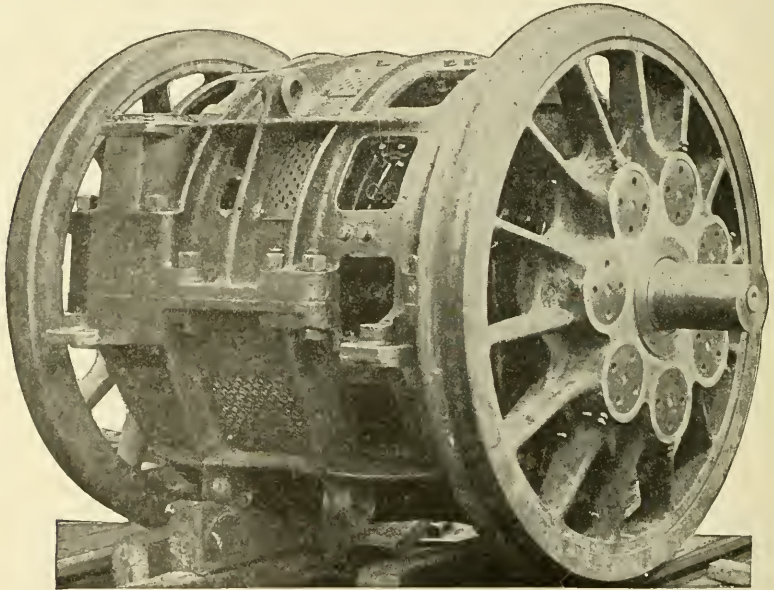

Fig. 254. Motor Mounted on Its Axle

of the New York Central Railroad. Fig. 255 shows the truck without motors and Fig. 256, the truck complete. The field frame with the armature is spring-supported from a frame which rests on the journal boxes, as shown in Fig. 257. The armature shaft is a hollow quill which surrounds the car axle without touching it. On this quill are the motor bearings which preserve the correct relation of armature and field. On each end of the quill is a plate, see Fig. 258, from which project seven round pins. These pins fit very loosely in corresponding sockets on the inside of each wheel hub, which is made very large for the purpose. Between the pins and the sides

of the sockets are eccentric coiled springs which allow sufficient movement to give the necessary flexibility to the drive. The torque

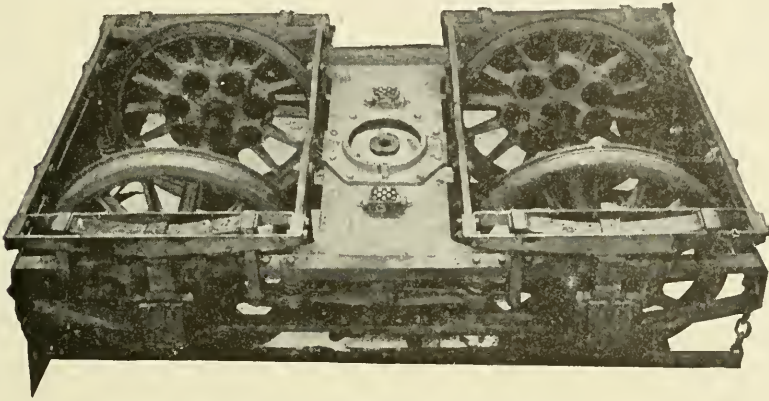

Fig. 255. View of Truck without Motors

of the armature is transmitted to the driving wheels through these eccentric springs.

The control of this equipment when operating on alternating current is not by the series-parallel method which is used with direct-current, but by variation in the applied voltage. The current is received from the overhead wire at 11,000 volts. This voltage is

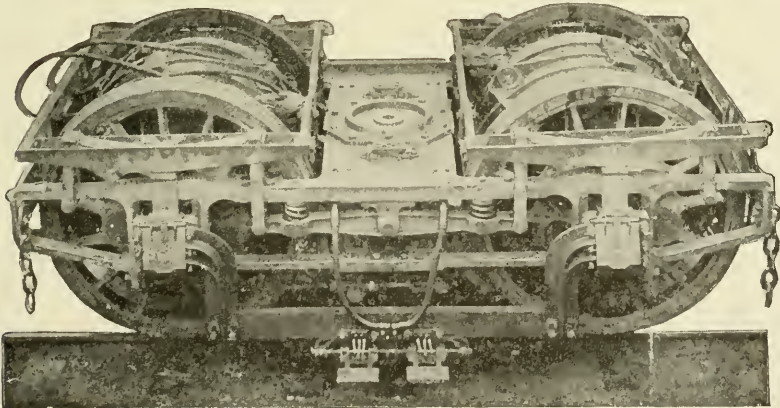

Fig. 256. View of Truck Complete

reduced by the transformers to the value required for the motors. The transformers are provided with several taps so that different

voltages can be obtained. This furnishes a very efficient form of control. The various contacts are made by means of the Westinghouse electropneumatic contactors described earlier.

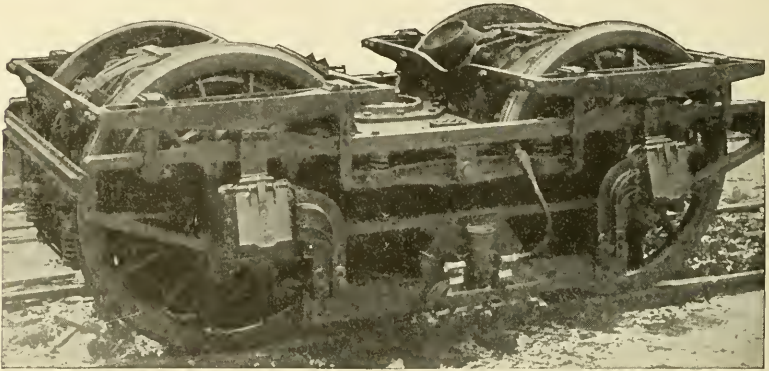

Fig. 257. View of Truck Showing Spring Supports for Motor

The New Haven locomotives enter New York on the New York Central tracks and have thus to operate on direct current. Fortunately the alternating-current series motor is well adapted to direct current. When operating thus the motors are connected for series-parallel control. Additional high-speed controller positions in which the motor field circuits are shunted, are also provided.

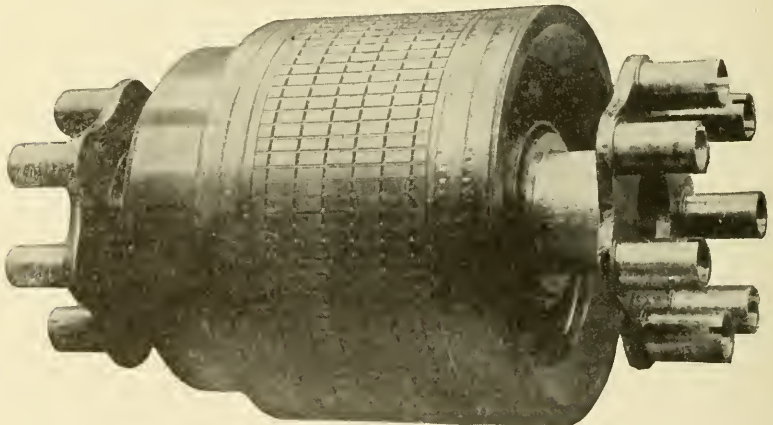

Fig. 258. View of Hollow Armature Shaft and Pin Plate

Current is normally taken from the trolley wire through a pantograph as shown in Fig. 259, which shows the complete loco-

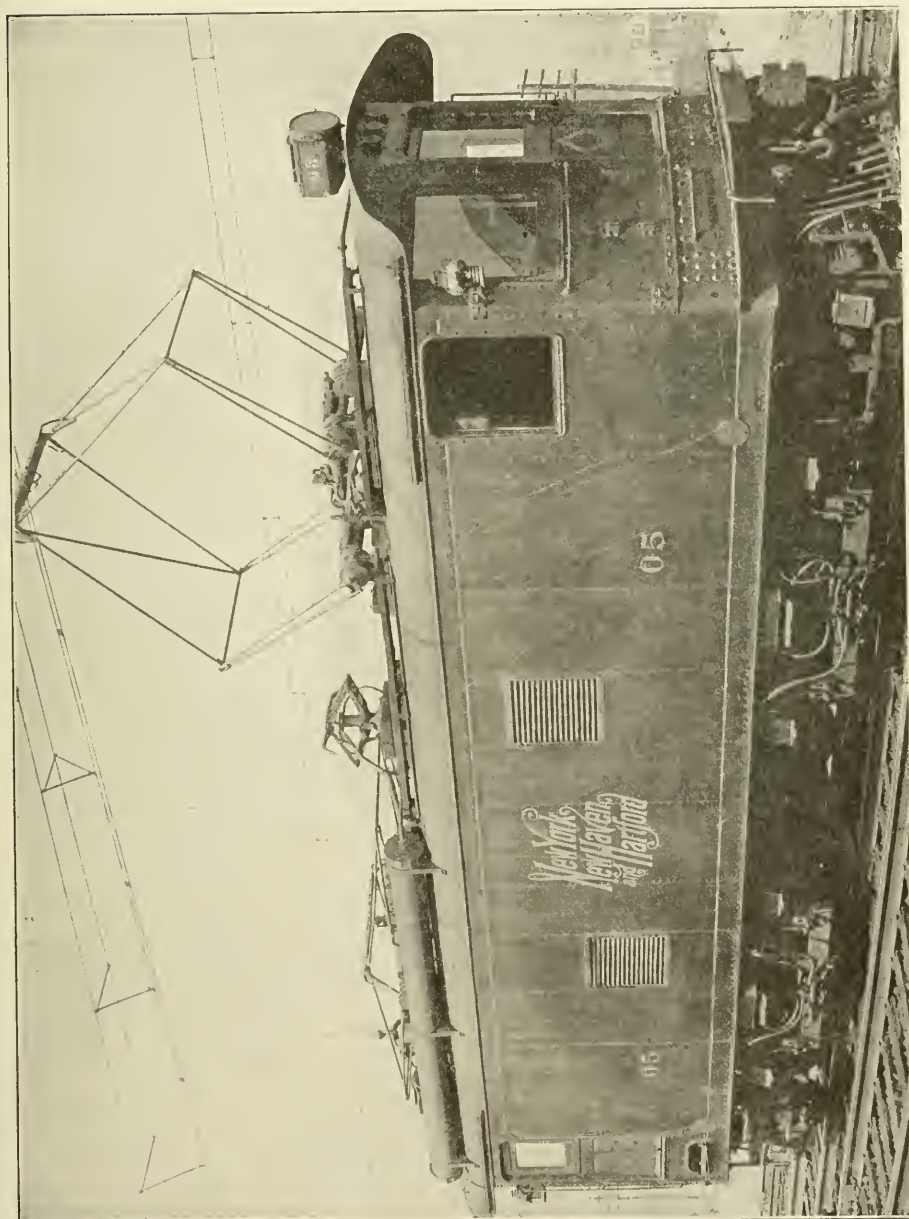

Fig. 259. New York, New Haven and Hartford Locomotive Showing Pantograph Trolley

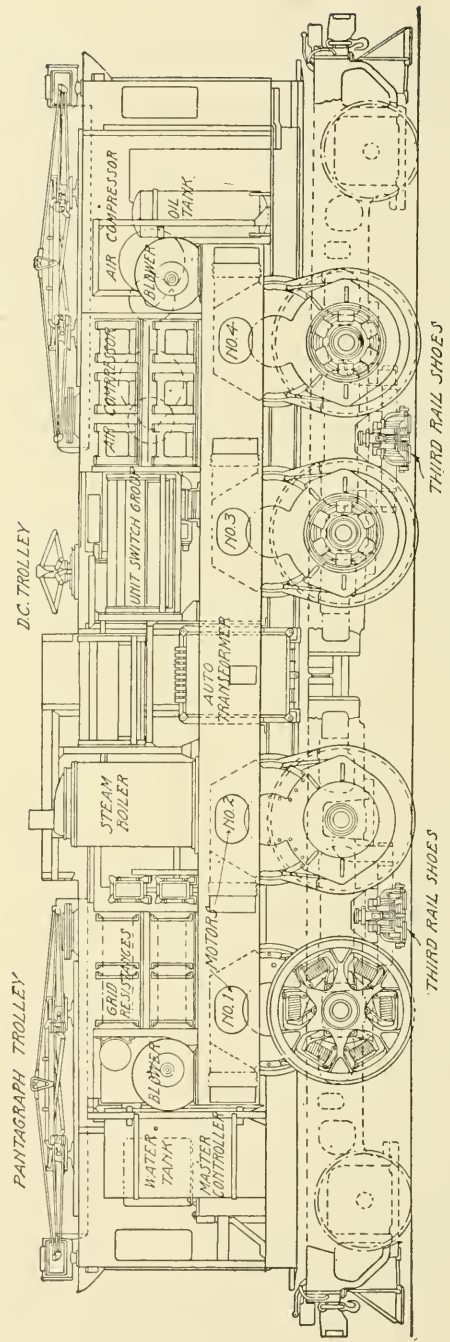

Fig. 260. Side Elevation of Late Model of New York, New Haven and Hartford Locomotive Showing Arrangement of Principal Parts



Fig. 261. Locomotive of Fig. 260 with Cab and Control Apparatus Removed

motive. This is operated by compressed air and is similar in general principle to the auxiliary collecting device used on the New York Central locomotives. Third rail shoes are used for the direct current and an auxiliary overhead collector is provided for use in locations where only direct-current overhead supply is available.

The mechanical features of the New Haven locomotive are not substantially different from those of an interurban car. It was

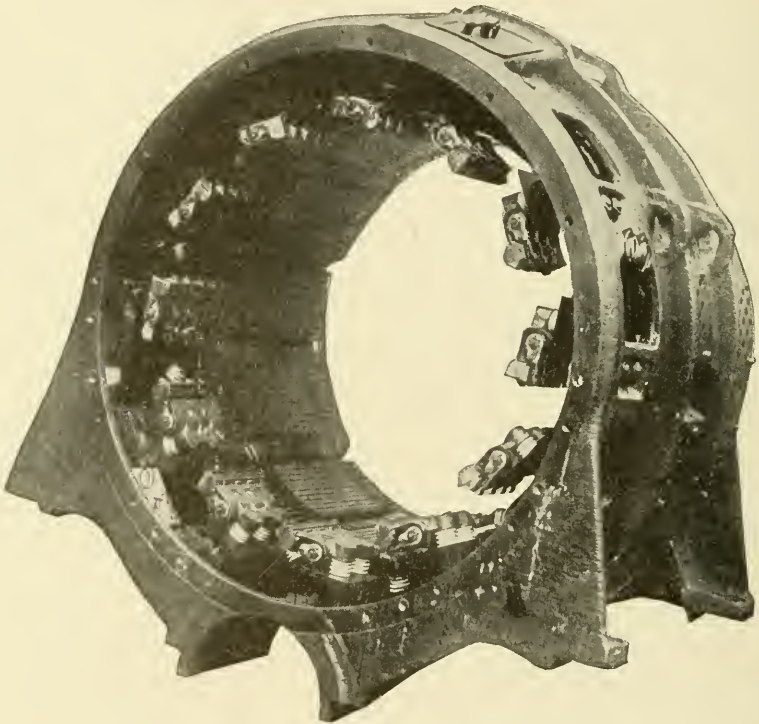

Fig. 262. Field Circuits and Brush Holders of Motors Shown in Fig. 261

found, however, after the locomotives had been in use some time that there was a tendency toward nosing. A pair of pony wheels was, therefore, attached at each end of the locomotive for the purpose of steadying it.

A later type of locomotive developed for the New Haven Railroad has some features similar to those of the Pennsylvania type. Each locomotive consists of two articulated units as in the older type, but the motors are mounted above the axles instead of on them.

Power is transmitted to the car axles by spur gearing. The gears are not mounted rigidly on the driving wheels, but upon a quill surrounding the driving axle which drives the wheels through a number of helical springs. Fig. 260, which is a side elevation of the locomotive, shows the arrangement of the principal parts. Fig. 261 shows how the equipment looks with the cab and control apparatus removed. Fig. 262 shows the field circuit with the brush holders. The compensating winding appears in this figure located in slots formed in the pole faces. The armature of the motor is shown in Fig. 263. Attention is called to the ventilating fans which appear on the right-hand end of the armature.

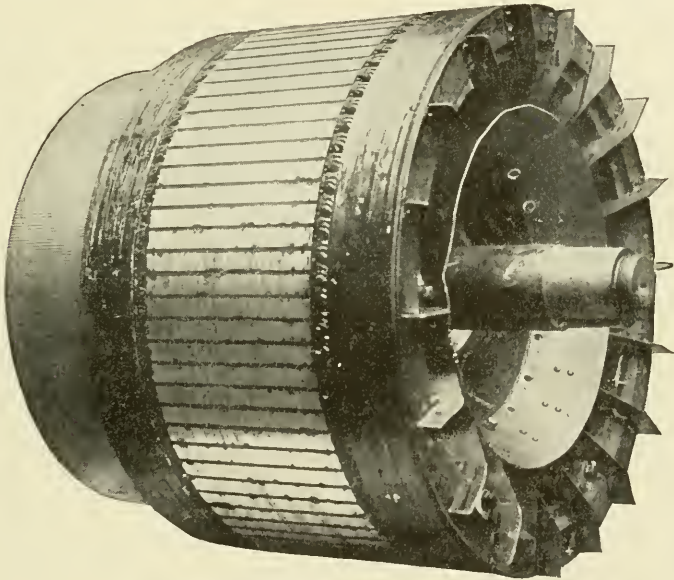

Fig. 263. Armature of Motor Shown in Fig. 261

The Grand Trunk Locomotive. The Grand Trunk Railroad uses a number of alternating-current locomotives in the St. Clair tunnel. Each locomotive is made in two separate units, each unit having three axles with a 250 h.p., single-phase motor geared to it. The motors are designed to operate at 235 volts with a frequency of 25 cycles per second. The motors are connected in multiple and are supplied with a variable voltage from the transformers. The speed is controlled by this variation in voltage. The motors

are mounted as in small cars, one side being supported on axle bearings, and are geared to the axles in the usual manner. A motor and axle with driving wheels are shown in Fig. 264, while the appearance of the complete double locomotive is shown in Fig. 265.

ALTERNATING CURRENT LOCOMOTIVES—POLYPHASE

Polyphase Traction Motors. The polyphase motor is inherently a constant-speed motor and hence does not possess the qualifications ordinarily required of motors for traction service. However, there are conditions in which the accelerating properties of the series motor are not required and where constant speed is not

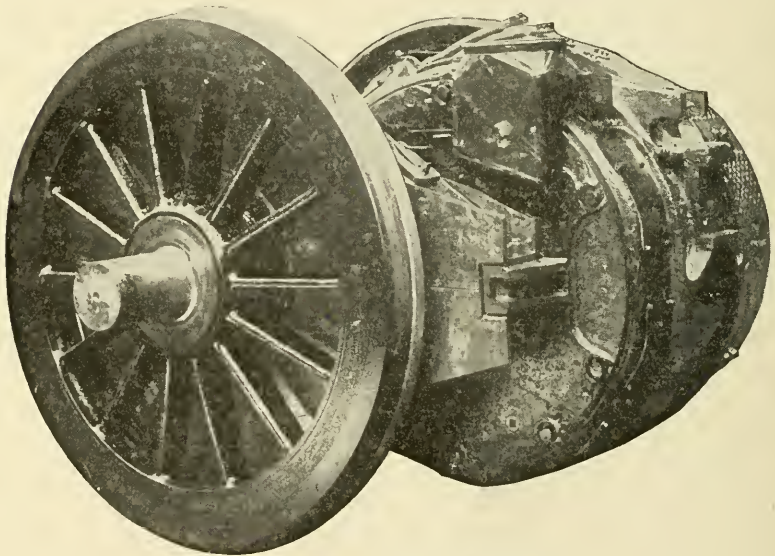

Fig. 264. Grand Trunk Locomotive Motor Mounted on Driving Wheels

a disadvantage. Good examples of such conditions are found in the mountain-climbing railways of Switzerland. In these the speed is low and it is desirable to have this speed maintained, whether the car is on a level track, is ascending a grade, or is descending a grade. In the latter case if the line voltage is not interrupted, the motors act as generators and restore power to the line, at the same time holding the car at a practically uniform speed. This power-regenerating feature is not practicable with series motors but it is easy to utilize with constant-speed motors. It is interesting to

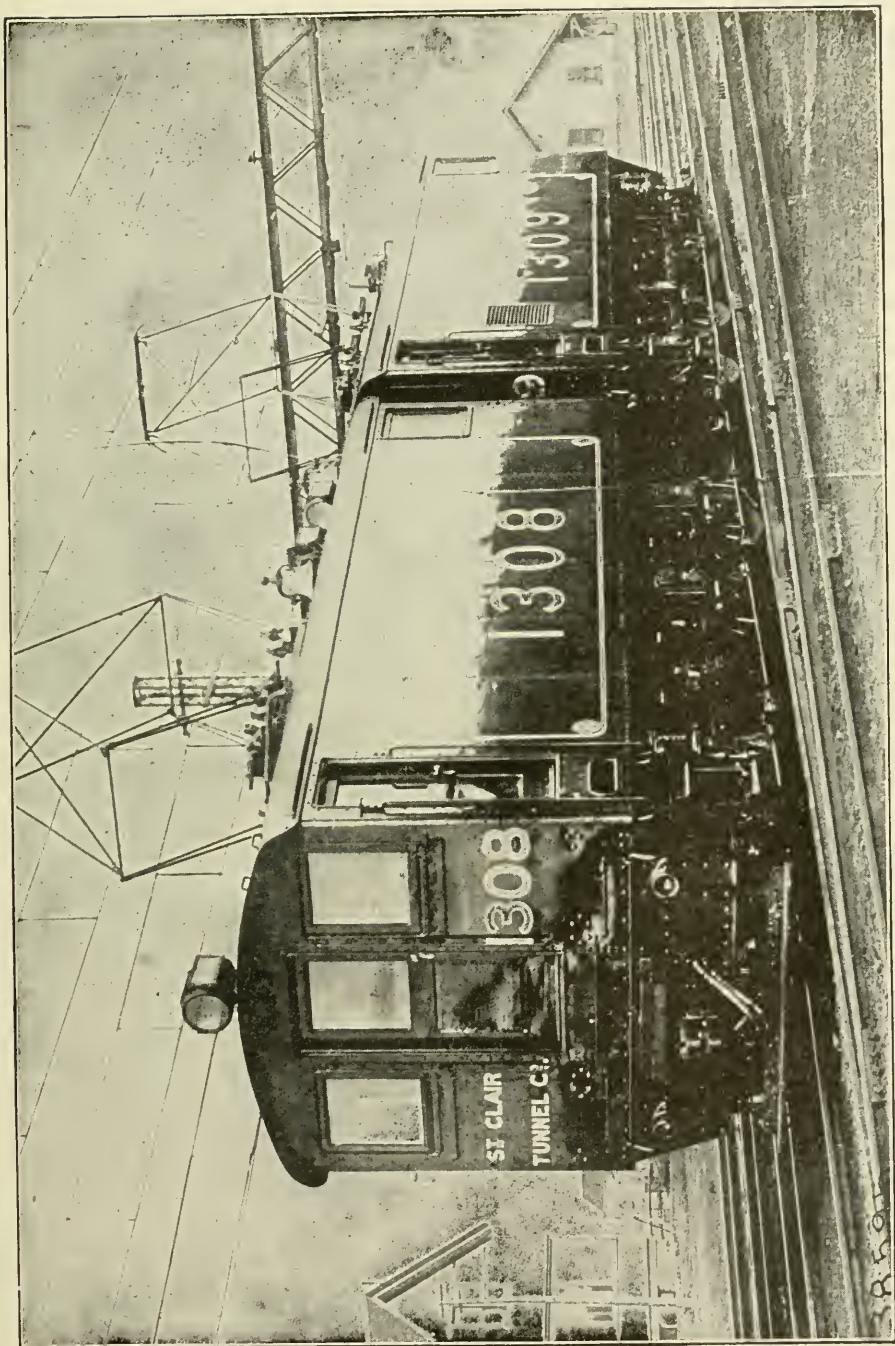

Fig. 265. Grand Trunk St. Clair Tunnel Double Locomotive

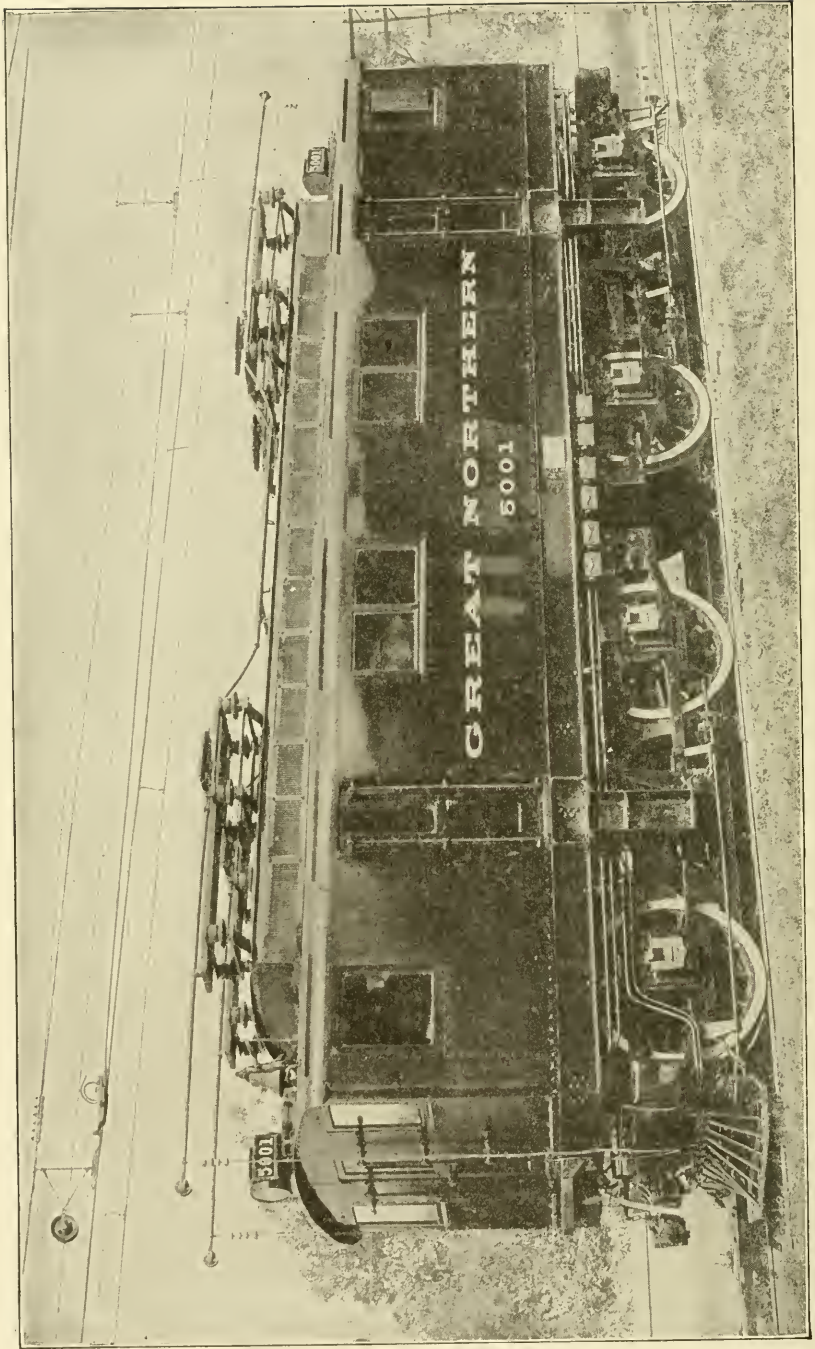

Fig. 266. Great Northern Cascade Tunnel Locomotive

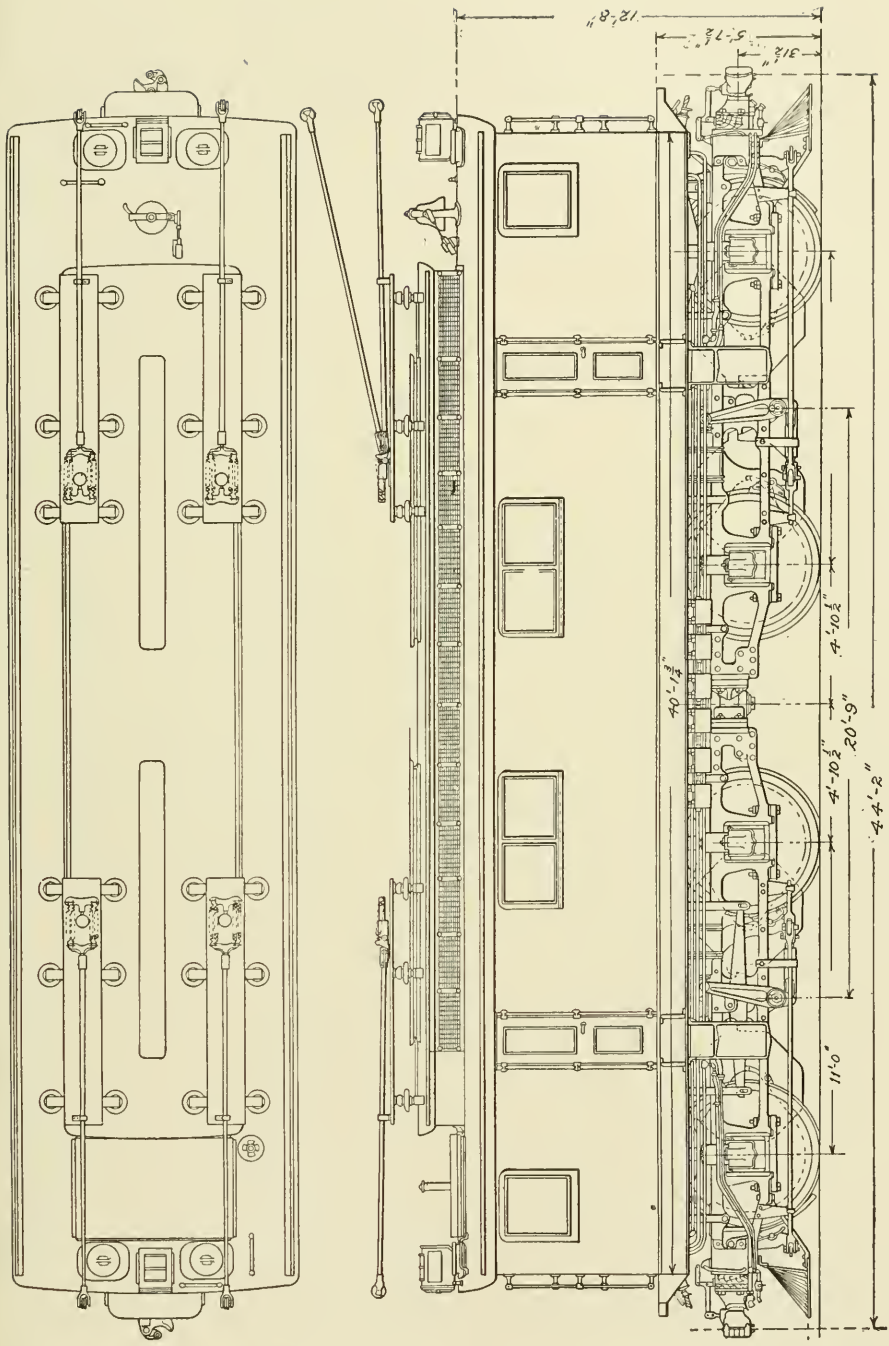

Fig. 267. Plan and Elevation of Great Northern Locomotive

note that if shunt, direct-current motors were used on railway cars, they would have the same effect on car operation.

Great Northern Locomotive.

Polyphase motors have been used on a commercial scale in railway work in this country only with the Cascade tunnel equipment of the Great Northern Railroad. The principal interest in the locomotive here used is in the control system. The motors are 500-volt, three-phase, induction motors with stationary primary winding. The secondary or armature is provided with slip rings for the insertion of secondary regulating resistance to change the speed. The motors are cooled by forced ventilation, air being supplied by a large blower. The motors are hung from the axles as in the case of smaller cars, but driving gears are mounted on each end of the motor axle in this case.

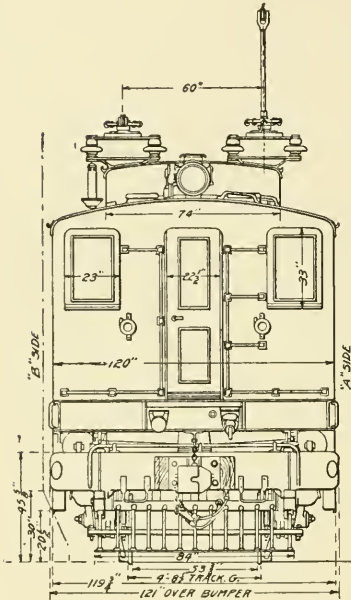

Fig. 268. End View of Great Northern Locomotive

The motors are supplied with current from an overhead trolley circuit, the voltage of which is 6,000. This voltage is reduced by means of transformers carried on the locomotive. Two trolleys are necessary in this case as the circuit is three-phase. The third conductor necessary is furnished by the rails. The current is controlled by contactors, as in the other locomotives described. In this case, however, most of the contactors are used to cut out in steps the three-phase secondary resistance. Figs. 266, 267, and 268 show clearly the general construction of this locomotive.

DISTRIBUTION OF POWER FOR HEAVY TRACTION

For direct-current railways the third rail must be used as it would be impossible to get the necessarily large current into the cars by any other means. Heavy overhead conductors are occasionally used under peculiar circumstances, but they are clumsy and

expensive to maintain. Examples of such construction are found in the yards of the New York Central and the Pennsylvania New York terminals. The third rail is supplied with current from copper feeders which are, in turn, connected with the substations. The latter obtain power from the alternating current, three-phase transmission line. This system is reliable and satisfactory. It is clumsy and expensive on account of the large amount of copper and iron needed in the low-tension circuit. The complicated arrangement of rails in yards is objectionable and must sometimes be replaced by one employing overhead conductors.

The alternating-current system has an advantage in that a high voltage may be used and the current correspondingly reduced. This current may be taken into the cars through an overhead contact and the live circuit is thus out of the way. As an example of the difference in the current in two comparable cases, take the following. What current is required by an electric locomotive developing 1,500 h. p. (a) at 600 volts, d. c., and (b) at 11,000 volts, a. c.? Assuming the efficiency at 85 per cent in both cases, we have, for (a) 2,193 amperes, and for (b) 120 amperes.

The high voltage on the overhead conductor permits the use of a smaller conductor. This size of conductor for a given percentage loss in the line varies inversely as the square of the voltage. For example, in the case cited above, the a. c. voltage is 11,000 and the d. c., 600. The ratio of the two is 18.33 and the square of this ratio is 336. It is quite evident that from the standpoint of line cost there is everything in favor of the high-pressure alternating current. The student will naturally ask, "Why is there any difference of opinion among engineers as to the best system to use?"

Brief Comparison of Systems. As has been pointed out, there are three commercialized systems available for heavy traction. There are others in the pre-commercial stage but these need not be considered at present. The available systems are:

1. Direct current, 600 or 1,200 volts with a. c. power transmission.
2. Alternating current, single phase.
3. Alternating current, polyphase

(1) The direct-current system employs a motor which, through long evolution, has been brought to a high state of perfection. The

motor is light, fairly efficient and has characteristics well adapted to traction.

The direct current is not adapted to efficient transmission, hence line losses are large and the conductors are expensive. Alternating-current power stations with three-phase transmission permit of the efficient transmission of power part way but this involves the use of rotary converters with consequent expense for equipment, attendance, and maintenance. The third-rail distribution is clumsy but reliable.

(2) The alternating-current system comprises a highly efficient transmission system and the current may be taken into the cars at line voltage or may be lowered in stationary transformers in substations, requiring no attendance. On the cars the control of motor speed is simple and efficient as the voltage can be varied by means of taps at several points in the transformer winding. The characteristics of the motor are similar to those of the direct-current motor.

The motor used in this system is new and has, therefore, not been through the evolution which has resulted in the perfection of the direct-current motor. The alternating-current motor is heavy and requires, for this reason, heavy trucks, etc. For a given weight a locomotive equipped with a. c. motors has less power than one equipped with d. c. motors.

The overhead construction requires careful insulation and maintenance and is not inherently as rugged as the third rail. It appears, however, to give entire satisfaction.

(3) The polyphase system employs the induction motor which is in a high state of development. It is the lightest of all traction motors for its output. It has, however, constant-speed characteristics which render it inefficient during the period of acceleration. The constant-speed characteristics, on the other hand, make it possible to return power to the line on down grades. From the power transmission standpoint, the polyphase system is even better than the single-phase system for it is most economical of line copper. This system requires the use of two overhead conductors and two sets of collecting devices.

Conclusions. There is no one system which is adapted to all heavy traction. The New Haven Railroad electrification is regarded as a trunk-line proposition and transmission is, therefore, the most

important consideration. The New York Central electrification, on the other hand, is regarded as a terminal installation. High power and ruggedness are prime considerations. In the case of the St. Clair tunnel plant, the direct current was not used partly because of third-rail complications in the Grand Trunk division yards which are located at this point. These illustrations indicate that different considerations have different weights in each case.

APPENDIX

The wiring diagram given on the following page is for a modern Sprague-General Electric automatic control. Mention is made of this diagram on pages 65 and 67 of Part I. The automatic feature is described there. The plan differs from that of Fig. 57 in that the acceleration is automatically controlled. The resistance steps in this case are more gradual. The master controller is also somewhat different in that the reverse direction of the reverser is secured by a motion of the master controller handle in the opposite direction from that which produces forward motion.

Connections of Sprague-General Electric Multiple Unit Control System Type M with C-36-C Controllers, SB-17-54-A Contactor Box, Four Motors and Trolley.

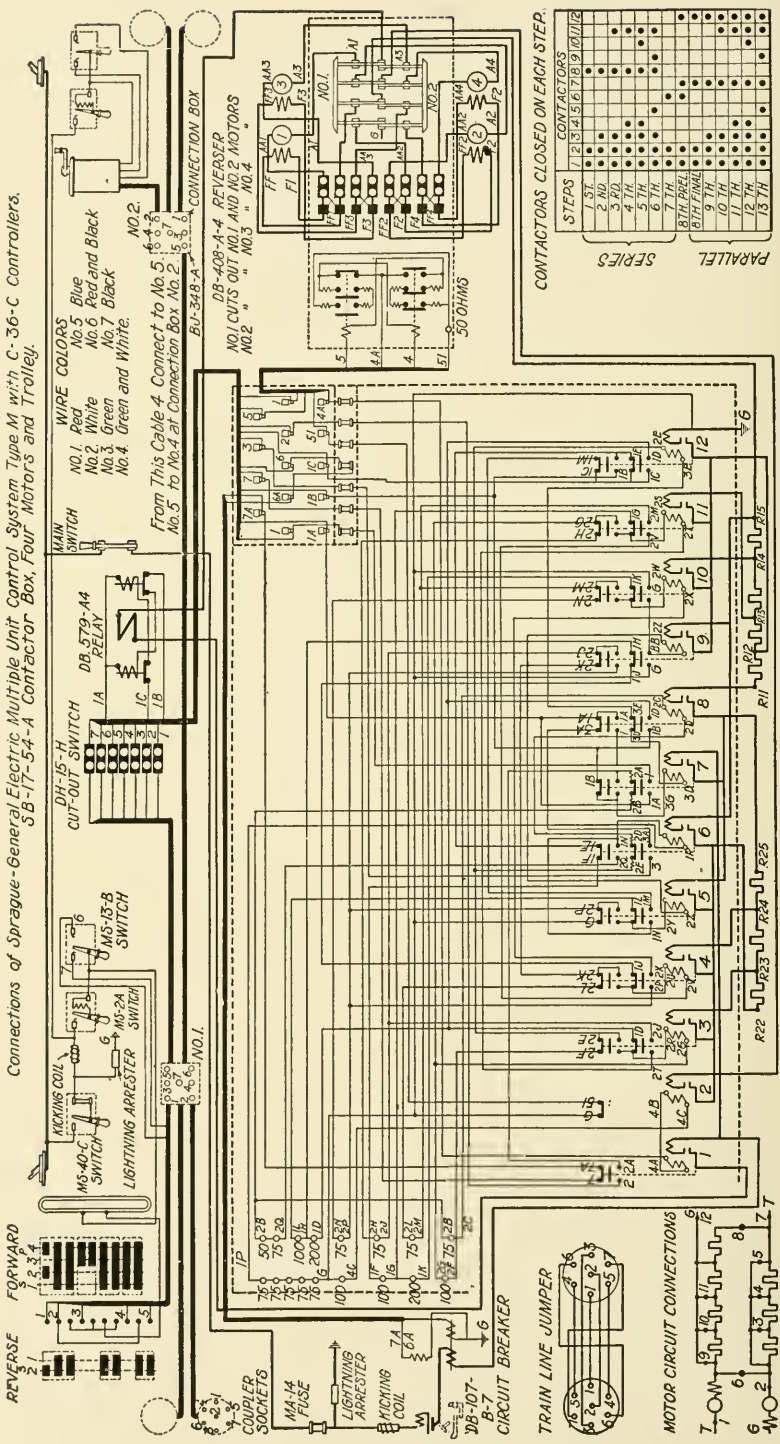

Fig. 269. Wiring Diagram for Sprague-General Electric Automatic Control

TRACKLESS TROLLEY TRACTION

Every new invention or new application of energy is born of necessity. In their effort to extend their line, electric traction companies have found a need for some means of transportation which is cheap and reliable, and which can be used on all kinds of roadways where traffic is so light that a large outlay of capital is not justified. This need has been particularly felt in European countries with the result that a new system has been developed to which has been given the name "Trackless Trolley".

UNIQUE FEATURES AND ADVANTAGES

Trackless Feature. As the name implies, this new system has no tracks, nor rails, the absence of this characteristic feature of a traction line allowing a certain radius of operation on both sides of the trolley wires by which the meeting, overtaking, and passing of other vehicles are possible.

Weight. The cars used are very light because it is not necessary to equip them with heavy storage batteries, gasoline motors, or other power plants which so materially increase the weight of automobiles and autobusses.

This saving, which amounts actually to one-half the weight of an automobile of the same capacity, is very important on heavy grades, and results in enabling trackless trolley cars to take grades as high as 15 per cent, which would be impossible for heavier vehicles. The lightness of the cars gives a much longer wear to the tires, the mileage being estimated at about double that for automobiles.

The control is as simple as on an electric truck and, on account of the absence of the complicated machinery essential to gasoline cars, the management is simpler. This makes it possible to hire untrained motormen and thus cut down operating expenses.

Roadways. Again, the characteristics of this system make feasible the installation of trolley lines along roads which are so

narrow or have such other objectionable features that it would be impossible, or at least prohibitively expensive, to lay the usual rails. A turn in the road around a sharp point presents great difficulties in track laying but is easily negotiated by the trackless trolley.

Mobility. As already mentioned, trackless trolley traction is especially to be recommended where the amount of traffic does not warrant the installation of a permanent railroad bed with rails, but where it is, nevertheless, of sufficient regularity to demand service at special intervals. Suppose a route is selected and a line installed which does not pay as it was estimated it would; in this case, the line may be abandoned and the whole overhead construction removed to other streets with very small outlay. As soon as traffic on any of these temporary lines has increased to a point which will justify changing to a regular electric street railway system, the roadbed can be prepared, the rails put in place, and the same overhead trolleys used.

On the other hand, when the trackless system is intended to be a permanent feature on account of the difficulties of installation of a regular system, and yet the amount of traffic demands increased facilities, two overhead systems may be installed in such a way that each car has its own electrical connection, thus avoiding any loss of time when cars meet.

Current Consumption. It is obvious that a larger amount of current will be demanded by trackless trolley cars than by the regular street cars, because of the greater amount of friction on the roadway, but this is partly compensated for by the use of lighter cars. The fact is that this item of larger power consumption is usually an unimportant one to operating companies on account of the low cost of electrical energy.

Applicability. Trackless trolley traction is, therefore, recommended: (1) In cities with insufficient traffic to warrant large capital outlay, for transportation between railroad depots and small cities, and for resorts, and other seasonal traffic; (2) as feeders to electric street railways; (3) in city streets where, either because of traffic or of the narrowness of streets, a fixed route is impossible; (4) in rural and interurban districts for transportation of persons and of farm produce.

SYSTEMS

Several trackless trolley systems have been developed in the last decade and are more or less used in different countries. These all have certain characteristics in common: such as running without rails; using two trolley wires, one acting as a return circuit to take the place of the rails in the ordinary track system; equipping cars with 4 more or less heavily rubber-tired wheels; using direct current with a voltage of 450 to 550. Only one system has been equipped with single-phase alternating current.

Schiemann System. The Schiemann System is used mostly in Germany with some installations in Norway, in Italy, and in France. The details of the system are as follows:

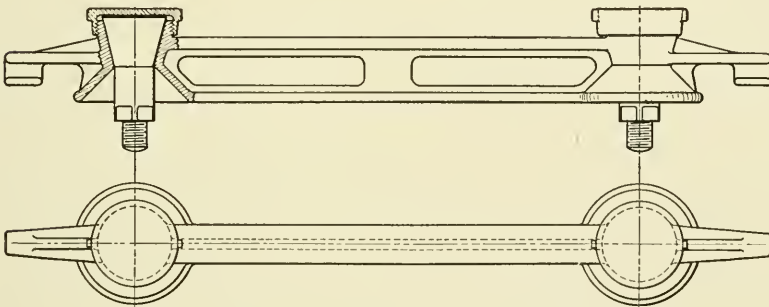

Fig. 1. Double Trolley Insulator Used in the Schiemann System

Trolley Wires. The trolley wires, which are put 17 to 20 feet above the ground and spaced 13 inches apart, are secured to clamps fastened to insulating plugs so that the current collector can make contact with the wires from below. The general arrangement of the insulators is shown in Fig. 1. Brackets or poles may be used for supporting the conductors in the same way as with common trolley wires.

Current-Collecting Device. The difficulty encountered with current-collecting devices lies in the fact that the car must be given a certain radius of action in order to meet or overtake other vehicles. The construction of the collector adopted in the system is shown in elevation and plan view, Fig. 2. The base *A* is fastened to the roof of the car and carries the rotary housing *B*. The contact pole *C* is pivoted to *B* and is pressed upward by a strong spring *D* against the

conductors. To the upper end of the pole *C* is fastened a forked casting *F* to which is hinged the rotatable sliding contact *G*. In some installations of this system one contact pole is used for each trolley wire with a separate sliding contact for each, while in others one pole only is provided, within which two cables run which divide at the top and are led to two sliding contacts as described. These contacts are shown in perspective in Fig. 3. When two cars of this system meet on one trolley circuit, the operator of one of the cars must take his contact pole from the wires until the other car has passed. The collector allows a possible side motion of about 10 feet on either side of the trolley wires.

Motors. In the Schiemann System the motor is arranged so that its axis is parallel to the longitudinal axis of the car. Its power is transmitted to the rear axle by the aid of a worm on the armature shaft which engages a worm gear on the axle. The wheels as well as all

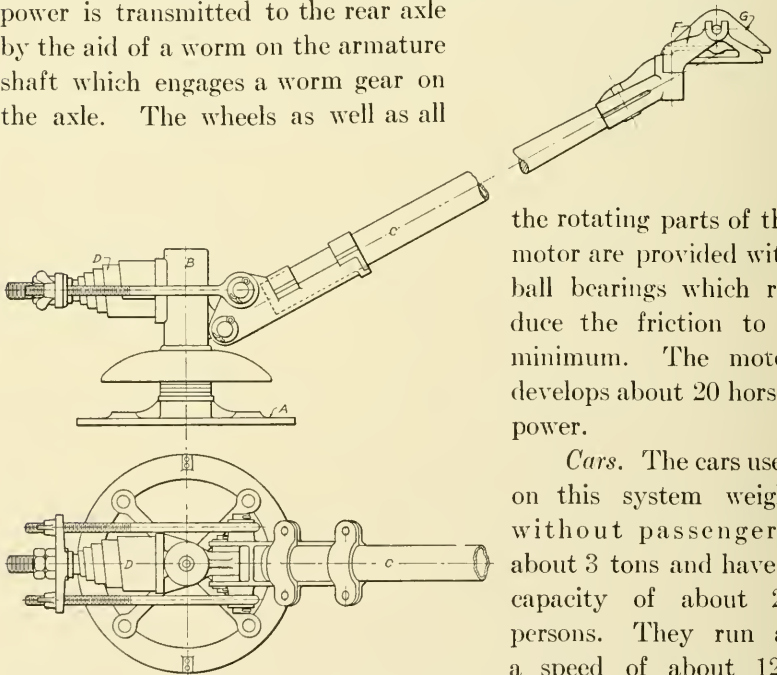

Fig. 2. Detailed Diagrams Showing Trolley Pole and Collector Device

the rotating parts of the motor are provided with ball bearings which reduce the friction to a minimum. The motor develops about 20 horsepower.

Cars. The cars used on this system weigh, without passengers, about 3 tons and have a capacity of about 20 persons. They run at a speed of about $12\frac{1}{2}$ miles per hour. The steering control is very

interesting, consisting of a device which allows both front and rear wheels to swing about their individual steering knuckles. The drive is applied to the rear wheels.

Special Installations. It is obvious that there would be some differences between individual installations, made necessary by the different requirements, but these differences are not worth mentioning. One of the first installations made of this system, an industrial trackless line in Wurzen, Germany, is shown in Fig. 4. Here we have not one car with motors but an individual motor car with trailers. Fig. 5 shows a plan view of such a trailer with the front and rear wheels both rotatable around their individual

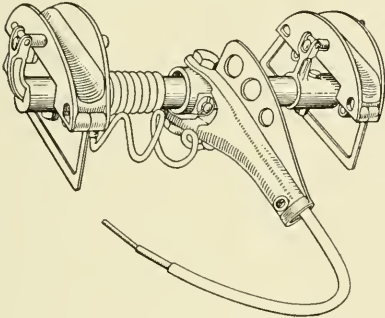

Fig. 3. Slide Contact of Schiemann Current Collector

knuckles. By means of such a device, a tractor with trailers is able to turn very sharp curves, and each trailer will run exactly in the tracks of the preceding one, as shown diagrammatically in Fig. 6.



Fig. 4. Industrial Trackless Trolley Line at Wurzen, Germany
Courtesy of Horseless Age

The steering of the system is effected automatically by having the tractor connected with the first trailer in a special way and each trailer similarly coupled to the following one. On the tractor is

located a handwheel by means of which this steering is effected. The motor controller has 9 different speeds, 4 with the 2 motors in series and 5 with them in parallel.

There is another installation of this system in Drammen, Norway, consisting of 2 lines with a total length of about $2\frac{1}{2}$ miles. It

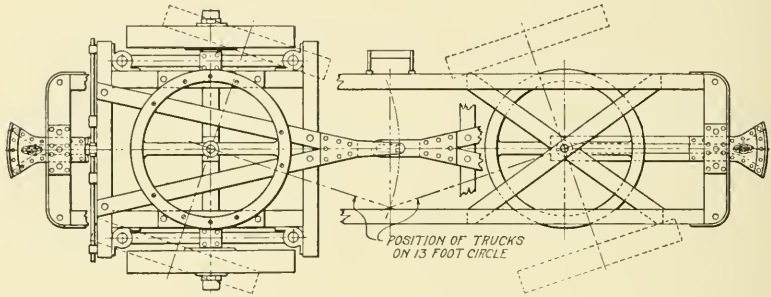

Fig. 5. Plan of Schiemann Trailer

was found that, even in a heavy snow, the cars operated very satisfactorily without any slipping of the wheels. It was even possible to connect as a trailer a sled carrying 10 passengers. The motor develops 15 to 22 horsepower, and the single trolley pole with forked contact is used.

Another installation is between the railroad depot of a suburban city of Hamburg and a residence district which is being developed.

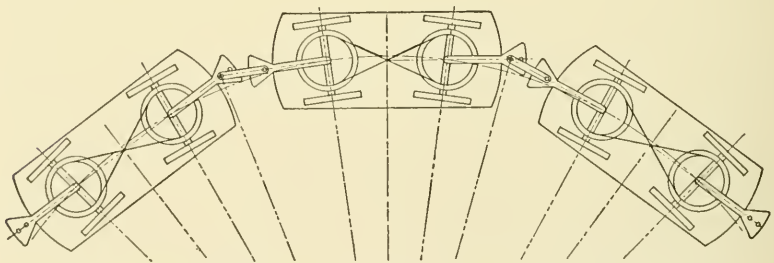

Fig. 6. Diagram Showing Steering Control of Schiemann Trackless Trolley Train

The route, which is about 2 miles long, is over the macadamized public highway. The equipment consists of a single car of 3.15 tons weight, while the motor develops 15 horsepower at 440 volts. The

line is considered temporary because regular electric street cars will be installed as soon as the traffic warrants.

Installations of this system are also found in Italy and France.

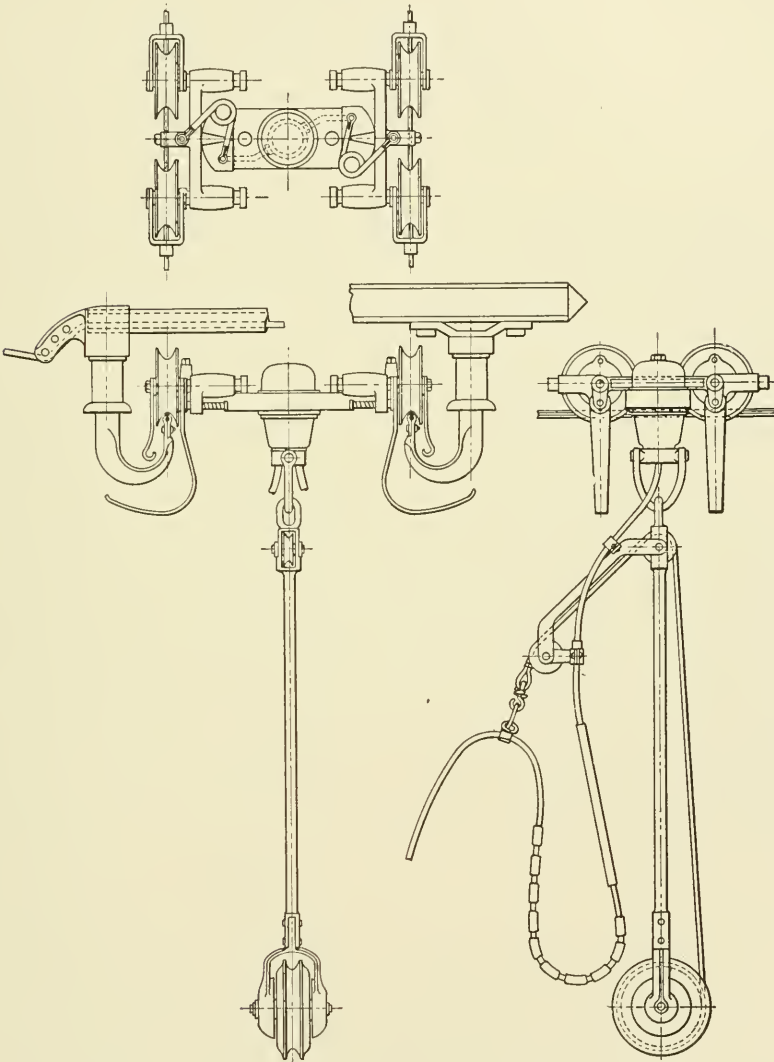

Fig. 7. Plan and Front and Side Elevation of Mercedes-Stoll Current Collector

Mercedes-Stoll System. The Mercedes-Stoll System originated in Austria and is used mostly in Austria-Hungary and Bohemia.

Trolley Wires. The trolley wires are spaced about 12 inches apart and are supported in such a way that the power can be taken off by a carriage running on top of the wires. This is the fundamental difference between the Schiemann System and the Mercedes-Stoli. The suspension of the wires does not offer any special features.

Current-Collecting Device. Fig. 7 shows very clearly the arrangement of the collector, and the details of its construction. Running

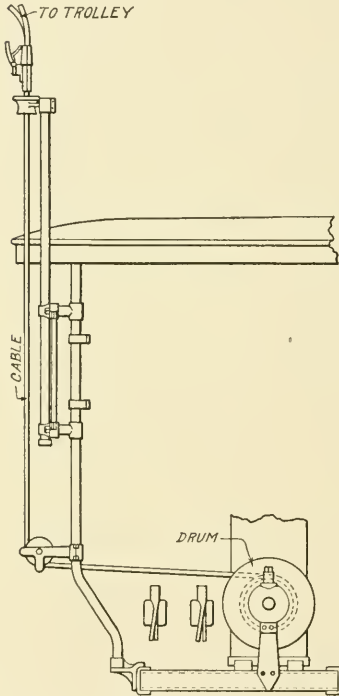

Fig. 8. Details of Trolley Cable Winding Drum

on top of the wires is a four-wheeled truck of very light construction, in the center of which is suspended, at a comparatively great distance, a heavy weight. By means of this weight the center of gravity is kept very low so that there is no danger of a derailment of the carriage. While experience has shown that such an accident is not liable to occur, nevertheless, as an additional precaution, safety hooks are arranged so as to act in case the wheels should leave the wires. The wheels of the carriage serve, of course, as collectors, and by the use of two wheels on each wire all sparking is eliminated. Connection between the trolley carriage and the car is established by means of a flexible cable. This cable is attached to a vertical pole on top of the car and to a drum mounted in the vestibule, Fig. 8; by means of stiff springs which operate this drum, the cable is kept under a certain tension and at the same time a large radius of action is provided. It is possible by this arrangement for the cars to run out of their way 30 to 35 feet on either side, thus using the whole width of the street and passing vehicles without difficulty. The cables are further provided with plugs by means of which the trolley carriage and cable may be detached from their cars. It is possible, therefore, if two cars meet on the same circuit, for

the plugs to be pulled out and the carriages exchanged, with but a loss of about ten to twenty seconds of time. It is sometimes not even necessary for the cars to stop, the cables being exchanged while the cars are running by virtue of their own momentum.

Motors. The motors of these cars are unique and very interesting, being entirely embedded in the wheels or, more properly, they themselves make up the wheels, for the field magnets of each motor are the hubs of the wheel and the armature rotates around them, Fig. 9. The motors are of the direct-current series-wound type, of about 20



Fig. 9. Four-Motored Vienna Trackless Trolley with Trailer

horsepower capacity, and the current is supplied to them through a hollow axle. Each motor is entirely enclosed, so that it is water- and dirt-proof. By this motor construction an economy of both space and power is effected and the cars run with high efficiency. The controllers are provided with 6 speeds, 3 with series-connected motors and 3 with parallel-connected, with 3 points additional for braking.

Cars. The cars are very light and are built of pressed steel. On account of the fact that the motors are in the wheels, the springs

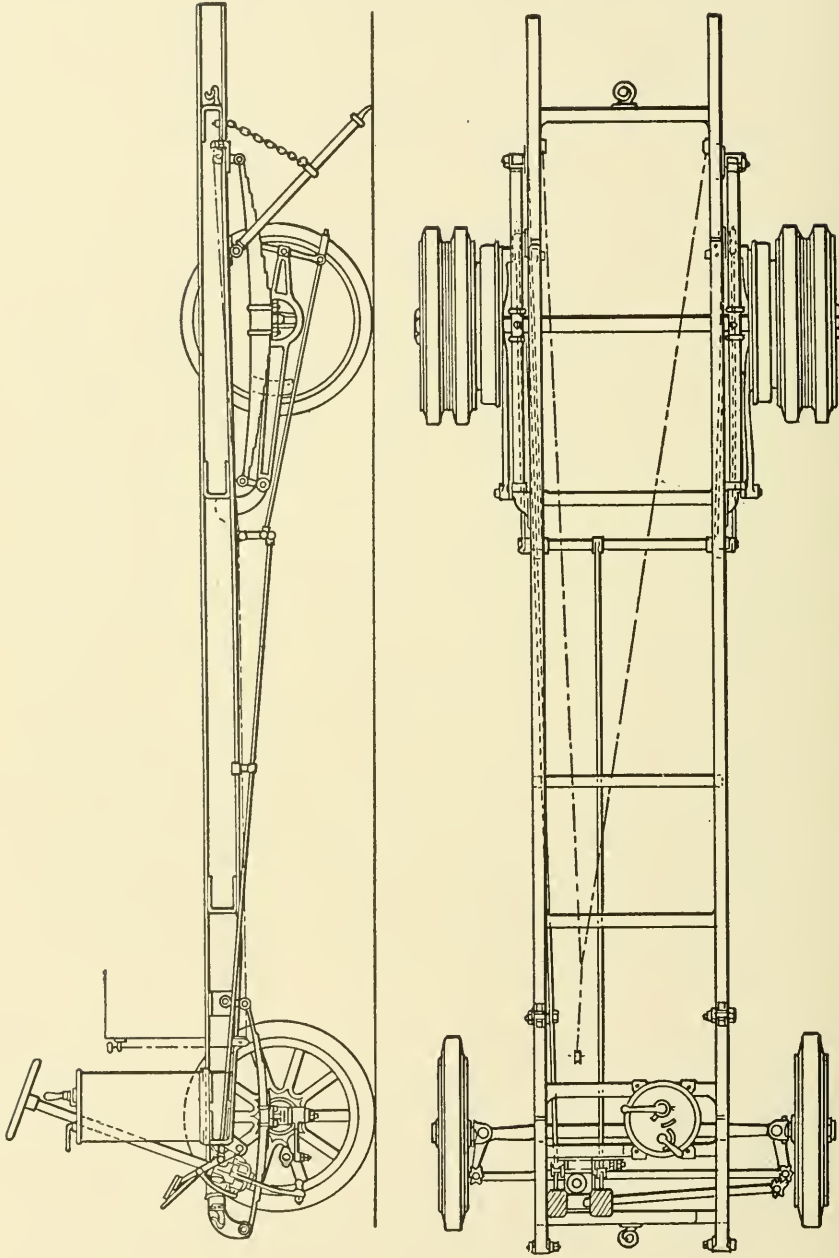

Fig. 10. Plan and Elevation of Mercedes Chassis. The Motors Are Mounted Inside the Double-Tired Rear Wheels

may be made very light and the total weight of a car reduced to less than 2 tons. Fig. 10 gives a clear idea of the construction of the chassis of these cars. Fig. 11 shows the application of the Mer-

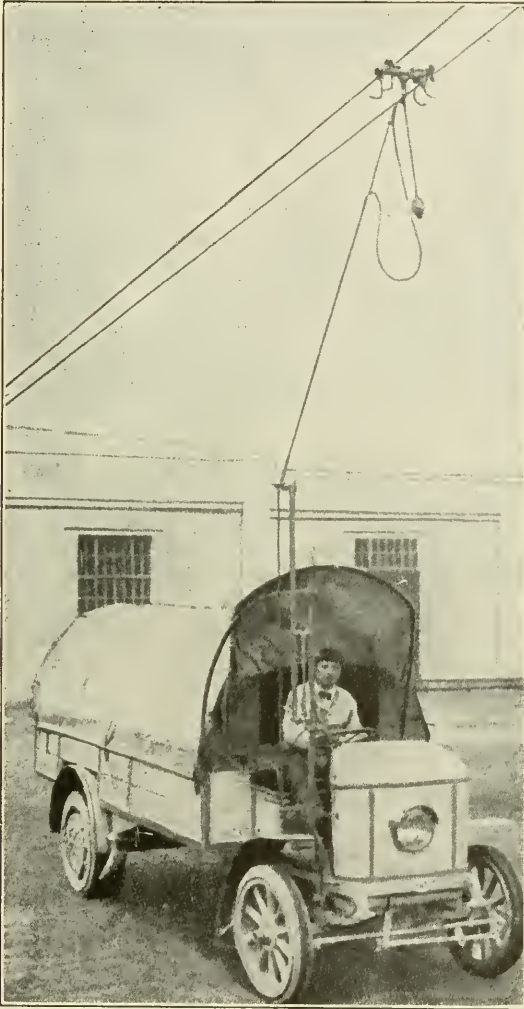

Fig. 11. Trackless Trolley Truck in Service in Vienna, Austria

cedes-Stoll system in the case of an electric truck which is performing very useful service.

Special Installations. A line built according to this system is

located in a suburb of Vienna, the length being about $1\frac{1}{2}$ miles. There are no level stretches, the steepest grade being 8.4 per cent and the least 2.81 per cent, and there are several sharp curves and sometimes very narrow roadways. Four wires are provided for the trolley in order to avoid the exchange of contacts. The power is provided by connecting the wires to the electric street railway circuit, the positive wire to the trolley, the negative wire to the rails. The rolling stock consists of four motor wagons, each with a capacity of 22 passengers, two 20-horsepower motors driving the rear wheels. The trolley cable is about 65 feet long, thus giving a large radius of action. Braking is effected by electricity and by foot brakes. The illumination of the car is by electric lights. On recommendation of the manufacturers, trials were made with four

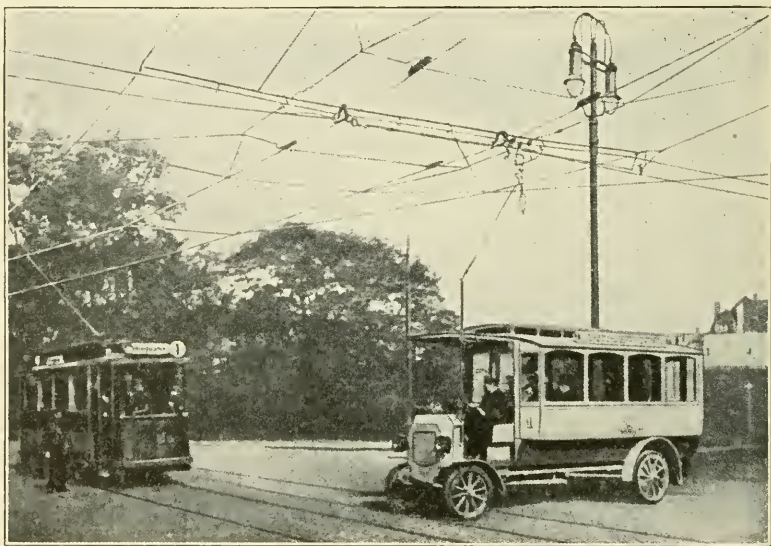

Fig. 12. A Bremen Electric Omnibus Line Crossing the Tracks of a Regular Car Line
Courtesy of Engineering News

motors each in one wheel, and a trailer attached to this car, Fig. 9. These trials were very satisfactory and the car has been put in regular service. There are many other installations in Austria-Hungary which are proving very satisfactory.

Koehler System. An installation according to the Koehler System has been recently put in operation in Bremen, Germany, and shows some interesting features, Fig. 12.

Trolley Wires. The essential difference between this system and others lies in the arrangement of the trolley wires, which are one above the other. The negative conductor is on top and 11 inches away from the positive conductor. One advantage of this construction is the very simple suspension.

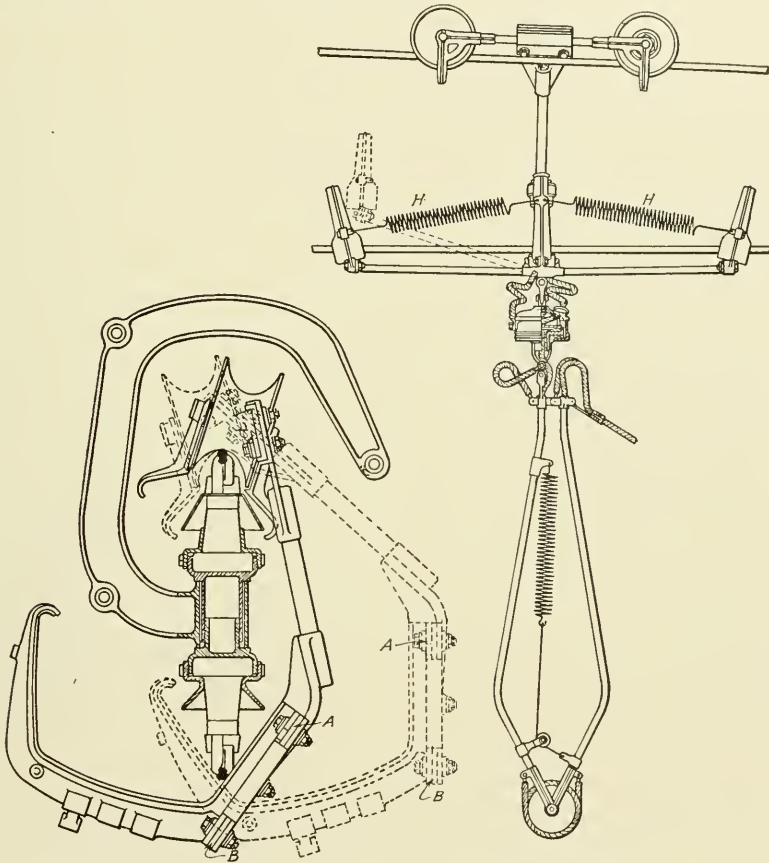

Fig. 13. Details of Trolley Suspension and Current Collector of the Koehler System
Courtesy of Engineering News

Current-Collecting Device. It is obvious that the collector must be of entirely different construction from that in any other system on account of this different arrangement of the wires. Fig. 13 shows the general construction. The first essential is, of course, that such a collector be light and at the same time capable of adjusting itself to side pulls. Furthermore, as with all the other systems,

there must be a flexible connection to the car with an automatic device by means of which the cable drum is controlled under varying conditions. The collector itself is a combination of the over-running

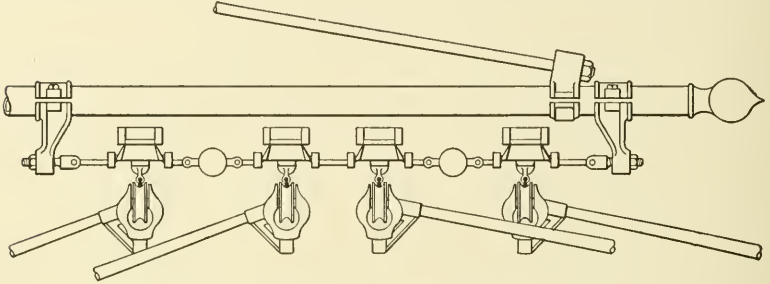

Fig. 14. Trolley Suspension Method for English Railless System

trolley and of the under-running bow features. On the negative conductor we have two trolley wheels 12 inches apart carrying a C-shaped arm to which is connected the aluminum bow collector for the positive wire. The upper and lower carriages are insulated

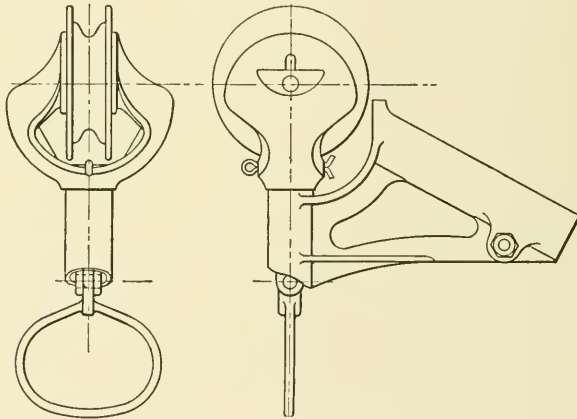

Fig. 15. Views of Trolley Pulley Showing Ring by Which Trolley Is Shifted

from one another at *A* and *B*, Fig. 13. The springs *H* exert a pressure of about $3\frac{1}{2}$ pounds against the conductors and allow a limited upward and downward motion of the bows. The whole device is free to move a considerable distance from side to side without any danger of damage. The weight of the collector is about 12 pounds. The cable is connected to the car by a spring-controlled cable drum, which keeps the cable tight.

Motor. The motive power consists of one direct-current series-wound motor which is geared to the back axle. It has a normal rating of 18 horsepower, but may be operated up to a maximum of 35 horsepower at 650 revolutions. The controller is of the ordinary drum type with 5 running steps and 2 braking steps. The maximum speed developed is 15 miles per hour.

Cars. The cars are 21 feet long by 7 feet wide and $10\frac{1}{2}$ feet



Fig. 16. Leeds Trackless Trolley Car. Guard Shifting Trolleys
Courtesy of Southern Electrician

high. The capacity of each is 20 passengers and the weight empty is 3.2 tons.

English Railless System. A railless traction system which has some rather unique features, has been lately developed in England. The system is very generally used, especially in Leeds and Bradford; installations are also under consideration in many other places.

Trolley Wires. Figs. 14 and 15 give the construction of the suspension and collection devices. Four wires of No. 0000 W. S. G. hard-drawn copper are provided, thus avoiding breaking contacts in case cars meet each other. The trolleys may be suspended by

poles or brackets, or fastened to houses as the case may be, the two positive wires being arranged inside and the two negative wires outside. Direct current at 525 volts is supplied to the motors.

Current-Collecting Device. The collector, which resembles the Schiemann, consists of two separate trolley poles on the ends of which the collectors are fastened. The trolley wheel swivel pin runs on ball bearings and carries a tail spindle terminating in a ring, as shown in Fig. 15. The object of this ring is to facilitate the

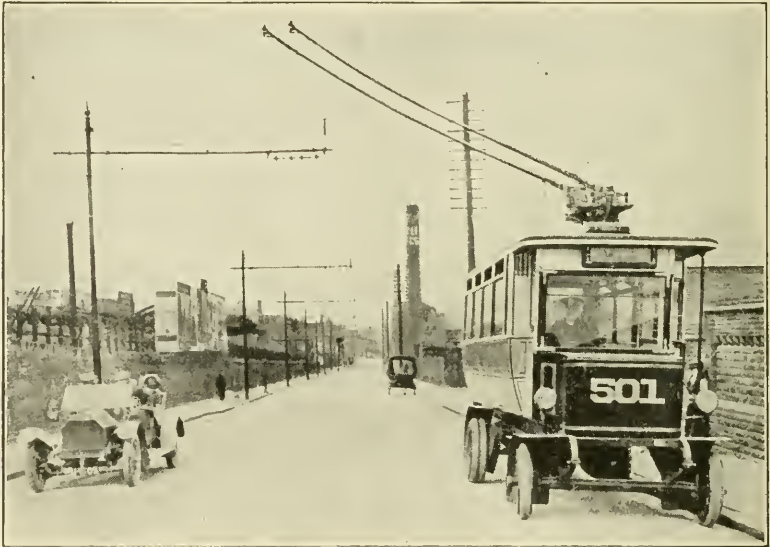

Fig. 17. View Showing How Trackless Trolley Can Draw Up to the Curb

placing of the trolley wheels on the overhead wires, as shown in Fig. 16. This arrangement allows the vehicle to run a distance of 15 feet on either side of the trolley wires.

Motors. A 20-horsepower motor drives each rear wheel by means of worm gearing and chain. Nine positions in the controller are provided, 5 for series connections and 4 for parallel connections. The motors run at 1,050 revolutions per minute, which is equivalent to 10 miles per hour.

Cars. The construction of the cars can easily be understood by studying Figs. 17, 18, 19, and 20. The entrance is in front, so that the motorman may act also as conductor. The wheels are fitted with solid rubber tires, one each for the front wheels and two

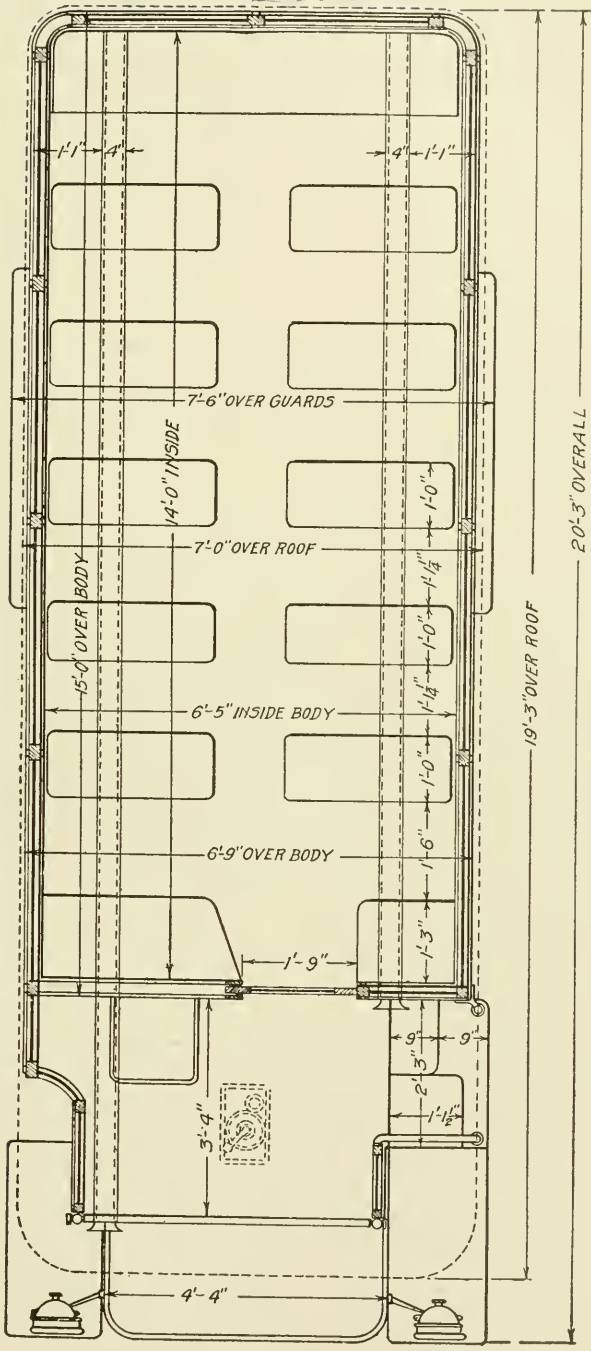
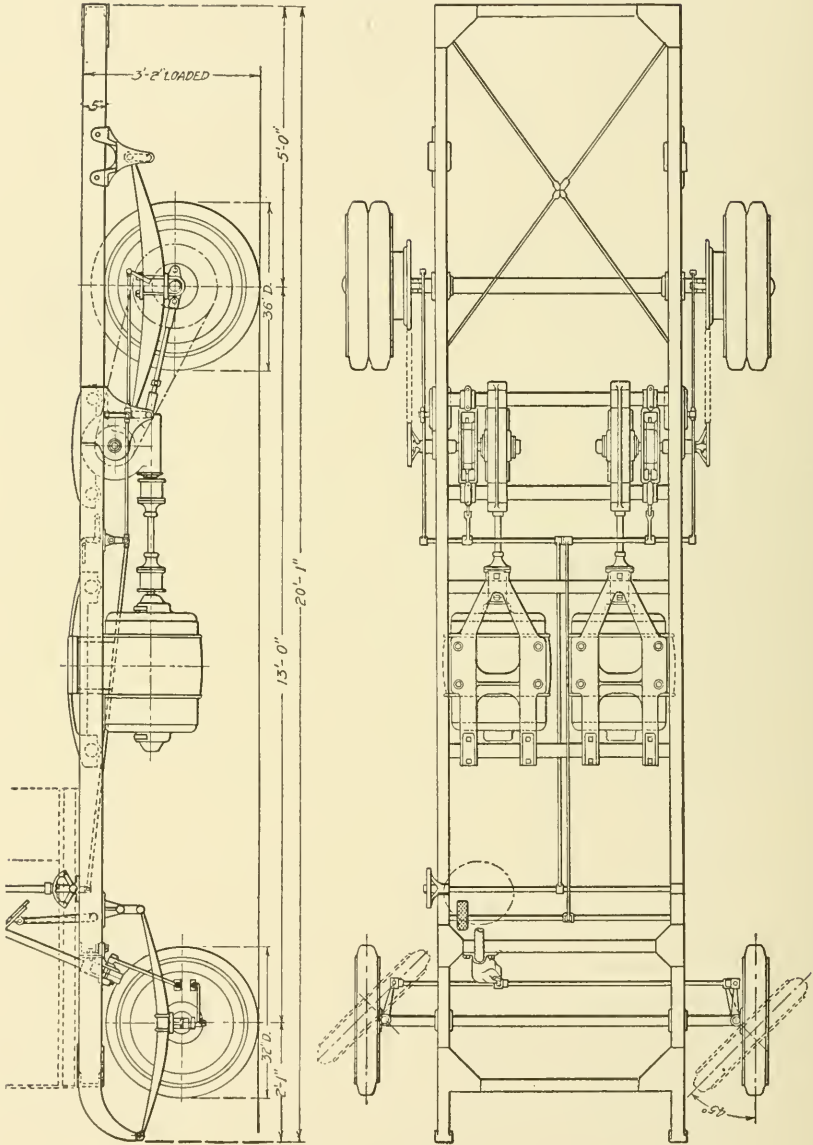

Fig. 18. Diagram Showing Interior Arrangement of Leeds Trackless Trolley Cars



Figs. 19 and 20. Elevation and Plan of Leeds Chassis Showing Motor Gearing and Steering Construction

each for the rear or driving wheels. Electric lights are provided for illumination.

Special Installations. The cars described above are running in Leeds. In Bradford a rear entrance is used and the cars are, in general appearance, not so pleasing as those in Leeds. Fig. 21 shows how such a vehicle overtakes and passes a freight truck. Other installations are contemplated in Aberdeen, Brighton, Edinburgh, Rotherham, and West Brom.



Fig. 21. Trackless Trolley Passing Traffic Team in a Crowded Thoroughfare

Filovia System. In Italy trackless trolley lines are very highly regarded, a total of more than 50 miles of line being operated to the entire satisfaction of the municipalities. In some cities subsidies are even paid for establishing such lines. A special system has been developed called the Filovia System, which differs from the others described in that, as a collector, a four-wheeled truck runs underneath the wires, held in place by a trolley pole in the usual manner. The possible deviation on either side of the direct route is 10 feet. The cars are usually equipped with two 15-horsepower motors and have a carrying capacity of 20 to 24 passengers.



Fig 22. Laurel Cañon Trackless Trolley (First in America) on Its Way up the Road

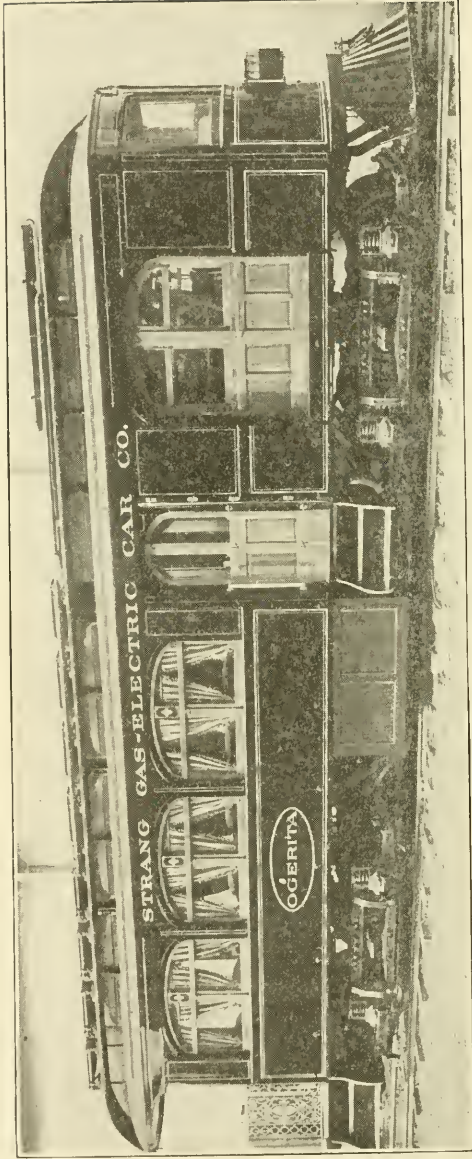

Fig. 23. Cars Passing in Laurel Cañon Drive. Car at Right Is Coasting with Trolleys Down

American Installations. America is just beginning to realize the possibilities and advantages of this means of transportation and will surely develop, before long, a system which will fit conditions.

The only installation worth mentioning is that of Los Angeles, California. Figs. 22 and 23 show some pictures of the cars. The line is about $1\frac{1}{2}$ miles long, runs through the Laurel Canon, and is reached via the Pacific Electric Line to Hollywood. The line operates at about 500 volts, the power being taken from the line of the above-named company. There are no turnouts on the overhead trolleys, for the whole road is up grade and the cars use the trolleys only when going uphill; they coast down on the return trip, regulating their speed with the brakes, of which there are two, operated separately by foot control. The trolley pole arrangement gives a latitude of about 11 feet on each side of the wires, each car is equipped with two motors of $7\frac{1}{2}$ horsepower each, and has a carrying capacity of 16 passengers. One man acts both as conductor and motorman for each car.

Considering the large areas and the scattered population of many districts, the possibilities for trackless trolley traction seem greater in the United States than in any other country. We may, therefore, expect that, in the near future, we shall find many installations of this kind here, with such changes from those already described as will be found necessary to satisfy special requirements.



THE STRANG GAS-ELECTRIC PASSENGER CAR

The Gasoline Engine Drives a Generator which Furnishes Current to the Motors on the Trucks.

SELF-PROPELLED RAILWAY CARS

The self-propelled railway car appears in the following types: (1) motor velocipedes; (2) section motor cars; (3) inspection cars; (4) locomotives for industrial or shop railways; (5) self-propelled, single-truck passenger coaches; (6) heavy, self-propelled, double-truck passenger coaches.

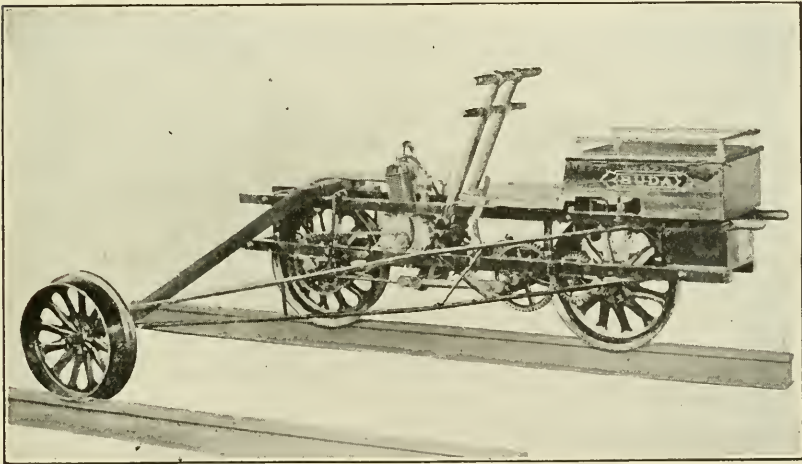

Fig. 1. Light Motor-Velocipede.

The railway motor repair car is no longer regarded as a luxury but has now become a good investment, as the time saved in going to and from the field of work amounts in a short time to more than the cost of the car and its operation. Moreover the laborers' energy, which was formerly lost in propelling the old-fashioned hand-cars, is now available for road work. The motor car has, therefore, become a permanent addition to the equipment of the section or bridge gang and track inspection department.

Motor Velocipedes. The lightest type of self-propelled railway car is the motor velocipede, for the use of signal maintainers, linemen, and others who have heretofore used hand-driven velocipedes. Fig. 1 is a good example of this type of car as built by the Buda Foundry & Mfg. Co., Chicago. It is driven by a $2\frac{1}{4}$ -H. P., air-cooled, single-cylinder engine. A peculiar feature of the engine is that the cylinder is made from a bar of solid steel, having its bore ground and piston accurately fitted, affording greater durability than would a cast-iron

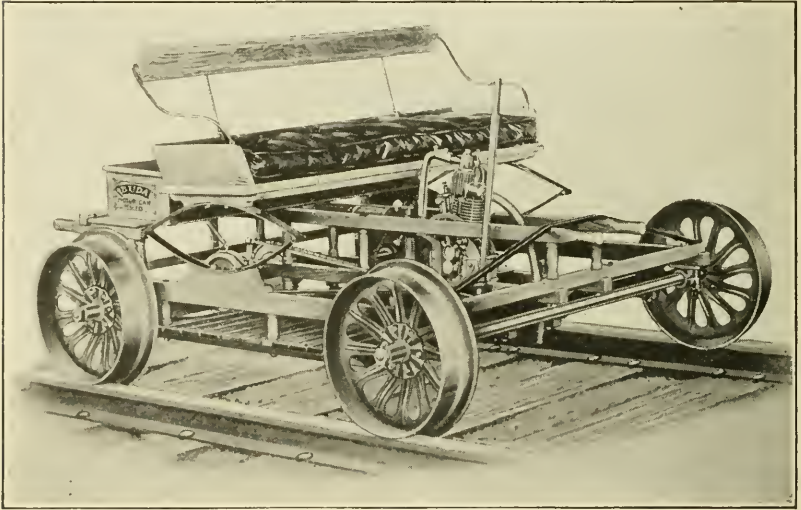

Fig. 2. Inspection Motor Car.

cylinder. Another feature of the engine is that the exhaust valve is made of nickel, which will withstand pitting and wear better than steel. The engine is lubricated by a sight-fed gravity lubricator.

The car is driven by means of a chain connecting a sprocket on the engine shaft with the front axle, which is provided with a friction device, which, in case of undue shock on the chain, will slip and avoid breaking the chain. Ignition is brought about by means of the dry cell and jump spark. The gasoline tank can hold sufficient gasoline for a two-hundred-mile run.

To do away with the necessity for cranking, and also to provide for such an exigency as the supply of gasoline giving out or accident to the engine, hand propulsion is provided. The car is started by

the hand lever, with the engine not operating on its own power. The hand-lever drive connects to the rear axle, which, after the car is under headway, is thrown out of gear; the switch is now thrown on and the spark lever adjusted to desired speed. The switch controlling the ignition is inside the tool-box. If the operator wishes to leave the car, he turns off the switch, locks the tool-box, and the engine cannot be

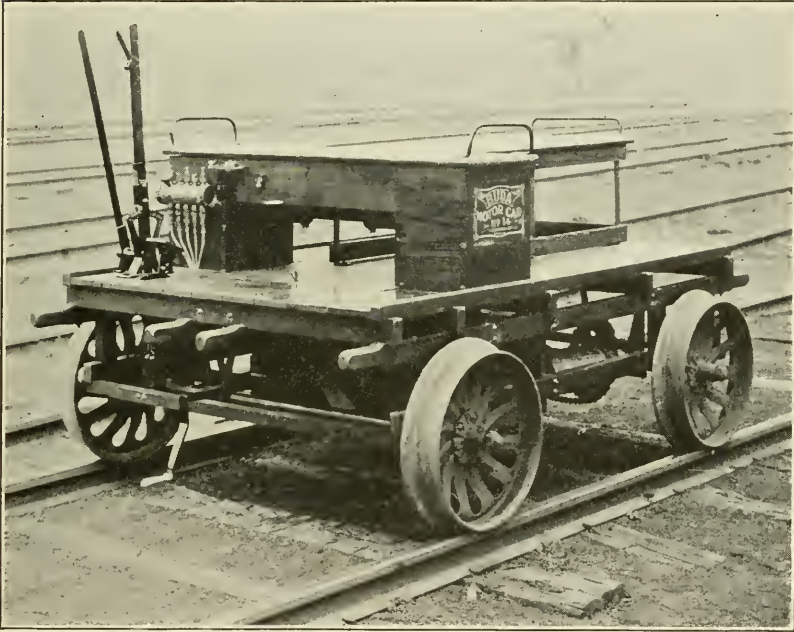

Fig. 3. Section Motor Car.

started until the tool-box is unlocked. The velocipede type of car is made to accommodate one, two, or three persons.

Inspection Motor Cars. A car of this type must be light and speedy. It differs from the motor velocipede already described, in that the engine is started by cranking, and in that the car is started or stopped by throwing a clutch in or out, as in an ordinary automobile. Fig. 2 shows an inspection car of this type. The hand lever at the front operates the clutch. A foot pedal operates a band brake on the rear axle.

Section Motor Cars. This type of car is intended to carry seven or eight men and their tools. Fig. 3 shows a car of this type. It is equipped with a 10-H. P., two-cylinder opposed gasoline engine, air-cooled and started by cranking, the crank being shown at the front of the cut. Various types of drive are employed, including friction disks, chain, and direct shaft and gear drive, although chain drive is probably most general.

Transmission and drive are arranged so that as high a speed may be obtained on the reverse as in going forward. This does away with the necessity of taking the car off the track and turning it around

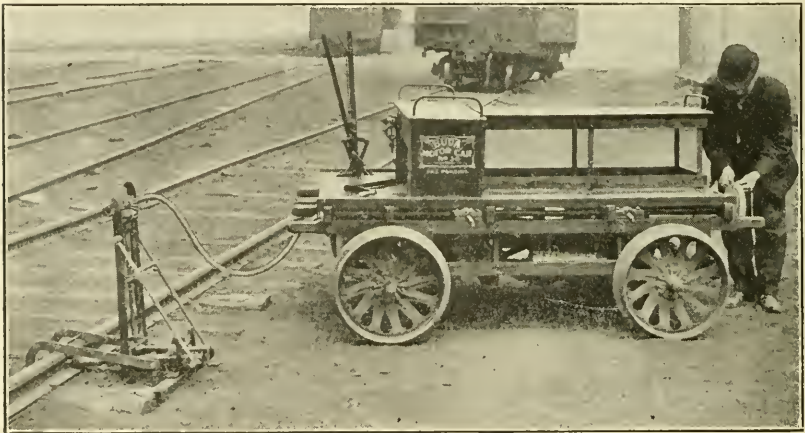
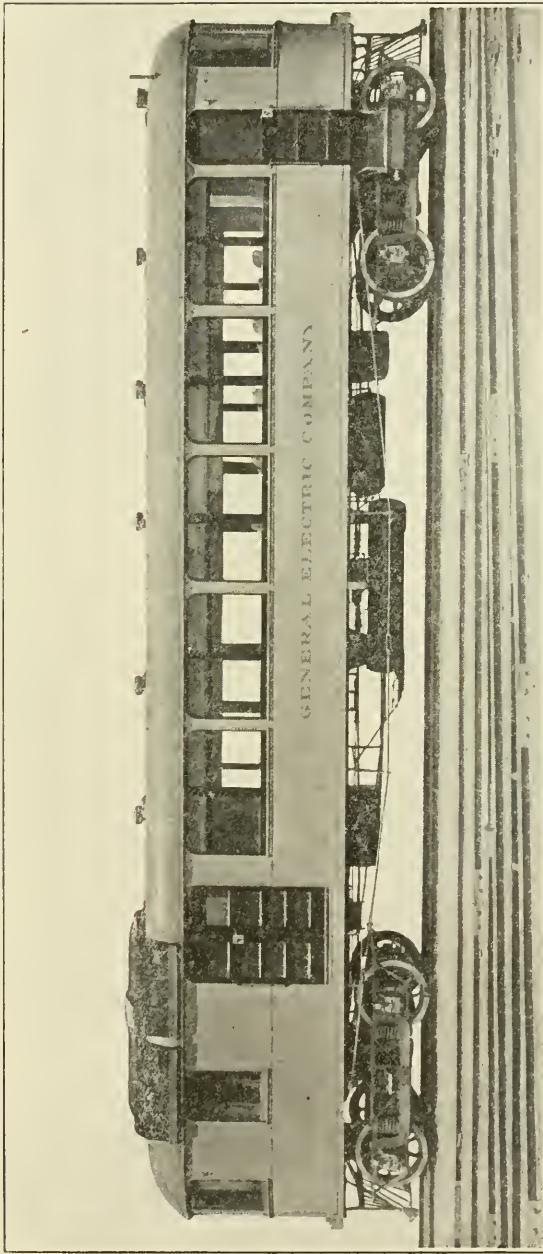

Fig. 4. Bridge-Gang Car with Power Attachment.

when it is desired to change direction. The cut shows the speed-changing and reverse lever of automobile type, and brake lever at the side of the car. The multiple-feed, sight-feed, gravity lubricator is shown at the front of the car.

Section or Bridge Gang Car with Power Attachment. Fig. 4 shows a car, similar in construction to the section car just described, but considerably heavier, designed for the use of section or bridge gangs. Mounted lengthwise under the car, and extending beyond the ends, are two shafts connected to the engine and provided with Morse taper shanks. These shafts are connected by bevel gears to two other shafts similarly tapered, which run across the car. These



A GASOLINE-ELECTRIC MOTOR PASSENGER COACH

The Radiator Tubes for Cooling the Gasoline Engine May Be Seen on the Roof of the Car at the Left.

four shafts, driven by the engine, may be used for drilling holes in rails by operating through flexible or telescopic shafts. The power can also operate a wood or metal saw, and, in connection with a small auxiliary air compressor or electric generator, it can operate riveting tools or other air or electric devices at a distance from any power plant other than the gasoline engine on the car. This car can therefore furnish the power to drill rails, bond wires, drill ties, and

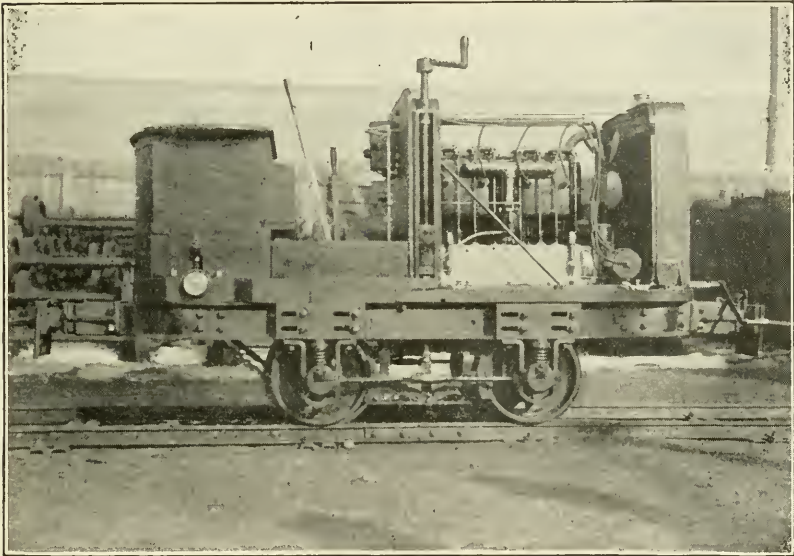

Fig. 5. Gasoline Industrial Locomotive.

to operate the machine for driving the screw spikes. It can spray paint on bridges or operate a concrete mixer. It can drive drills for drilling girders or for boring wood timbers, it being possible to run eight tools at one time.

Gasoline Locomotives for Industrial Railways. Most large industrial plants are provided with so-called *industrial railways*, these being narrow-gauge tracks with light cars usually pushed by hand. These cars are used in transferring material of various kinds from one part of the works to another, and are also used in such work as road building, excavating, hauling of cement, pig iron, coal, ashes, etc.

Fig. 5 shows a gasoline locomotive designed to haul ten loaded cars (tonnage 25), at a speed of eight to twelve miles an hour. The locomotive shown is a type built by the Ernst Wiener Co., New York. The engine of this locomotive is a four-cylinder, water-cooled, four-

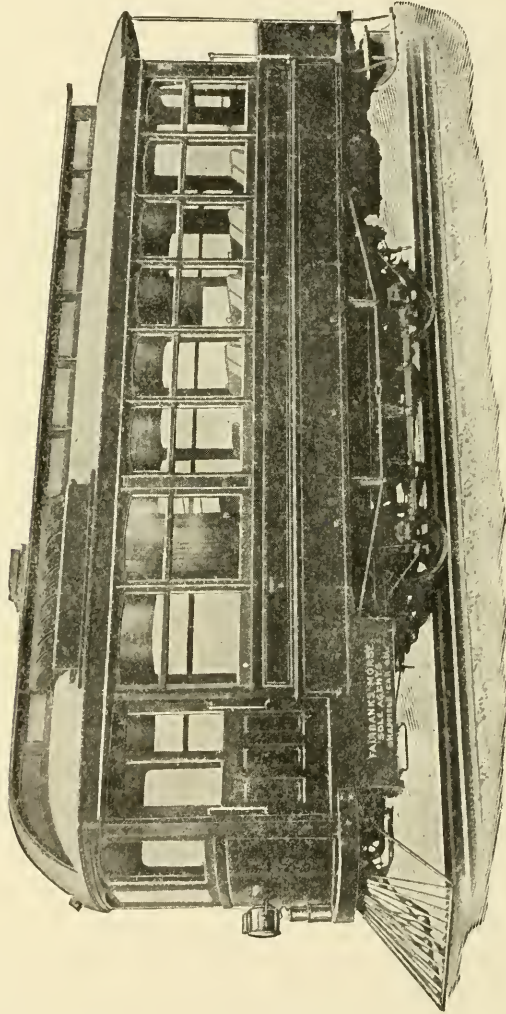

Fig. 6. Single-Truck Gasoline Passenger Motor Car.
Fairbanks-Morse Co., Chicago.

cycle, gasoline engine, with cylinders cast in pairs and standing vertically. Ignition is of the storage battery and magneto type, arranged for two sets of spark plugs. A radiator of the automobile type is at the front of the locomotive.

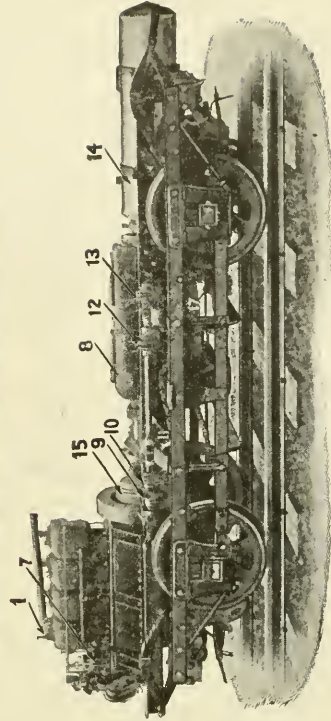
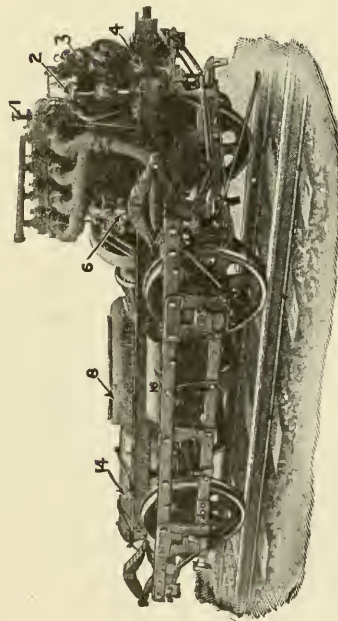
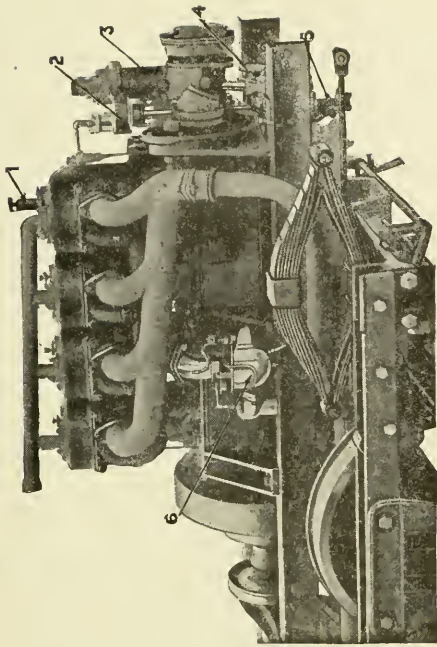
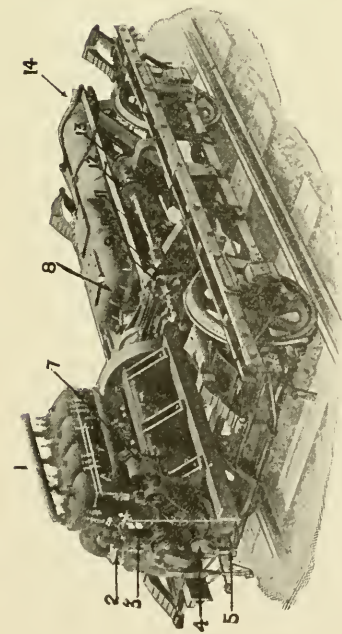

Fig. 7. Engine and Transmission, Fairbanks-Morse Gasoline Motor Car. 1 Cartridge Starting Device; 2 Commutator; 3 Air Compressor; 4 Hand-Starting Ratchet; 5 Oil Pump; 6 Carbureter; 7 Magneto; 8 Transmission; 9 Master-Clutch Cam; 10 Transmission-Brake Cam; 11 Control Shaft; 12 Slow-Speed Cam; 13 High- and Intermediate-Speed Cam; 14 Gasoline Tank (50 Gallons) 15 Master Clutch; 16 Muffler; 17 Air Cylinder.

Light Single-Truck Railway Motor Cars. Where the passenger traffic is small or irregular on branch lines of steam railways, and on street railway lines operating under similar conditions, it has frequently been a problem incapable of solution to provide a service

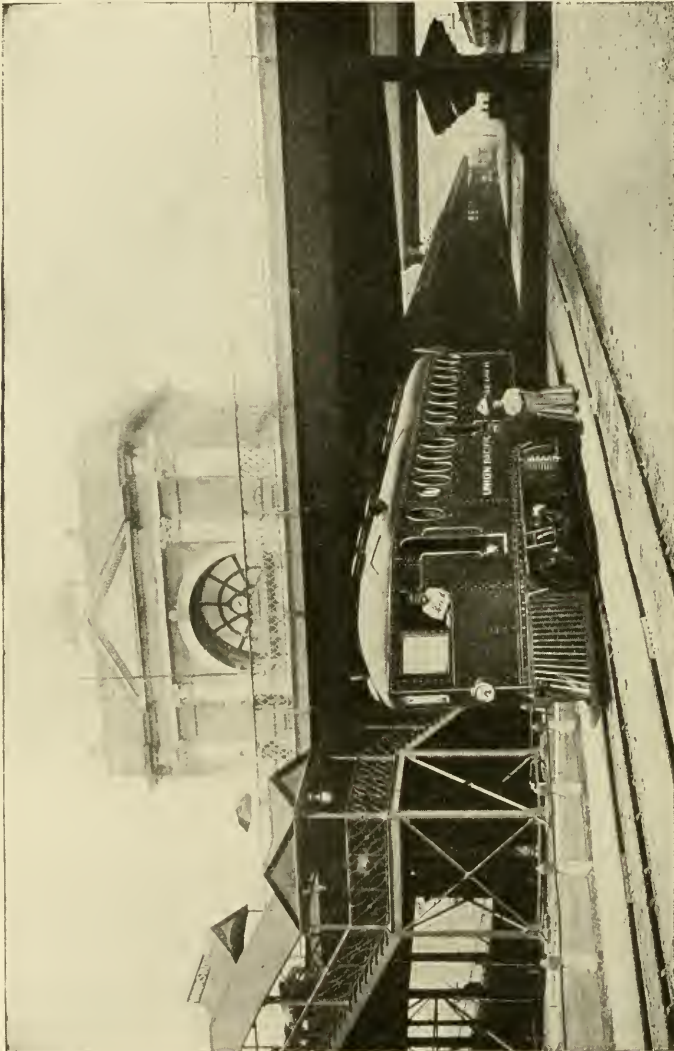

Fig. 8 Exterior View of McKeen Gasoline Passenger Motor Car.
McKeen Motor Car Co., Omaha, Neb.

that would pay expenses. In many cases, the gasoline-driven motor car has solved this problem, and it is likely that it will come into widespread use in this field.

Fig. 6 shows a single-truck gasoline motor car capable of seating twenty-three people in the passenger compartment, and with room for several additional passengers and baggage in the engine compartment. The car shown is built by the Fairbanks-Morse Co., Chicago, and is single-truck, with an over-all length of 30 ft. 3 in., the length of the body being 26 ft. 3 in.

Fig. 7 gives several views of the power plant of this car. The prime mover is a 50-H. P., water-cooled, four-cycle, gasoline engine. Ignition is by means of storage batteries with spark-coil and magneto, using a double set of spark-plugs. The engine is started by means

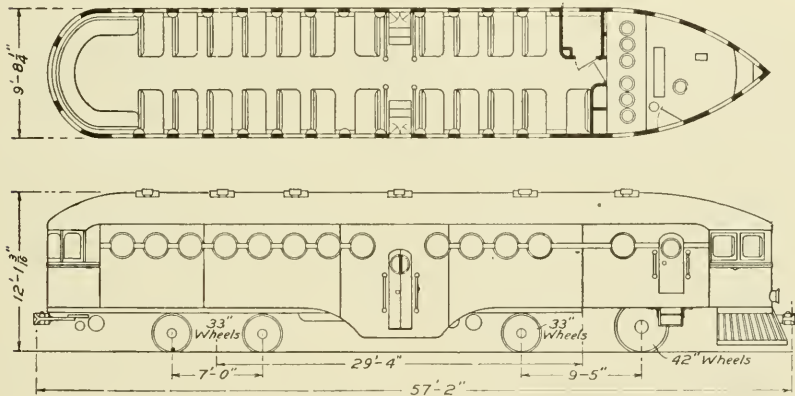

Fig. 9. Plan and Elevation of McKen Motor Passenger Car.

of a cartridge, which is exploded in one cylinder to give an initial pressure for turning the engine over. An auxiliary hand-turning arrangement is provided for turning over the engine without actually starting it. The transmission is of the sliding-gear type with three speeds in each direction. The transmission shafts run in roller bearings and the drive is double roller chain, one chain connecting to each axle.

Transmission-gear changes are controlled by means of a hand-wheel which shifts the gears, and controls a master clutch through cams on a side shaft running parallel to the transmission. The gears and master clutch are all interlocked in such a way that there is no possibility of two gears being engaged at the same time, none of the gear changes being made when the master clutch is in engage-

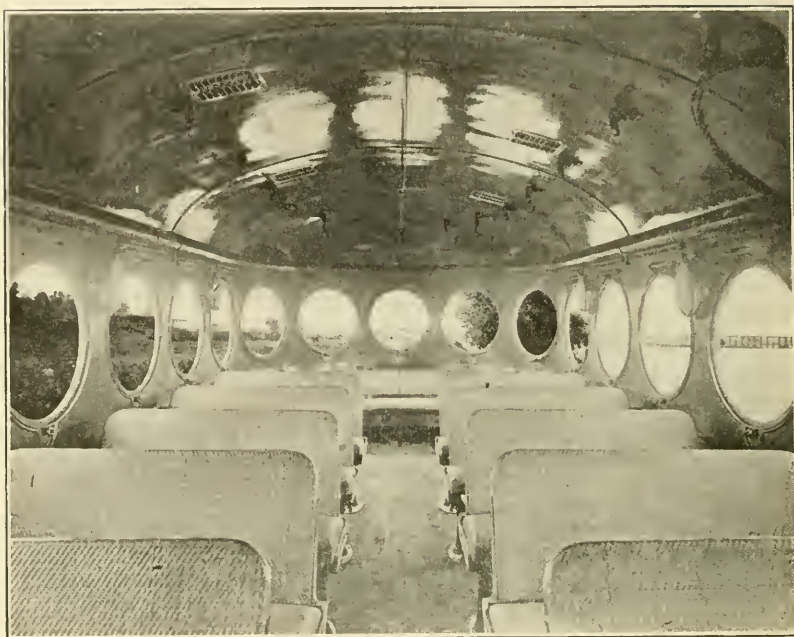

Fig. 10. Interior View of McKean Passenger Motor Car.

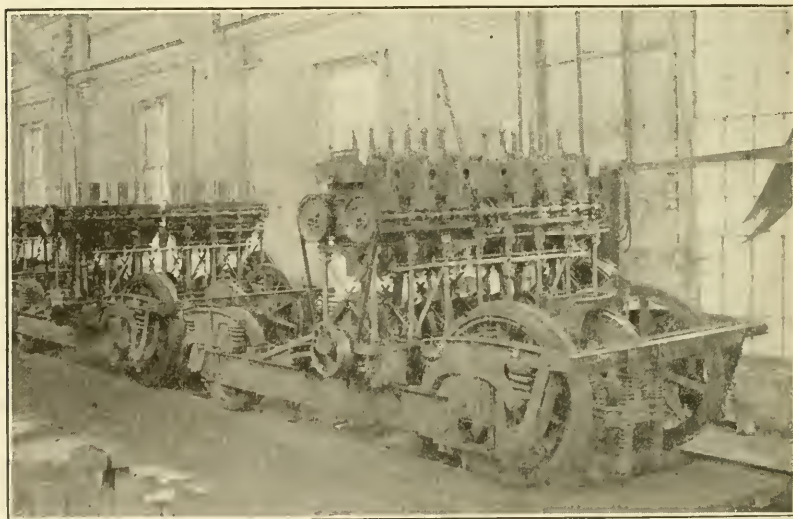

Fig. 11. Front Trucks of McKean Gasoline Motor Car Assembled with Engine.

ment. The car is equipped with an air-compressor mounted on the engine shaft and operating brakes on all four wheels, and is also fitted with a ratchet hand-wheel for hand operation of the brakes.

Double-Truck Gasoline Railway Motor Cars. A heavier type of car than the one just described, and intended for steam branch-line and interurban service, is made by the McKean Motor Car Co. of Omaha, Neb. Fig. 8 is an exterior view of this car as it appears in daily service between Omaha and Valley, Neb. Fig. 9 shows the car in plan and elevation. It will be noticed that the exterior lines present some novel features. The front end is wedge-shaped, the rear end is semi-circular, the roof is semi-elliptic, and the windows are round, resembling port-holes. The side entrance is also a distinguishing feature. The standard car is fifty-five feet long, of which length the engine-room and operator's compartment occupies twelve feet at the front end, leaving a seating capacity for seventy-five persons. The wedge-shaped front end has been adopted on account of its offering less resistance to the air, and consequently bringing about a saving in gasoline.

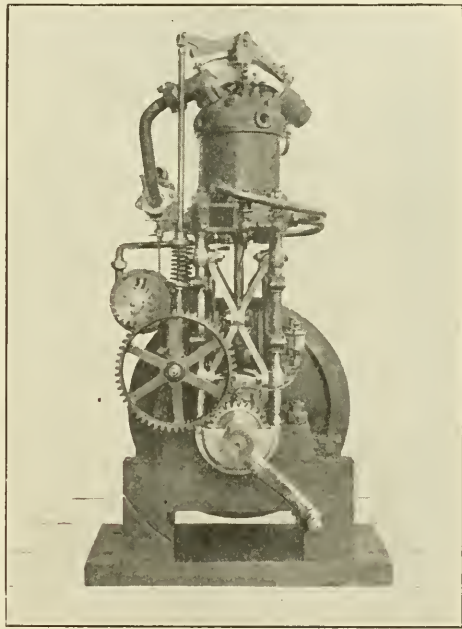

Fig. 12. Independent Auxiliary Gasoline-Driven Air Compressor.

As a result of comparisons of the wedge-shaped car with the ordinary blunt car in the matter of power required, it has been determined that, at high speed, the wedge-shaped car will use 40% less gasoline.

The round windows permit the utilization of the car side as a combination plate and trussed girder, thus adding to the strength of the car, and at the same time making a pleasing view to the eye.

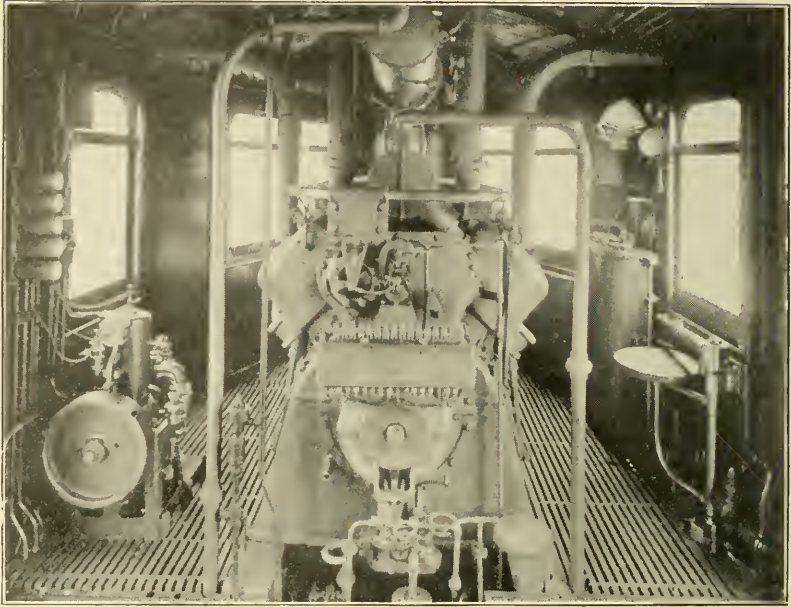

Fig. 13 Interior of Cab of General Electric Gas-Electric Car.

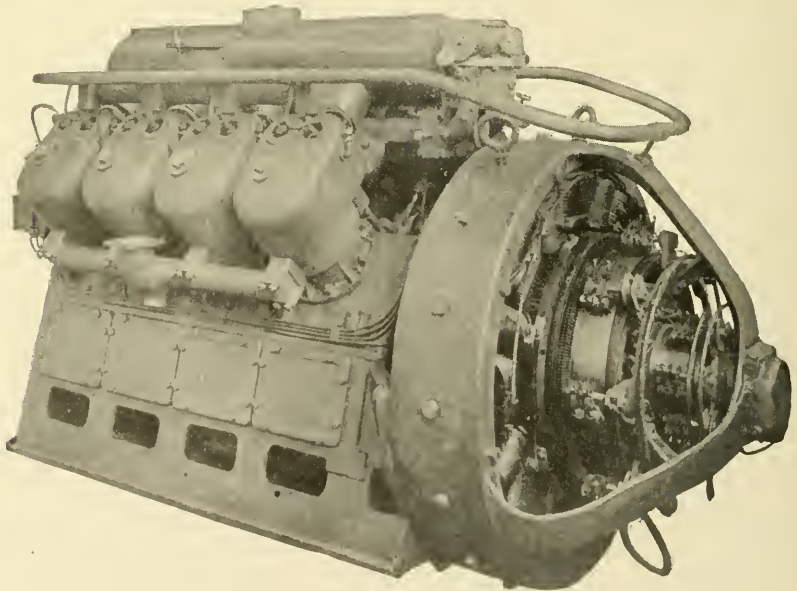

Fig. 14. Gas Engine and Generator of Gas-Electric Car.

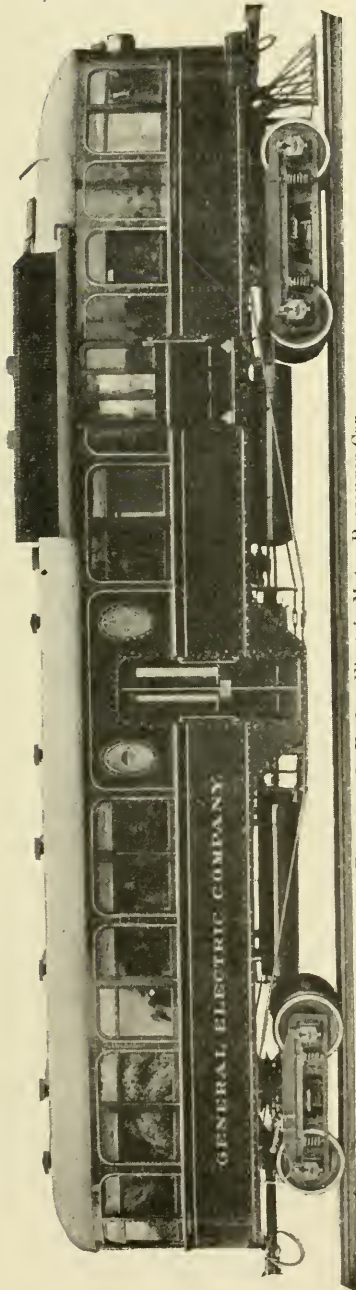

Fig. 15. G. E. Gas-Electric Motor Passenger Car.

This is shown in Fig. 10, which gives an interior view of the car. The side door facilitates quick entrance and exit, and the omission of end doors gives the car greater strength to resist telescoping in case of collision, affording also an exit in case of such accident.

The car is lower by two feet than ordinary coaches, but better ventilation is secured by means of roof ventilators which exhaust the air by suction from the inside of the car, fresh air being taken in from the top of the car in front and delivered to the interior of the car at the floor line. This ventilation can be adjusted so as to secure a complete change of air every four minutes if desired. The heating of the car in cold weather is more than adequately accomplished by means of the water from the cylinder jackets of the engine, which is allowed to circulate through pipes placed along the sides of the car. The exhaust pipe may also be utilized when the weather is exceptionally severe.

The power is furnished by a six-cylinder gasoline engine with cylinders cast in sets of three, water-jacketed with $\frac{1}{8}$ -in. copper. Transmission is by means of gears and clutches which are operated by two air cylinders. These, in turn, are operated by an actuating

valve on a pedestal convenient to the motorman. The 200-H. P. engine has six 10-in. by 12-in. cylinders. Drive from crank shaft of engine to front axle is obtained by means of a sprocket carrying a 5-in. silent chain. The engine valves are of nickel-steel, 4 inches in diameter. Fig. 11 shows a number of front trucks of these cars equipped with engines.

Air for the brake system and other purposes is furnished by a pump driven by the engine, and also by an emergency independent gasoline-driven compressor installed in the engine room. This is shown in Fig. 12.

Combination Gasoline-Electric Railway Motor Cars. The General Electric Co. of Schenectady, N. Y., has built a type of gasoline-driven car which secures the flexibility of speed control peculiar to electric motors. The car is a double-truck car, the forward truck being equipped with two 50-H. P. railway motors. In the forward compartment of the car is located the power plant, consisting of a gasoline engine, of about 125-H. P. capacity, direct connected to an 8-pole, 80-kilowatt, 600-volt commutating pole generator and direct-coupled, $3\frac{1}{2}$ -kilowatt, 32-volt exciter. The prime mover is a four-cycle, eight-cylinder gasoline engine, with water jackets cast integral with cylinders. Valves are of nickel-steel. Engine-cooling is by means of the thermo-siphon circulation system, with radiators of the fin-tube variety having 2,000 sq. ft. cooling surface. The ignition system consists of a high-tension magneto and spark plugs. An air pump, driven from the main crank-shaft of the engine, supplies air for the brakes and whistle. Fig. 13 is a view of the interior of the cab showing the complete generating installation.

Speed control is on the motor, the engine running at constant speed. The electric controller is so designed that the motors may be placed progressively in series and parallel, and the voltage applied to the motors is controlled by varying the strength of the generator field. All this is done by merely moving the handle of the controller. The controller is provided with a reversing handle to change the polarity of the armature current in relation to the field current of the motors, and thus reverse the car. Substantial handles for spark and throttle control of the engine are also placed convenient to the motor controller. The cars are also constructed so that the same control will apply to either the self-contained power plant on the car,

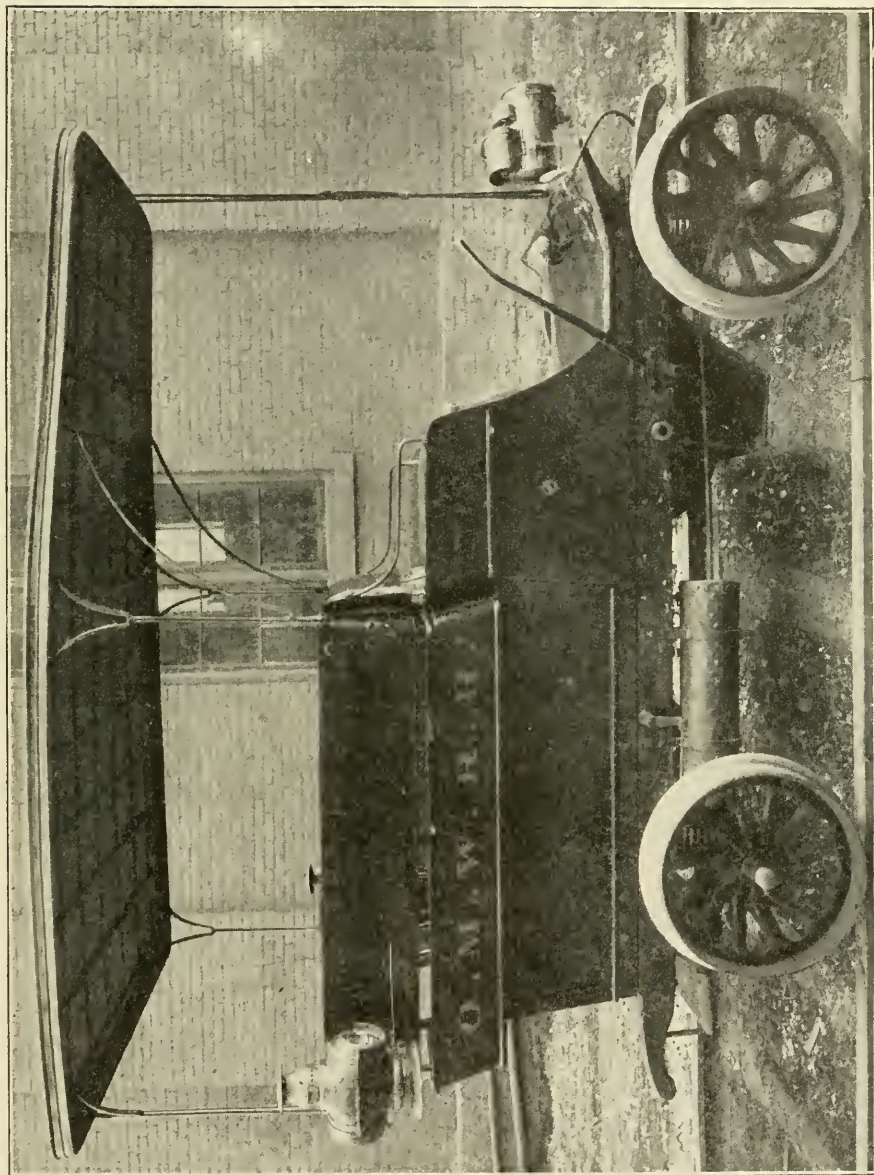

A RAILWAY INSPECTION CAR
Designed for self-propulsion along the tracks.

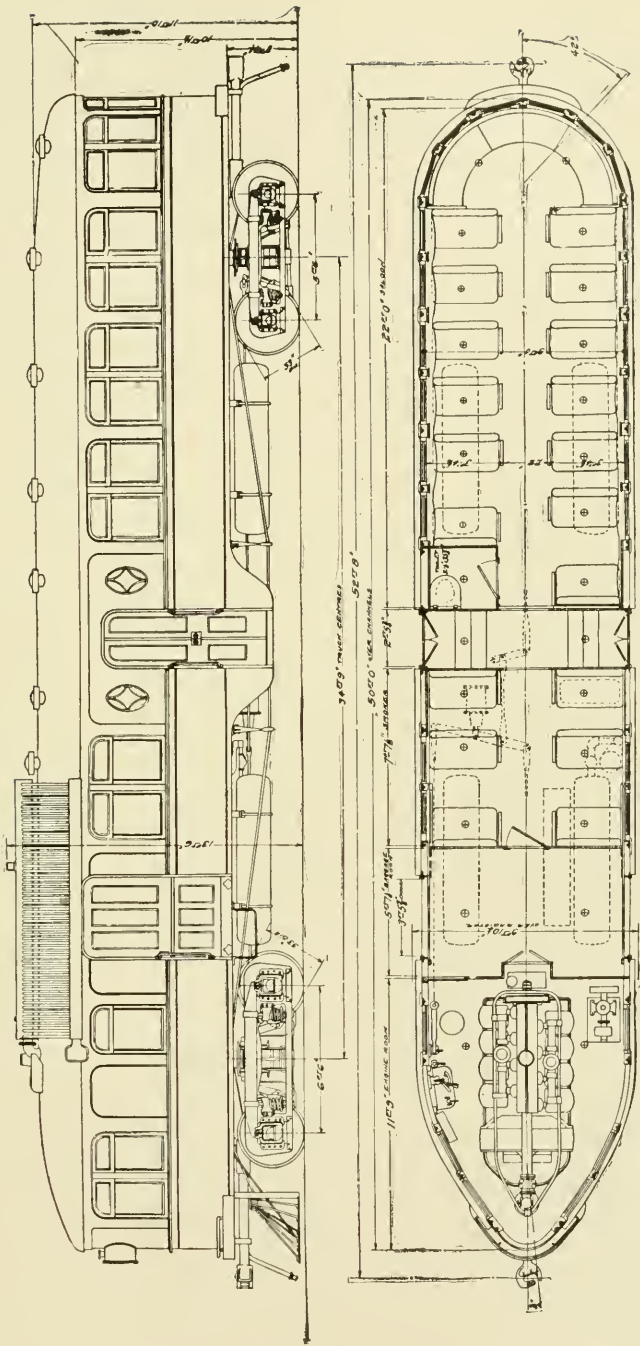

Fig. 16. Plan and Elevation of G. E. Gas-Electric Car.

or to power from a trolley when the car is transferred to a trolley line on part of the route. Fig. 14 shows the gasoline engine and direct-connected generator which constitute the power plant of the car.

The gasoline engine is started by compressed air from the main reservoir, through a distributing valve to the several cylinders in succession. For re-charging the reservoirs, if necessary when the main engine is shut down, a single-cylinder, single-acting air pump, direct-connected to a 4-H. P., single-cylinder, two-cycle gasoline engine, is provided in the engine compartment.

The car is heated from the exhaust gases of the gasoline engine by a system of hot water circulation on the thermo-siphon principle. Illumination is obtained by incandescent electric lights.

Fig. 15 is an exterior view of the General Electric Gas-Electric Car as above described. Fig. 16 is a diagram showing plan and elevation of the car.

Gasoline power with gear transmission is employed in the German Daimler, and the gasoline-electric system in the Weitzer car in Hungary, and on the North Eastern in England.

Self-Propelled Railway Coaches with Steam Power. This type of self-propelled railway coach has been developed on the European continent, notably in the Serpollet type of flash boiler with kerosene as fuel, and the Purrey type of superheating water-tube boiler with coal as fuel.

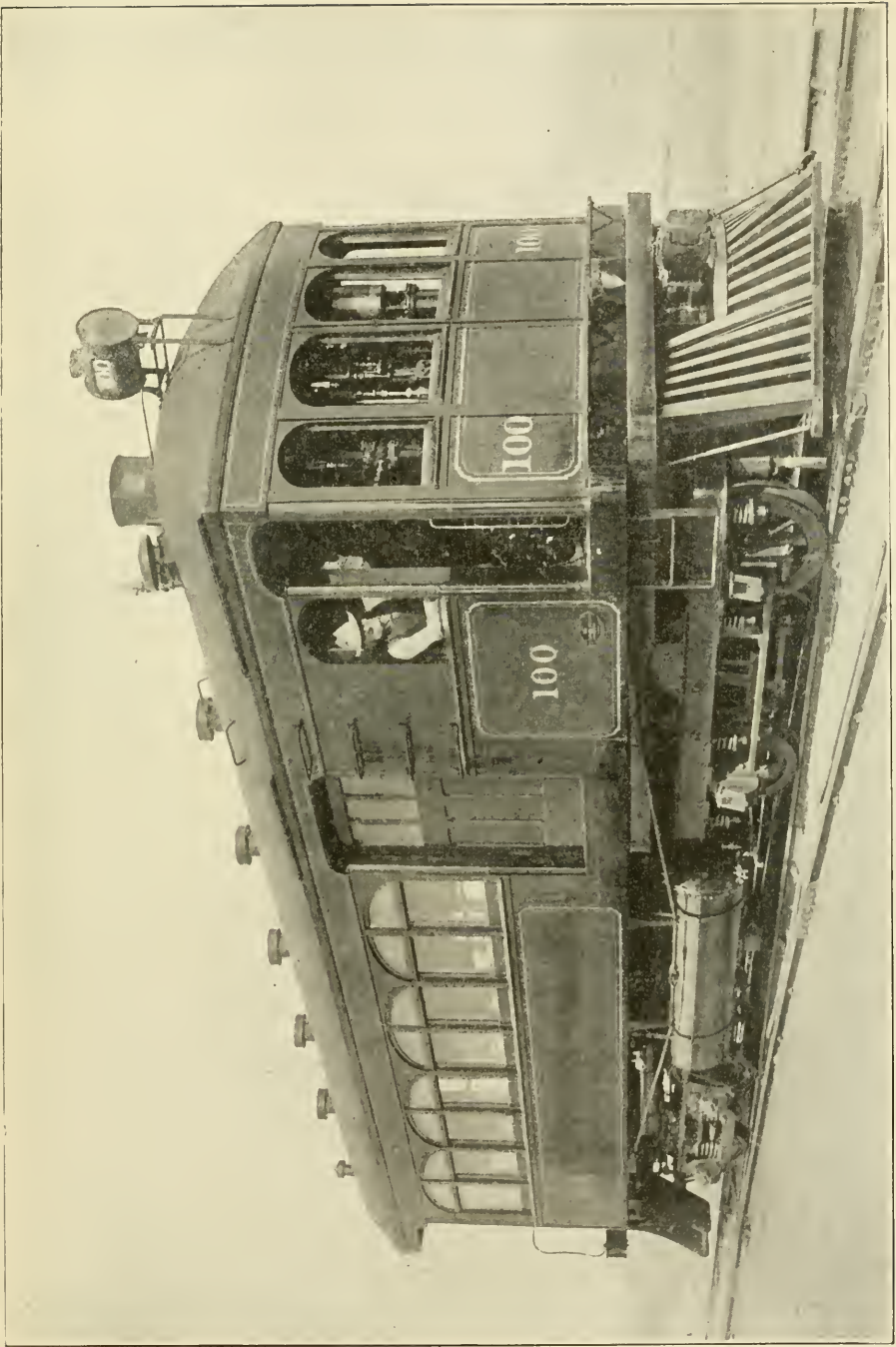

A STEAM-DRIVEN PASSENGER COACH
In This Car Are Combined the Locomotive, Tender, and Coach.

REVIEW QUESTIONS

REVIEW QUESTIONS
ON THE SUBJECT OF
POWER TRANSMISSION.

1. Of the various arrangements for obtaining the three-wire system, shown in Fig. 13, which is the one most commonly used in practice?

2. What is the drop in voltage and the loss in energy in a line 5 miles long composed of No. 6 wire, if the current flowing is 6.8 amperes?

3. What is the purpose of transposing wires? Explain the principles upon which transposition is based.

4. What materials are commonly used for conductors for electrical transmission of power?

5. What is the disadvantage of using the bridge arrangement for obtaining a three-wire system from a single generator?

6. Give the formula for calculating the area of conductor in circular mils of an alternating current transmission line, explaining the meaning of the symbols used.

7. What relation must exist between the capacity and self-induction of a line in order that the one may neutralize the other?

8. What is the area in square mils of a No. 3 wire?

9. Outline the method of determining the most economical feeding point for a system.

10. What limit determines the allowable rise in temperature in a conductor carrying current?

11. Show a sketch of the connections of the three-phase four-wire system.

12. Supposing a circuit has a capacity of .6 micro-farads, the frequency of the circuit being 25 cycles; what must be the inductance to exactly neutralize its capacity?

POWER TRANSMISSION

13. Without referring to the book, show a sketch of the anti-parallel system of feeding with tapering conductors.
14. For what purpose is aluminum used principally, and why?
15. To what sort of distribution is the series multiple system applicable?
16. Under what conditions is it more economical to use poly-phase systems than single-phase?
17. Give approximate values of power factor for incandescent lights alone and also for induction motors alone
18. If a No. 10 wire has a diameter of about $\frac{1}{10}$ th of an inch what would be the cross-sectional area of a No. 19 wire?
19. How do you account for the capacity effect which is present on transmission lines?
20. What is the principal advantage of multiple-wire systems?
21. How can the self-induction on a transmission line be reduced?
22. Mention uses to which the series system is applicable.
23. Which is preferable for long distance transmission, three phase or two-phase? Explain why.

REVIEW QUESTIONS

ON THE SUBJECT OF

ELECTRIC RAILWAYS

PART I

1. What mechanical problems are connected with the movement of cars?
2. Describe carefully the underframe of a car body.
3. Explain how a double-truck car body is "trussed."
4. Sketch a monitor-deck roof in cross-section, naming the different parts.
5. Describe the spring system in a single truck, mentioning the purpose of each set of springs.
6. Make a sketch of the side frame of a single truck, showing the motor suspension bars and springs.
7. Define the following terms used in connection with double trucks: *bolster*; *transom*; *spring plank*; *suspension links*; *kingbolt*; *pivot plate*; *side bearing*; *elliptical springs*; and *helical springs*.
8. How is the bolster cushioned against side blows?
9. Describe the construction of a short wheel-base truck.
10. How does the maximum traction truck differ from the M. C. B. truck?
11. Draw a standard car axle to scale from the table in Fig. 16.
12. Describe briefly a good axle steel.
13. Describe the journal box, bearing, and wedge and the relation of these to the journal.
14. Compare solid and split axle gears.
15. How is a railway motor made waterproof?
16. What provisions are made for inspection and repair

REVIEW QUESTIONS

ON THE SUBJECT OF

ELECTRIC RAILWAYS

PART II

1. Explain how a car is brought to rest.
2. How is it possible to apply two brake shoes by a tension in one rod?
3. Make a sketch showing how a brake head is hung and how the pressure is applied through a lever.
4. Sketch in diagram a simple brake rigging (levers, rods, etc.).
5. What are the advantages of the Peacock brake drum over the ordinary spindle?
6. What are the advantages to compensate for the greater expense of air brakes over hand brakes?
7. Explain the meanings of the terms "straight" and "automatic" as applied to air brakes.
8. Make a diagram of the apparatus used in a straight-air-brake equipment marking each part plainly.
9. Explain the construction of a compressor for an air-brake system.
10. Where are the valves located in the compressor and how do they work?
11. Explain from the illustration how the compressor is hung from the under side of the car.
12. Explain how the pump governor maintains a fairly uniform reservoir pressure.
13. Explain how the piston packing in the brake cylinder is arranged for air tightness.
14. Why is a hollow piston rod used in the brake cylinder?

REVIEW QUESTIONS

ON THE SUBJECT OF

ELECTRIC RAILWAYS

PART III

1. After an examination of Figs. 141 and 142, describe the nature of a railway load.
2. Why is the load of a large station steadier than that of a small one?
3. Give an original definition of the purpose of a power house.
4. Why is a power plant so inefficient?
5. What is the use of the equalizer connection between direct-current, compound-wound generators? Is this needed with shunt generators? Explain answer.
6. Make such sketches of the G. E. and I-T-E circuit breakers as will show that you understand their operating principles.
7. How must you proceed in preparing an estimate of the cost of generating electrical energy in a power plant?
8. What are the items which make up this cost?
9. How does the load factor affect the cost?
10. Why are substations used in railway systems?
11. Describe briefly a simple substation.
12. Make a sketch of a steel tower and explain the function of each part.
13. Describe the "pin" and "suspension" types of high-tension insulators.
14. What are the advantages of the "figure 8" and "grooved" sections of trolley wire over the round section?
15. Sketch separately the three parts of which the insulator shown in Fig. 182 is made up.

REVIEW QUESTIONS
ON THE SUBJECT OF
ELECTRIC RAILWAYS
PART IV

1. Make rough sketches of cross-sections of city and inter-urban track.
2. Describe the different rail sections in use in electric railway track. Give reasons for the increasing popularity of the T rail for city use.
3. Compare the different kinds of steel used for rails.
4. Why is the joint such an important part of a track?
5. Mention some of the joints used and give their characteristics.
6. Describe the welded joints and the mechanical joints, keeping in mind both mechanical and electrical features.
7. State briefly the essential features of the three kinds of welded joints.
8. Give reasons for the continued popularity of wooden ties.
9. What improvement is being made in the wooden tie? Name any details of track design which tend to increase the life of the ties.
10. What structural differences are necessary in applying wooden and steel ties?
11. What is the purpose of the ballast?
12. What is meant by the term "special work"?
13. Define the following terms: (a) *Mate*. (b) *Switch*. (c) *Frog*. (d) *Cross-over*. (e) *Cross*.
14. Sketch a small installation of special work, consisting of two double tracks cross-connected by one set of curves.

INDEX

INDEX

The page numbers of this volume will be found at the bottom of the pages; the numbers at the top refer only to the section

	Page		Page
A			
Air brakes	182	Alternating-current railway switch-board	275
air compressor	186	Annunciator wire	19
brake cylinder	194	Appendix	379
operating valve	195	Armature windings, defects in	248
piping	197	Atmospheric heater	262
pump governor	190	Automatic control	161
reservoir	193	Automotoneer	170
safety valve	198		
stopping car	202	B	
straight air brake	183	Ballast	342
air compressor	183	Block signals	324
brake-cylinder piston	183	automatic	326
chime whistle	183	hand-operated	325
governor	183	Bond testing	315
large reservoir	183	Bracket construction	305
operating of	183	Brakes and braking	177
operating valve	183	air brakes	182
piping system of	183	brake rigging on double-truck cars	180
safety-valve	183	Peacock brake	179
wiring, system of	183	Braking	233
train air signal	202		
Westinghouse automatic friction brake	200	C	
Air compressor	186	Cables	90
All-day efficiency	60	Capacity of circuits	39
Alternating-current lines	45	Car body	100
calculations	45	double-truck	103
general wiring formulas	46	frame	100
Alternating-current locomotives—		roof	106
polyphase	372	sides and ends	104
Great Northern	376	single-truck	103
polyphase traction motors	372	vestibule	106
Alternating-current locomotives—		Car equipment, miscellaneous	203
single phase	363	car wiring and equipment of cars	215
Grand Trunk	371	car-wiring systems	214
New Haven gearless	363	draw-bars and couplers	220

Note.—For page numbers see foot of pages.

	Page		Page
Car equipment, miscellaneous		Conductors	
electrical devices	225	material	11
canopy, or hood, switch	225	mechanical strength	13
car circuit breaker	226	weight	12
choke coil	228	resistance	13
fuses	226	effects of	17
lightning arresters	227	temperature coefficient	15
heaters	208	Conduit materials	86
electric	208	Contractors	154
hot-water	209	Controllers	147
lighting systems	211	control apparatus on a General	
head lights	212	Electric 1200-volt	
lamps	211	equipment	172
rheostats	224	manual	148
track sanders	225	preventing of fast feeding	
trolley	203	of	169
base	203	multiple-unit	153
catcher and retriever	207	Sprague-General Electric	
harp	206	control	153
pole	205	Westinghouse unit switch	
wheel	206	control	164
Car movement, mechanics of	230	Cost details of power plants	281
acceleration resistance	231	Cross-arms	73
braking	233	Current limit relay	170
coasting	234	Curve resistance	231
curve resistance	231	D	
grade resistance	231	Direct-current locomotives	353
principles of mechanics applied		New York Central	353
to car motors	235	Pennsylvania	358
acceleration curves	235	Direct-current machines	270
current curve	238	Direct-current railway switchboards	272
data from road tests	238	Dispatcher	323
distance curve	238	Distribution of power for heavy	
power curve	238	traction	376
Car-wiring system	214	Distribution systems	21
Catenary construction	307	alternating current	32
Circulating water	258	copper, amount of for differ-	
Coal circuit	257	ent systems	38
Coasting	234	parallel	33
Combination gasoline-electric railway		polyphase	37
motor cars	418	series	32
Common T-rail	332	voltage regulation	33
Conductors	11, 83	multiple circuit	28
current-carrying capacity	17	three-wire	28
insulation	18	generating	31
annunciator wire	19	neutral conduction	29
gutta-percha	21	voltage regulation	31

Note.—For page numbers see foot of pages.

	Page		Page
Distribution systems		H	
single circuit	21	Headlights	212
parallel	23	Heat and other energy transformations	260
anti-parallel	23	railway plant in modernizing process	263
feeders	23	St. Clair tunnel power plant	266
feeding	23	feed water	269
feeding point	25	forced draft	266
mains	23	fuel, handling of	266
series	21	superheated steam	269
series-multiple and multiple-series	28	turbines and generators	269
Double-truck gasoline railway motor cars	415	simple steam station	260
Draw-bars and couplers	220	small reciprocating engine plant	260
E		Heaters—car	208
Efficiency of transformer	60	electric	208
Electric locomotives	353	hot-water	209
alternating-current, polyphase	372	Heavy traction, distribution of power for	376
alternating-current, single phase	363	I	
direct-current	353	Inductance	40
Electric railways	97-379	Inspection motor cars	405
appendix	379	Insulation	18
engineering features	97	Insulators	73, 296
power plants	255	K	
rolling stock and equipment	98	Koehler trackless trolley system	392
steam railway electrification	351	L	
track construction	331	Light single-truck railway motor cars	412
transmission	288	Lighting system in electric railways	211
Electrolysis, prevention of	321	headlights	212
English railless trackless trolley system	395	lamps	211
F		Line protection	94
Feed water	257	Line stresses	76
Feeder systems	317	tension	78
Feeding point of mains	25	weight of wire	76
Filovia trackless trolley system	399	wind pressure	77
G		Load factor	284
Gasoline locomotives	409	M	
Girder rail	333	Manholes	88
Grade resistance	231	Manual controller	148
Grand Trunk locomotive	371	Manual controllers, preventing of fast feeding of	169
Great Northern locomotive	376	automotoneer	170
Guard rail	334	current limit relay	170
Gutta-percha	21		

Note.—For page numbers see foot of pages.

	Page		Page
Master controller	156	Motors	
Mercedes-Stoll trackless trolley system	387	direct-current series type	
Motor curves, use of	136	construction	
Motor heating	140	inter-pole	134
Motor and controller wiring, locat-		lead and connectors	132
ing defects in	242	railway motor, other	
miscellaneous	245	types of	132
armature tests for grounds	245	suspension	132
armature winding, defects in	248	motor heating	140
burn-outs	248	operating characteristics	135
car, failure of to start	252	reversal of rotation	145
field tests for grounds	245	speed control	142
grounds	247	Multiple-unit controller	153
motor-coil test	246	Mutual inductance	43
reversed fields	245		
sparkling at commutator	251	N	
winding armature, mistakes		New Haven gearless locomotive	363
in	250	New York Central locomotive	353
open circuits, tests for	242	Non-automatic control	157
short circuits, tests for	243		
Motor velocipedes	404	O	
Motors	124	Overhead construction	298
alternating-current type	145	bracket construction	305
alternating-current motors,		catenary construction	307
frequency for	147	span-wire construction	301
armature magnetomotive		trolley and fastenings	298
force, neutraliza-		clamp	300
tion of	146	ears	300
armature turns, increase of	146	hanger	299
high-resistance commutator		section insulators	300
leads, use of	146	Overhead lines	66
laminated field cores, use of	146	conductors	83
low motor voltage, use of	147	cross-arms	73
poles, increase in number of	146	insulators	73
reactance, reduction of	145	line stresses	76
direct-current series type	124	tension	78
construction	124	weight of wire	76
armature core and coils	127	wind pressure	77
bearings	130	location of line	67
brush and brush hold-		pins	76
ers	130	poles	68
commutator	129	guying	71
complete armature	130	inspection	70
field pole-cores and		preserving	70
coils	125	steel towers	72
gear case	132	taper	68
gearing	132		

Note.—For page numbers see foot of pages.

	Page		Page
P			
Parallel system of distribution	23	Rails	
Peacock brake	179	"trilby" or grooved	333
Pennsylvania locomotive	358	Railway plant in modernizing process	263
Poles	68	Reactance, reduction of	145
guying	71	Resistance of electrical conductors	13
inspection	70	effects of	17
preserving	70	temperature coefficient	15
size	68	Rheostats	224
taper	68	Rolling stock and equipment	98
Polyphase traction motors	372	brakes and braking	177
Porcelain insulators	74	car body	100
Power circuit	259	car movement, mechanics of	230
Power factor	48	controllers	147
Power house construction and arrangement	257	historical	98
circulating water	258	maintenance of	240
coal circuit	257	inspection	240
feed water	257	locating defects in motor	
power circuit	259	and controlling	
steam circuit	258	wiring	242
Power losses	60	oiling	240
Power plant	255	miscellaneous car equipment	203
characteristic features	257	motors	124
cost details of	281	trucks	108
electrical details of	270	S	
substations	284	St. Clair tunnel power plant	266
Power transmission	11-94	feed water	269
conductors	11	forced draft	266
alternating current	32	handling fuel	266
distributing systems	21	superheated steam	269
multiple circuit	28	turbines and generators	269
single circuit	21	Schiemann trackless trolley system	383
miscellaneous factors	93	Section or bridge gang car	406
overhead lines	66	Section motor car	406
transformers	59	Self-inductance	40
transmission lines	39	Self-propelled railway cars	403-422
underground construction	83	combination gasoline-electric cars	418
Pump governor	190	double-truck gasoline cars	415
R			
Rail joints	334	gasoline locomotives	409
Rails	332	inspection motor cars	405
common T	332	light single-truck cars	412
composition of	334	motor velocipedes	404
girder	332	section or bridge gang car	406
guard	334	section motor cars	406
Shanghai T	332	self-propelled railway coaches	
		with steam power	422
		Series system of distribution	21

Note.—For page numbers see foot of pages.

	Page		Page
Shanghai T-rail	332	Tables	
Signal systems	323	motor efficiencies for different	
block signals	324	track grades	139
automatic	326	pure aluminum wire, resistances	
hand-operated	325	of	14
dispatcher	323	rail resistance data	319
Span wire construction	301	temperature effects in spans	79
Sparking at the commutator	251	transmission line factors, data	
"Special work"	342	for calculating	37
Sprague-General Electric Control	153	wires, safe carrying capacity of	16
automatic control	161	Temperature coefficient	15
contactors	154	Thermit welding	338
control-circuit cut-out switch	155	Ties	339
interlocks, or auxiliary contacts	155	Third-rail construction	310
main circuit breaker	155	bonding	312
master controller	156	protection	311
non-automatic control	157	supports	310
control circuits	159	Third-rail supports	310
motor circuits	157	Track construction	331
reverser	156	rail joints	334
train line	153	rails	332
Steam circuit	253	special track construction	350
Steam railway electrification	351	"special work"	342
distribution of power for heavy		track support	339
traction	376	Track as return circuit	312
electric locomotives	353	bond testing	315
Straight air brake	183	bonding systems	312
Strain insulator	302	supplementary return conduct-	
Stray currents from electric railways	319	ors	317
Substations	285	Track, resistance of	315
	T	Track sanders	225
Tables		Track support	339
cable construction	92	ballast	342
capacity in microfarads per mile		ties	339
of circuit for three-		Trackless trolley traction	381-401
phase system	41	systems	383
car heating data	210	American installations	401
conductors, class of, for various		English railless	395
positions	20	Filovia	399
conductors for various condi-		Koehler	392
tions	20	Mercedes-Stoll	387
copper, temperature coefficients		Schiemann	383
for	15	unique features and advantages	381
copper wire	12	applicability	382
heat tests on Brooklyn cars	210	current consumption	382
inductance per mile of three-		mobility	382
phase circuit	42	roadways	381

Note.—For page numbers see foot of pages.

	Page		Page
Trackless trolley traction		Trucks	
unique features and advantages		truck details	114
trackless feature	381	axle gears	122
weight	381	axles	115
Train air signal	202	brake shoes	118
Train line	156	car wheels	120
Transformers	59	journal boxes and bearings	116
connections	63	wheel treads and flanges	120
efficiency	60	wrought-iron bars for elec-	
frequency, choice of	65	tric railway pur-	
power losses	60	poses	123
regulation	62		
Transmission	288	U	
distributing system	298	Underground conduit system	350
overhead construction	298	Underground construction	83
feeder systems	317	cables	90
insulators	296	conduit materials	86
poles and towers	292	earthenware	87
signal systems	323	wood	86
stray currents from electric		wrought iron	86
railways	319	manholes	88
third-rail construction	310	systems	83
track as return circuit	312	drawing-in	86
wires	288	Siemens Halske	85
Transmission lines	39	solid, or built-in	83
alternating-current lines	45	trench	85
capacity	39	Unit switch	165
inductance	40		
mutual	43	V	
self	40	Voltage regulation	31
"Trilby" or grooved rail	333	Voltage, selection of	93
Trolley	203		
base	203	W	
catcher	207	Welded joints	336
harp	206	cast-welded	337
retriever	208	electrically-welded	337
wheel	206	thermit welding	338
Trolley and fastenings	298	Westinghouse automatic friction	
clamp	300	brake	200
hanger	299	Westinghouse unit switch control	164
section insulators	300	air supply	167
Trucks	108	control of motor circuits	167
double	110	unit switch	165
general principles	110	Winding armatures, mistakes in	250
maximum traction	113	Wrought-iron bars, specifications for	123
short wheel-base	112		
single	108		

Note.—For page numbers see foot of pages.



